



jet.com.ua

# EASTERN-EUROPEAN JOURNAL OF ENTERPRISE TECHNOLOGIES

ISSN 1729-3774



информационные технологии

інформаційні технології

information  
technologies

новая экономика

нова економіка

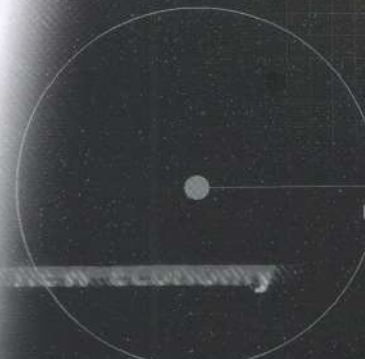

промышленные технологии

промислові технології

industrial  
applications

1/9 (97)  
2019



- Information and controlling systems

## 1/9 (97) 2019 Content

### INFORMATION AND CONTROLLING SYSTEMS

- 6 Improving the model of decision making about abnormal network state using a positioning system  
**I. Antipov, T. Vasilenko**
- 11 Development of procedures for determining the parameters of an aircraft servo actuator  
**E. Kononykhin**
- 19 Testing of measurement instrument software with the purpose of conformity assessment  
**O. Velychko, V. Gaman, T. Gordiyenko, O. Hrabovskyi**
- 27 Development of niederreiter hybrid crypto-code structure on flawed codes  
**S. Yevseiev, O. Tsyhanenko, A. Gavrilova, V. Guzhva, O. Milov, V. Moskalenko, I. Opirskyy, O. Roma, B. Tomashevsky, O. Shmatko**
- 38 The development of methods for determining vibration stochastic fields of technological complexes  
**N. Marchenko, O. Monchenko, G. Martyniuk**
- 48 Comprehensive approach to modeling dynamic processes in the system of underground rail electric traction  
**S. Yatsko, B. Sytnik, Y. Vashchenko, A. Sidorenko, B. Liubarskyi, I. Veretennikov, M. Glebova**
- 58 Development of the algorithm of video image adaptation to spectral power distribution of illuminants  
**V. Pyliavskyi**
- 68 Designing adaptive PID controller non-sensitive to changes in aerodynamic characteristics of an unmanned aerial vehicle  
**O. Boudiba, S. Firsov**
- 76 Abstract&References



## ГОЛОВНИЙ РЕДАКТОР

**Дьомін Дмитро Олександрович**

д. т. н., професор Національного технічного університету «Харківський політехнічний інститут»,  
директор ПП «Технологічний Центр», Харків (Україна)

**Терзіян Ваган Якович**

д. т. н., професор Університету Ювяскюля (Фінляндія)

## РЕДАКЦІЙНА КОЛЕГІЯ

### ВИРОБНИЧО-ТЕХНОЛОГІЧНІ СИСТЕМИ

**Awrejcewicz Jan**, Professor of Lodz University of Technology, Lodz (Poland); **Korzhyk Volodymyr**, Doctor of Technical Sciences, Chinese-Ukrainian E. O. Paton Welding Institute (CUPWI), Guangzhou (China); **Marcin Kamiński**, Professor of Lodz University of Technology, Lodz (Poland); **Shen Houfa**, Professor of Tsinghua University, Beijing (China); **Ulusoy Uğur**, Professor of Cumhuriyet Universitesi, Sivas (Turkey); **Загірняк М. В.**, д. т. н., проф., Кременчуцький національний університет імені Михайла Остроградського, Кременчук (Україна); **Залогов В. О.**, д. т. н., проф., Сумський державний університет, Суми (Україна); **Кіндрачук М. В.**, д. т. н., проф., Національний авіаційний університет, Київ (Україна)

### ІНФОРМАЦІЙНІ ТЕХНОЛОГІЇ. СИСТЕМИ УПРАВЛІННЯ В ПРОМИСЛОВОСТІ

**Cardoso Jorge**, Professor of University of Coimbra, Faculty of Science and Technology, Coimbra (Portugal); **Iyengar Sitharama**, Professor of Florida International University, Miami, (USA); **Jakab Frantisek**, Associate Professor of Technical University of Kosice, Department of Computers and Informatics, Kosice (Slovak Republic); **Omelayenko Borys**, PhD, Senior Software Engineer at Elsevier Amsterdam Area, Amsterdam (Netherlands); **Terziyan Vagan**, Professor of University of Jyväskylä, Department of Mathematical Information Technology, Jyväskylä (Finland); **Wrycza Stanislaw**, Professor of Uniwersytet Gdanski, Gdańsk (Poland); **Жолткевич Г. М.**, д. т. н., проф., Харківський національний університет імені В. Н. Каразіна, Харків (Україна); **Лакно В. А.**, д. т. н., проф., Європейський університет, Київ (Україна); **Литвин В. В.**, д. т. н., проф., Національний університет «Львівська політехніка», Львів (Україна); **Остапов С. Е.**, д. ф.-м. н., проф., Чернівецький національний університет імені Юрія Федьковича, Чернівці (Україна); **Пелещишин А. М.**, д. т. н., проф., Національний університет «Львівська політехніка», Львів (Україна); **Теслюк В. М.**, д. т. н., проф., Національний університет «Львівська політехніка», Львів (Україна)

### ПРОЦЕСИ УПРАВЛІННЯ

**Rab Nawaz Lodhi**, PhD, COMSATS Institute of Information Technology Sahiwal Campus (Pakistan); **Бутько Т. В.**, д. т. н., проф., Український державний університет залізничного транспорту, Харків (Україна); **Гогунський В. Д.**, д. т. н., проф., Одеський національний політехнічний університет, Одеса (Україна); **Дьомін Д. О.**, д. т. н., проф., Національний технічний університет «Харківський політехнічний інститут», директор ПП «Технологічний Центр», Харків (Україна); **Мямлін С. В.**, д. т. н., проф., Дніпропетровський національний університет залізничного транспорту, Дніпро (Україна); **Панченко С. В.**, д. т. н., проф., Український державний університет залізничного транспорту, Харків (Україна); **Проخورченко А. В.**, д. т. н., проф., Український державний університет залізничного транспорту, Харків (Україна); **Сіра О. В.**, д. т. н., проф., Національний технічний університет «Харківський політехнічний інститут», Харків (Україна)

### МАТЕМАТИКА ТА КІБЕРНЕТИКА - ПРИКЛАДНІ АСПЕКТИ

**Ahmad Izhar**, Associate Professor of King Fahd University of Petroleum and Minerals, Department of Mathematics and Statistics, Dhahran (Saudi Arabia); **Hari Mohan Srivastava**, Professor University of Victoria, Department of Mathematics and Statistics, Victoria (Canada); **Kanellopoulos Dimitris**, PhD, University of Patras, Patra (Greece); **Trujillo Juan J.**, Professor of Universidad de la Laguna, Faculty of Mathematics, San Cristobal de La Laguna (Spain); **Weber Gerhard Wilhelm**, Professor of Middle East Technical University, Institute of Applied Mathematics, Ankara (Turkey); **Атаманюк І. П.**, д. т. н., проф., Миколаївський національний аграрний університет, Миколаїв (Україна); **Кондратенко Ю. П.**, д. т. н., проф., Чорноморський національний університет імені Петра Могили, Миколаїв (Україна); **Романова Т. Є.**, д. т. н., проф., Інститут проблем машинобудування ім. А. М. Підгорного НАН України, Харків (Україна); **Саваневич В. Є.**, д. т. н., проф., Державне космічне агентство України, Київ (Україна)

### ПРИКЛАДНА ФІЗИКА

**Bobitski Yaroslav**, Professor of University of Rzeszow, Department of mechatronics, Rzeszów (Poland); **Machado Jose Antonio Tenreiro**, Professor of Polytechnic of Porto, Institute of Engineering, Department of Electrical Engineering (Portugal); **Magafas Lykourgos**, Professor of Eastern Macedonia & Thrace Institute of Technology, Greece; **Nerukh Dmitry**, Senior Lecturer Aston University, Birmingham (United Kingdom); **Pavlenko Anatoliy**, Professor of Kielce University of Technology, Department of Building Physics and Renewable Energy Kielce (Poland); **Вовк Р. В.**, д. ф.-м. н., проф., Харківський національний університет імені В. Н. Каразіна, Харків (Україна); **Гламаздін О. В.**, к. ф.-м. н., старший науковий співробітник, Національний науковий центр «Харківський фізико-технічний інститут», Харків (Україна); **Гришанов М. І.**, д. ф.-м. н., проф., Український державний університет залізничного транспорту, Харків (Україна); **Желєзний В. П.**, д. т. н., проф., Одеська національна академія харчових технологій, Одеса (Україна); **Ільчук Г. А.**, д. ф.-м. н., проф., Національний університет «Львівська політехніка», Львів (Україна); **Мар'янчук П. Д.**, д. ф.-м. н., проф., Чернівецький національний університет ім. Ю. Федьковича, Чернівці (Україна); **Маслов В. П.**, д. т. н., проф., Національний технічний університет України «Київський політехнічний інститут імені Ігоря Сікорського», Київ (Україна); **Старіков В. В.**, к. ф.-м. н., доцент, Національний технічний університет «Харківський політехнічний інститут», Харків (Україна); **Ткаченко В. І.**, д. ф.-м. н., проф., Харківський національний університет імені В. Н. Каразіна, Харків (Україна); **Ціж Б. Р.**, д. т. н., проф., Львівський національний університет ветеринарної медицини та біотехнологій імені С. З. Гжицького, Львів (Україна)



## ТЕХНОЛОГІЇ ОРГАНІЧНИХ ТА НЕОРГАНІЧНИХ РЕЧОВИН

**Martins Luisa**, Associate Professor of Universidade de Lisboa, Lisbon (Portugal); **Arvidas Galdikas**, Professor Kaunas University of Technology, Department of Physics, Kaunas (Lithuania); **Carda Juan B.**, Professor of Universidad Jaume I, Department of Inorganic Chemistry, Castellon de la Plana (Spain); **Gerasimchuk Nikolay**, Professor of Missouri State University, Springfield (United States); **Rotaru Andrei**, Professor of University of Craiova (Craiova); **Sprynsky Myroslaw**, Nicolaus Copernicus University in Torun, Department of Environmental Chemistry and Bioanalytics, Torun (Poland); **Zeng Liang**, Tianjin University, Tianjin (China); **Барсуков В. З.**, д. х. н., проф., Київський національний університет технологій та дизайну, Київ (Україна); **Вахула Я. І.**, д. т. н., проф., Національний університет «Львівська політехніка», Львів (Україна); **Дорошенко А. О.**, д. х. н., проф., Харківський національний університет імені В. Н. Каразіна, Харків (Україна); **Калуштин О. Є.**, д. х. н., проф., Приазовський державний технічний університет, Маріуполь (Україна); **Колосов О. Є.**, д. т. н., Національний технічний університет України «Київський політехнічний інститут імені Ігоря Сікорського», Київ (Україна); **Кривенко П. В.**, д. т. н., проф., Київський національний університет будівництва і архітектури, Київ (Україна); **Плаван В. П.**, д. т. н., проф., Київський національний університет технологій та дизайну, Київ (Україна); **Рошаль О. Д.**, д. х. н., Харківський національний університет імені В. Н. Каразіна, Харків (Україна); **Сухий К. М.**, д. т. н., проф., Український державний хіміко-технологічний університет, Дніпро (Україна); **Чумах В. Л.**, д. х. н., проф., Національний авіаційний університет, Київ (Україна)

## ПРИКЛАДНА МЕХАНІКА

**Aifantis Elias**, Aristotle University of Thessaloniki, Thessaloniki (Greece); **Andrianov Igor**, Professor of RWTH Aachen University, Department of General Mechanics, Aachen (Germany); **Lewis Roland W.**, Swansea University, Swansea (United Kingdom); **Sapountzakis Evangelos**, National Technical University of Athens, Athens (Greece); **Tornabene Francesco**, University of Bologna, Bologna (Italy); **Uchino Kenji**, Pennsylvania State University, University Park (USA); **Visser, Frank C.**, Flowserve, Etten-Leur (Netherlands); **Аврамов К. В.**, д. т. н., проф., Інститут проблем машинобудування ім. А. М. Підгорного Національної академії наук України, Харків (Україна); **Астанін В. В.**, д. т. н., проф., Національний авіаційний університет, Київ (Україна); **Ахундов В. М.**, д. ф.-м. н., професор, Національна металургійна академія України, Дніпро (Україна); **Легеза В. П.**, д. т. н., проф., Національний технічний університет України «Київський політехнічний інститут імені Ігоря Сікорського», Київ (Україна); **Львов Г. І.**, д. т. н., проф., Національний технічний університет «Харківський політехнічний інститут», Харків (Україна); **Пукач П. Я.**, д. т. н., проф., Національний університет «Львівська політехніка», Львів (Україна); **Ромульдович С. І.**, д. т. н., проф., Національний авіаційний університет, Київ (Україна); **Філімоніхін Г. Б.**, д. т. н., проф., Центральноукраїнський національний технічний університет, Кропивницький (Україна); **Фомичов П. О.**, д. т. н., проф., Національний аерокосмічний університет ім. М. Є. Жуковського «Харківський авіаційний інститут», Харків (Україна); **Ярошевич М. П.**, д. т. н., проф., Луцький національний технічний університет, Луцьк (Україна)

## ЕНЕРГОЗБЕРІГАЮЧІ ТЕХНОЛОГІЇ ТА ОБЛАДНАННЯ

**Acaroglu Mustafa**, Selcuk Universitesi, Konya (Turkey); **Besagni Giorgio**, Ricerca sul Sistema Energetico, Milan (Italy); **Calise Francesco**, Universita degli Studi di Napoli Federico II, Naples (Italy); **Guerrero Josep M.**, Aalborg Universitet, Aalborg (Denmark); **Li Haiwen**, Kyushu University, Fukuoka (Japan); **Ma Zhenjun**, University of Wollongong, Wollongong (Australia); **Morosuk Tatiana**, Technical University of Berlin, Berlin (Germany); **Popescu Mihaela**, University of Craiova Craiova (Romania); **Santamouris Mattheos**, University of New South Wales, Sydney (Australia); **Sutikno Tole**, Professor of Universitas Ahmad Dahlan, Department of Electrical Engineering, Yogyakarta (Indonesia); **Авраменко А. О.**, д. т. н., проф., Інститут технічної теплофізики Національної академії наук України, Київ (Україна); **Єрохов В. Ю.**, д. т. н., проф., Національний університет «Львівська політехніка», Львів (Україна); **Любарський Б. Г.**, д. т. н., проф., Національний технічний університет «Харківський політехнічний інститут», Харків (Україна); **Русанов А. В.**, д. т. н., проф., Інститут проблем машинобудування ім. А. М. Підгорного Національної академії наук України, Харків (Україна); **Терещенко Т. О.**, д. т. н., проф., Національний технічний університет України «Київський політехнічний інститут», Київ (Україна); **Фіалко Н. М.**, д. т. н., проф., Інститут технічної теплофізики Національної академії наук України, Київ (Україна)

## ІНФОРМАЦІЙНО-КЕРУЮЧІ СИСТЕМИ

**Sattarova Ulkar Eldar**, Associate Professor Azerbaijan University of Architecture and Construction, Department of Information technologies and systems, Baku (Azerbaijan); **Starovoitov Valery**, Professor, Doctor of sciences, United Institute of Informatics Problems, National Academy of Sciences of Belarus, Minsk (Belarus); **Безрук В. М.**, д. т. н., проф., Харківський національний університет радіоелектроніки, Харків (Україна); **Величко О. М.**, д. т. н., професор, Державне підприємство «Укрметрестандарт», Київ (Україна); **Уривський Л. О.**, д. т. н., проф., Національний технічний університет України «Київський політехнічний інститут імені Ігоря Сікорського», Київ (Україна); **Щербаківа Г. Ю.**, д. т. н., доцент, Одеський національний політехнічний університет, Одеса (Україна); **Яцків В. В.**, д. т. н., доцент, Тернопільський національний економічний університет, Тернопіль (Україна)

## ЕКОЛОГІЯ

**Kisi Ozgur**, Iliia State University, Tbilisi (Georgia); **Makarynsky Oleg**, Australian Institute of Marine Science (Australia); **Scholz Miklas**, Lunds Universitet, Lund (Sweden); **Бойченко С. В.**, д. т. н., проф., Національний авіаційний університет, Київ (Україна); **Гомеля М. Д.**, д. т. н., проф., Національний технічний університет України «Київський політехнічний інститут імені Ігоря Сікорського», Київ (Україна); **Ремез Н. С.**, д. т. н., Національний технічний університет України «Київський політехнічний інститут імені Ігоря Сікорського», Київ (Україна); **Шведчикова І. О.**, д. т. н., проф., Київський національний університет технологій та дизайну, Київ (Україна)

## ТЕХНОЛОГІЇ ТА ОБЛАДНАННЯ ХАРЧОВИХ ВИРОБНИЦТВ

**Adegoke Gabriel**, Professor of University of Ibadan, Department of Food Technology, Ibadan (Nigeria); **Barreca Davide**, Universita degli Studi di Messina, Messina (Italy); **Effat Baher**, National Research Centre, Cairo (Egypt); **Erkmen Osman**, Gaziantep Universitesi, Gaziantep (Turkey); **Hafiz Ansar Rasul Suleria**, PhD, Kansas State University, Department of Food, Nutrition, Dietetics and Health, Manhattan (USA); **Modi Vinod**, Central Food Technological Research Institute India, Fish and Poultry Technology, Mysore (India); **Бурдо О. Г.**, д. т. н., проф., Одеська національна академія харчових технологій, Одеса (Україна); **Павлюк Р. Ю.**, д. т. н., проф., Харківський державний університет харчування та торгівлі, Харків (Україна)

## МАТЕРІАЛОЗНАВСТВО

**Apostolopoulos Charis**, Patras University, Patra (Greece); **Gubicza Jenő**, Eötvös Loránd University, Budapest (Hungary); **Gupta Manoj**, National University of Singapore, Singapore City (Singapore); **Букетов А. В.**, д. т. н., проф., Херсонська державна морська академія, Херсон (Україна); **Геворкян Е. С.**, д. т. н., проф., Український державний університет залізничного транспорту, Харків (Україна); **Дубок В. А.**, д. х. н., проф., Київський національний університет імені Тараса Шевченка, Київ (Україна); **Дурягіна З. А.**, д. т. н., проф., Національний університет «Львівська політехніка», Львів (Україна); **Єфременко В. Г.**, д. т. н., проф., ДВНЗ «Приазовський державний технічний університет», Маріуполь (Україна); **Соболь О. В.**, д. ф.-м. н., проф., Національний технічний університет «Харківський політехнічний інститут», Харків (Україна); **Яремій І. П.**, д. ф.-м. н., проф., Прикарпатський національний університет імені Василя Стефаника, Івано-Франківськ (Україна)



## EDITOR IN CHIEF

**Demin Dmitriy**

Professor of the National Technical University «Kharkiv Polytechnic Institute»,  
Director of Private Company «Technology Centers», Kharkiv (Ukraine)

**Terziyan Vagan**

Professor of the University of Jyväskylä (Finland)

## EDITORIAL BOARD

### ENGINEERING TECHNOLOGICAL SYSTEMS

**Awrejcewicz Jan**, Professor of Lodz University of Technology, Department of Automation, Biomechanics and Mechatronics, Lodz (Poland); **Kindrachuk Myroslav**, Professor of National Aviation University, Department of Tribological material science, powder metallurgy, functional materials, Kyiv (Ukraine); **Korzhyk Volodymyr**, Doctor of Technical Sciences, Director of the Chinese-Ukrainian E. O. Paton Welding Institute (CUPWI), Guangzhou (China); **Marcin Kamiński**, Professor of Lodz University of Technology, Department of Structural Mechanics, Lodz (Poland); **Ulusoy Ugur**, Professor of Cumhuriyet Universitesi, Department of Mining Engineering, Sivas (Turkey); **Shen Houfa**, Professor of Tsinghua University, School of Materials Science and Engineering, Beijing (China); **Zagirnyak Mykhaylo**, Professor of Kremenchuk Mykhailo Ostrohradskiy National University, Department of electric machines and apparatus, Kremenchuk (Ukraine); **Zaloga Viliam**, Professor of Sumy State University, Department of manufacturing engineering, machines and tools, Sumy (Ukraine)

### INFORMATION TECHNOLOGY. INDUSTRY CONTROL SYSTEMS

**Cardoso Jorge**, Professor of University of Coimbra, Faculty of Science and Technology, Coimbra (Portugal); **Iyengar Sitharama Sitharama**, Professor of Florida International University, School of Computing and Information Sciences, Miami (USA); **Jakab Frantisek**, Associate Professor of Technical University of Kosice, Department of Computers and Informatics, Kosice (Slovak Republic); **Lakhno Valeriy**, Professor of European University, Department of Managing Information Security, Kyiv (Ukraine); **Lytvyn Vasyly**, Professor of Lviv Polytechnic National University, Department of Information Systems and Networks, Lviv (Ukraine); **Omelayenko Borys**, PhD, Senior Software Engineer at Elsevier Amsterdam Area, Amsterdam (Netherlands); **Ostapov Serhii**, Professor of Yuri Fedkovych Chernivtsi National University, Department of Computer systems software, Chernivtsi (Ukraine); **Peleshchysyn Andriy**, Professor of Lviv Polytechnic National University, Department of social communication and information activities, Lviv (Ukraine); **Terziyan Vagan**, Professor of University of Jyväskylä, Department of Mathematical Information Technology, Jyväskylä (Finland); **Teslyuk Vasyly**, Professor of Lviv Polytechnic National University, Department of Automated Control Systems, Lviv (Ukraine); **Wrycza Stanislaw**, Professor of Uniwersytet Gdanski, Department of Business Informatics, Gdańsk (Poland); **Zholtkevych Grygoriy**, Professor of Karazin Kharkiv National University, Department of Theoretical and Applied Computer Science of School of Mathematics and Computer Science, Kharkiv (Ukraine)

### CONTROL PROCESSES

**Butko Tatiana**, Professor of Ukrainian State University of Railway Transport, Department of operational work and international transportation, Kharkiv (Ukraine); **Demin Dmitriy**, Professor of National Technical University «Kharkiv Polytechnic Institute», director of the Private Company «Technology Centers», Kharkiv (Ukraine); **Gogunsky Viktor**, Professor of Odessa National Polytechnic University, Department of Management of life safety systems, Odessa (Ukraine); **Myamlin Sergey**, Professor of Dnipropetrovsk National University of Rail Transport, Dnipro (Ukraine); **Panchenko Sergii**, Professor of Ukrainian State University of Railway Transport, Department of Automatic and computer remote control of train traffic, Kharkiv (Ukraine); **Prokhorchenko Andrii**, Professor of Ukrainian State University of Railway Transport, Department of Operational Work Management, Kharkiv (Ukraine); **Rab Nawaz Lodhi**, PhD, COMSATS Institute of Information Technology Sahiwal Campus (Pakistan); **Sira Oksana**, Professor of National Technical University «Kharkiv Polytechnic Institute», Department of distributed information systems and cloud technologies, Kharkiv (Ukraine)

### MATHEMATICS AND CYBERNETICS - APPLIED ASPECTS

**Ahmad Izhar**, Associate Professor of King Fahd University of Petroleum and Minerals, Department of Mathematics and Statistics, Dhahran (Saudi Arabia); **Atamanyuk Igor**, Professor Mykolaiv National Agrarian University, Department of Higher and Applied Mathematics, Mykolaiv (Ukraine); **Hari Mohan Srivastava**, Professor University of Victoria, Department of Mathematics and Statistics, Victoria (Canada); **Kanellopoulos Dimitris**, PhD, University of Patras, Department of Mathematics, Patra (Greece); **Kondratenko Yuriy**, Professor Petro Mohyla Black Sea National University, Department of Intelligent Information Systems, Mykolaiv (Ukraine); **Romanova Tetyana**, Professor Institute for Problems in Machinery of National Academy of Sciences of Ukraine, Department of Mathematical Modeling and Optimal Design, Kharkiv (Ukraine); **Savanevych Vadym**, Professor State Space Agency of Ukraine, Kyiv (Ukraine); **Trujillo Juan J.**, Professor of Universidad de la Laguna, Faculty of Mathematics, San Cristobal de La Laguna (Spain); **Weber Gerhard Wilhelm**, Professor of Middle East Technical University, Institute of Applied Mathematics, Ankara (Turkey)

### APPLIED PHYSICS

**Bobitski Yaroslav**, Professor of University of Rzeszow, Department of mechatronics, Rzeszów (Poland); **Glamazdin Alexander**, PhD, National Science Center «Kharkov Institute of Physics and Technology», Kharkiv (Ukraine); **Grishanov Nikolay**, Professor of Ukrainian State University of Railway Transport, Department of Physics of plasmas, Controlled Nuclear Fusion, Kharkiv (Ukraine); **Ilchuk Hryhoriy**, Professor of Lviv Polytechnic National University, Department of General Physics, Lviv (Ukraine); **Machado Jose Antonio Tenreiro**, Professor of Polytechnic of Porto, Institute of Engineering, Department of Electrical Engineering, (Portugal); **Magafas Lykourgos**, Professor of Eastern Macedonia & Thrace Institute of Technology, Department of Electrical Engineering (Greece); **Maryanchuk Pavlo**, Professor of Yuriy Fedkovych Chernivtsi National University, Department of Physics, (Ukraine); **Maslov Volodymyr**, Professor of National Technical University of Ukraine «Igor Sikorsky Kyiv Polytechnic Institute», Department of Scientific, analytic and ecological instruments and systems, Kyiv (Ukraine); **Nerukh Dmitriy**, Senior Lecturer Aston University, Department of Mathematics, Birmingham, United Kingdom; **Pavlenko Anatoliy**, Professor of Kielce University of Technology, Department of Building Physics and Renewable Energy, Kielce (Poland); **Starikov Vadim**, Associate Professor of National Technical University «Kharkiv Polytechnic Institute», Department of Physics of metals and semiconductors, Kharkiv (Ukraine); **Tkachenko Viktor**, Professor of V. N. Karazin Kharkiv National University, Department of Physics of Innovative Energy & Technology & Ecology, Kharkiv (Ukraine); **Tsizh Bohdan**, Professor of Stepan Gzhytskyi National University of Veterinary Medicine and Biotechnologies Lviv, Department of General Technical Subjects and Production Quality Control, Lviv (Ukraine); **Vovk Ruslan**, Professor of Karazin Kharkiv National University, Department of low temperature physics, Kharkiv (Ukraine); **Zhelezny Vitaly**, Professor of Odessa National Academy of Food Technologies, Department of Thermal Physics and Applied Ecology, Odessa (Ukraine)

### TECHNOLOGY ORGANIC AND INORGANIC SUBSTANCES

**Arvaidas Galdikas**, Professor Kaunas University of Technology, Department of Physics, Kaunas (Lithuania); **Barsukov Viacheslav**, Professor Kyiv National University of Technologies and Design, Department for Electrochemical Power Engineering and Chemistry, Kyiv (Ukraine); **Carda Juan B.**, Professor of Universidad Jaume I, Department of Inorganic Chemistry, Castellon de la Plana (Spain); **Chumak Vitaly**, Professor of National Aviation University, Department of Chemistry and Chemical Engineering, Kyiv (Ukraine); **Doroshenko Andrey**, V. N. Karazin Kharkiv National University, Department of organic chemistry, Kharkov (Ukraine); **Gerashimchuk Nikolay**, Professor of Missouri State University, Department of Chemistry, Springfield (United States); **Rotaru Andrei**, Professor of University of Craiova, Department of Physics (Craiova); **Kapustin Alexey**, Professor of Pryazovskiy State Technical University, Department of Chemistry, Mariupol (Ukraine); **Kolosov Aleksandr**, Professor of National Technical University of Ukraine «Igor Sikorsky Kyiv Polytechnic Institute», Department of Chemical, Polymeric and Silicate Machine Building, Kyiv (Ukraine); **Krivenko Pavel**, Professor Kyiv National University of Construction and Architecture, Scientific Research Institute for Binders and Materials, Kyiv (Ukraine); **Martins Luisa**, Associate Professor of Universidade de Lisboa, Instituto Superior Tecnico, Lisbon (Portugal); **Plavan Viktoriia**, Professor Kyiv National University of Technologies and Design, Department of Applied Ecology, Technology of Polymers and Chemical Fiber, Kyiv (Ukraine); **Roshal Alexander**, V. N. Karazin Kharkiv National University, Research Institute of Chemistry, Kharkiv (Ukraine); **Rotaru Andrei**, University of Craiova, Department of Physics (Craiova); **Sprynskyy Myroslav**, Nicolaus Copernicus University in Torun, Department of Environmental Chemistry and Bioanalytics, Torun (Poland); **Sukhyy Mikhaylo**, Professor of Ukrainian State University of Chemical Technology, Department of Processing of Plastics and Photo-, Nano- and polygraphic materials, Dnipro (Ukraine); **Vakhula Yaroslav**, Professor of Lviv Polytechnic National University, Department of Silicate Engineering, Lviv (Ukraine); **Zeng Liang**, Tianjin University, School of Chemical Engineering and Technology, Tianjin (China)



## APPLIED MECHANICS

**Aifantis Elias**, Aristotle University of Thessaloniki, Thessaloniki (Greece); **Akhundov Vladimir**, Professor of National metallurgical academy of Ukraine, Department of Applied mechanics, Dnipro (Ukraine); **Andrianov Igor**, Professor of RWTH Aachen University, Department of General Mechanics, Aachen (Germany); **Astanin Vyacheslav**, Professor of National Aviation University, Department of Mechanics, Kyiv (Ukraine); **Avramov Konstantin**, Professor of A. Podgorny Institute of Mechanical Engineering Problems of the National Academy of Sciences of Ukraine, Department of reliability and dynamic strength, Kharkiv (Ukraine); **Fillimonikhin Gennadiy**, Professor of Central Ukrainian National Technical University, Department of Machine Parts and Applied Mechanics, Kropyvnytskyi (Ukraine); **Fomychov Petro**, Professor of National Aerospace University «Kharkiv Aviation Institute» named after N. E. Zhukovskiy, Department of Aircraft strength, Kharkiv (Ukraine); **Legeza Viktor**, Professor of National Technical University of Ukraine «Igor Sikorsky Kyiv Polytechnic Institute», Department of Computer Systems Software, Kyiv (Ukraine); **Lewis Roland W.**, Swansea University, Department of Civil Engineering, Swansea (United Kingdom); **Lvov Gennadiy**, Professor of National Technical University «Kharkiv Polytechnic Institute», Department of dynamics and strength of machines, Kharkiv (Ukraine); **Pukach Petro**, Professor of Lviv Polytechnic National University, Department of Computational Mathematics and Programming, Lviv (Ukraine); **Romualdovich Sergey**, Professor of National Aviation University, Department of Aircraft construction, Kyiv (Ukraine); **Sapountzakis Evangelos**, National Technical University of Athens, Civil Engineering, Athens (Greece); **Tornabene Francesco**, University of Bologna, Department DICAM, Bologna (Italy); **Uchino Kenji**, Pennsylvania State University, Electrical Engineering, University Park (USA); **Visser, Frank C.**, Flowserve, AMSS, Eindhoven (Netherlands); **Yaroshevich Nikolai**, Professor of Lutsk National Technical University, Department of Branch Engineering, Lutsk (Ukraine)

## ENERGY-SAVING TECHNOLOGIES AND EQUIPMENT

**Acaroglu Mustafa**, Selcuk Universitesi, Department Energy Division, Konya (Turkey); **Avramenko Andriy**, Professor of Institute of Engineering Thermophysics of National academy of sciences of Ukraine, Department of heat and mass transfer and hydrodynamics in heat power equipment, Kyiv (Ukraine); **Besagni Giorgio**, Ricerca sul Sistema Energetico, Energy Systems Development Department, Milan (Italy); **Calise Francesco**, Universita degli Studi di Napoli Federico II, Department of Industrial Engineering, Naples (Italy); **Fialko Nataliia**, Professor of Institute of Engineering Thermophysics of National academy of sciences of Ukraine, Department of energy efficient of heat technologies, Kyiv (Ukraine); **Guerrero Josep M.**, Aalborg Universitet, Energy Technology, Aalborg (Denmark); **Li Haiwen**, Kyushu University, Platform of Inter/Transdisciplinary Energy Research (Q-PIT), Fukuoka (Japan); **Liubarskyi Borys**, Professor of National Technical University «Kharkiv Polytechnic Institute», Department of electrical transport and diesel locomotive, Kharkiv (Ukraine); **Ma Zhenjun**, University of Wollongong, Sustainable Buildings Research Centre, Wollongong (Australia); **Morosuk Tatiana**, Technical University of Berlin, Institute for Energy Engineering, Berlin (Germany); **Popescu Mihaela**, University of Craiova, Department of Electromechanics, Environment and Applied Informatics, Craiova (Romania); **Rusanov Andrii**, Professor of A. Podgorny Institute of Mechanical Engineering Problems of the National Academy of Sciences of Ukraine, Department of Hydroaeromechanics of Power Machines, Kharkiv (Ukraine); **Santamouris Mattheos**, University of New South Wales, Built Environment, Sydney (Australia); **Sutikno Tole**, Professor of Universitas Ahmad Dahlan, Department of Electrical Engineering, Yogyakarta (Indonesia); **Tereshchenko Tatiana**, Professor of National Technical University of Ukraine «Kyiv Polytechnic Institute», Department of Industrial Electronics, Kyiv (Ukraine); **Yerokhov Valerij**, Professor of Lviv Polytechnic National University, Department of Semiconductor Electronics, Lviv (Ukraine)

## INFORMATION AND CONTROLLING SYSTEM

**Bezruk Valeriy**, Professor of Kharkiv National University of Radio Electronics, Department of Information and Network Engineering, Kharkiv (Ukraine); **Shcherbakova Galyna**, Associate professor of Odessa National Polytechnic University, Department of electronic apparatus & information technology, Odessa (Ukraine); **Uryvsky Leonid**, Professor of National Technical University of Ukraine «Igor Sikorsky Kyiv Polytechnic Institute», Department of telecommunication, Kyiv (Ukraine); **Sattarova Ulkar Eldar**, Associate Professor Azerbaijan University of Architecture and Construction, Department of Information technologies and systems, Baku (Azerbaijan); **Starovoitov Valery**, Professor, Doctor of sciences, United Institute of Informatics Problems, National Academy of Sciences of Belarus, Laboratory of System Identification, Minsk (Belarus); **Velychko Oleh**, Professor of State Enterprise «Ukrmettestandard», Institute of Electromagnetic Measurements, Kyiv (Ukraine); **Yatskiy Vasyly**, Associate professor of Ternopil National Economic University, Department of Cyber Security, Ternopil (Ukraine)

## ECOLOGY

**Boichenko Sergii**, Professor of National aviation universit, Department of ecology, Kyiv (Ukraine); **Gomelia Nikolai**, Professor of National Technical University of Ukraine «Igor Sikorsky Kyiv Polytechnic Institute», Department of Ecology and Technology of Plant Polymers, Kyiv (Ukraine); **Kisi Ozgur**, Iha State University, Faculty of Natural Sciences and Engineering, Tbilisi (Georgia); **Makarynskyy Oleg**, Australian Institute of Marine Science, Arafura Timor Research Facility (Australia); **Remez Natalya**, Professor of National Technical University of Ukraine «Igor Sikorsky Kyiv Polytechnic Institute», Department of Environmental Engineering, Kyiv (Ukraine); **Scholz Miklas**, Lunds Universitet, Department of Water Resources Engineering, Lund (Sweden); **Shvedchikova Iryna**, Professor Kyiv National University of Technologies and Design, Department of Electronics and Electrical Engineering, Kyiv (Ukraine)

## TECHNOLOGY AND EQUIPMENT OF FOOD PRODUCTION

**Adegoke Gabriel**, Professor of University of Ibadan, Department of Food Technology, Ibadan (Nigeria); **Barreca Davide**, Universita degli Studi di Messina, Department of Chemical Biological Pharmaceutical and Environmental Sciences, Messina (Italy); **Burdo Oleg**, Professor of Odessa National Academy of Food Technologies, Department of processes, equipment and energy management, Odesa (Ukraine); **Effat Baher**, National Research Centre, Dairy Science Department, Cairo (Egypt); **Erkmen Osman**, Gaziantep Universitesi, Department of Food Engineering, Gaziantep (Turkey); **Hafiz Ansar Rasul Suleria**, PhD, Kansas State University, Department of Food, Nutrition, Dietetics and Health, Manhattan (USA); **Modi Vinod**, Central Food Technological Research Institute India, Department of Meat, Fish and Poultry Technology, Mysore (India); **Pavlyuk Raisa**, Professor of Kharkiv State University of Food Technology and Trade, Department of Technology processing of fruits, vegetables and milk, Kharkiv (Ukraine)

## MATERIALS SCIENCE

**Apostolopoulos Charis**, Patras University, Department of Mechanical Engineering and Aeronautics, Patra (Greece); **Buketov Andriy**, Professor of Kherson State Maritime Academy, Department of Transport technologies, Kherson (Ukraine); **Dubok Vitalii**, Professor of Taras Shevchenko National University of Kyiv, Department of Radiophysical Phaculty, semiconductor physical chair, Kyiv (Ukraine); **Duriagina Zoia**, Professor of Lviv Polytechnic National University, Department of Applied Materials Science and Materials Engineering, Lviv (Ukraine); **Efremenko Vasily**, Professor of State Higher Educational Institution «Priazovskiy State Technical University», Department of Physics, Mariupol (Ukraine); **Gevorkyan Edvin**, Professor of Ukrainian State University of Railway Transport, Department of Quality, standardization, certification and materials making technology, Kharkiv (Ukraine); **Gubicza Jenő**, Eötvös Loránd University, Department of Materials Physics, Budapest (Hungary); **Gupta Manoj**, National University of Singapore, Singapore City (Singapore); **Sobol Oleg**, Professor of National Technical University «Kharkiv Polytechnic Institute», Department of Materials Science, Kharkiv (Ukraine); **Yaremiy Ivan**, Professor of Vasyly Stefaniuk Precarpathian National University, Department of Material Science and New Technology, Ivano-Frankivsk (Ukraine)

<p><b>Establishers</b> PC «TECHNOLOGY CENTER» Ukrainian State University of Railway Transport</p> <p><b>Publisher</b> PC «TECHNOLOGY CENTER»</p> <p><b>Editorial office's and publisher's address:</b> Shatilova dacha str., 4, Kharkiv, Ukraine, 61145</p> <p><b>Contact information</b> Tel.: +38 (057) 750-89-90 E-mail: cejet.kh@gmail.com Website: <a href="http://www.jet.com.ua">http://www.jet.com.ua</a>, <a href="http://journals.urau.ua/cejet">http://journals.urau.ua/cejet</a></p> 	<p><b>Journal Indexing</b></p> <ul style="list-style-type: none"> <li>■ Scopus</li> <li>■ CrossRef</li> <li>■ American Chemical Society</li> <li>■ EBSCO</li> <li>■ Index Copernicus</li> <li>■ Российский индекс научного цитирования (РИНЦ)</li> <li>■ Ulrich's Periodicals Directory</li> <li>■ DRIVER</li> <li>■ Bielefeld Academic Search Engine (BASE)</li> <li>■ WorldCat</li> <li>■ Electronic Journals Library</li> <li>■ DOAJ</li> <li>■ ResearchBib</li> <li>■ Polska Bibliografia Naukowa</li> <li>■ Directory of Research Journals Indexing</li> <li>■ Directory Indexing of International Research Journals</li> <li>■ Open Academic Journals Index</li> <li>■ Sierpa/Romeo</li> </ul>	<p><b>Свідоцтво про державну реєстрацію журналу</b> КВ № 21546-1446 ПП від 08.09.2015</p> <p><b>Атестовано</b> Вищою Атестаційною Комісією України Перелік № 12 постанови Президії ВАК № 1-05.36 від 11.06.03</p> <p>Постановою Президії ВАК України № 1-05/2 від 27.05.2009, № 1-05/3 від 08.07.2009 Бюлетень ВАК України</p> <p>Наказом Міністерства освіти і науки України №793 від 04.07.2014</p> <p><b>Підписано до друку</b> 31.01.2019 р.</p> <p>Формат 60 × 84 1/8. Ум.-друк. арк. 10,5. Обл.-вид. арк. 9,77 Тираж 1000 экз.</p>
--	--	--



22. Enhanced public key security for the McEliece cryptosystem / Baldi M., Bianchi M., Chiaraluce F., Rosenthal J., Schipani D. // arXiv.org. URL: <https://arxiv.org/abs/1108.2462>
23. Yevseiev S., Rzayev Kh., Tsyhanenko A. Analysis of the software implementation of the direct and inverse transform in non-binary equilibrium coding method // Journal of Information Security. 2016. Vol. 22, Issue 2. P. 196–203.
24. Niederreiter H. Knapsack-type cryptosystems and algebraic coding theory // Problems of Control and Information Theory. 1986. Vol. 15, Issue 2. P. 159–166.
25. Mishchenko V. A., Vilanskiy Yu. V. Ushcherbnye teksty i mnogokanal'naya kriptografiya. Minsk: Enciklopediks, 2007. 292 p.
26. Mishchenko V. A., Vilanskiy Yu. V., Lepin V. V. Kriptograficheskii algoritm MV 2. Minsk, 2006. 177 p.
27. A statistical test suite for random and pseudorandom number generators for cryptographic applications / Rukhin A., Sota J., Nechvatal J., Smid M., Barker E., Leigh S. et. al. // NIST. 2000. doi: <https://doi.org/10.6028/nist.sp.800-22>
28. Berlekemp E. R. Algebraicheskaia teoriya kodirovaniya. Moscow: Mir, 1971. 480 p.
29. Teoriya kodirovaniya / Kasami T., Tokura N., Iwadari E., Inagaki Ya. Moscow: Mir, 1978. 576 p.
30. Kuznecov A. A., Korolev R. V., Tomashevskiy B. P. Ocenka stoykosti kriptokodovykh sredstv zashchity informacii k atakam zlomyshlennika // Systemy upravlinnia, navihatsii ta zviazku. 2010. Issue 2 (14). P. 114–117.
31. Naumenko N. I., Stasev Yu. V., Kuznetsov O. O. Teoretychni osnovy ta metody pobudovy alhebraichnykh blokovykh kodiv. Kharkiv: KhUPS, 2005. 267 p.
32. Yevseiev S. P., Ostapov S., Bilodid I. Research of the properties of hybrid crypto-code constructions // Ukrainian Information Security Research Journal. 2017. Vol. 19, Issue 4. P. 278–290. doi: <https://doi.org/10.18372/2410-7840.19.12206>

*На основі аналізу систем технічної діагностики проведено дослідження силових впливів, що виникають в технологічних комплексах. У зв'язку з поділом силових впливів на детерміновані та випадкові, запропоновано різні способи виділення вібрації інформаційних діагностичних характеристик для забезпечення оперативного і достовірного виявлення дефектів, які швидко розвиваються. Достовірна діагностика дозволить перейти з системи планово-попереджувальних ремонтів на організацію ремонтів по поточному стану і зниженню витрат на ремонт і відновлення вузлів технологічних комплексів шляхом раннього виявлення дефектів, що зароджуються у вузлах.*

*Проаналізувавши процес поширення віброакустичних хвиль, зумовлених силовим впливом, створено математичну модель виникнення та поширення пружних хвиль в складних технологічних комплексах від місць їх виникнення до точки спостереження. Наведено кінематичні схеми розповсюдження низькочастотних вібрацій, вібросигналів від щітково-колекторного вузла, а також хвилі від внутрішнього кільця підшипника. Це дало змогу обґрунтувати математичну модель виникнення та поширення віброакустичних хвиль в деталях і вузлах складних технологічних комплексів від різних джерел вібрації.*

*За результатами порівняльного аналізу результатів дослідження реальних вібраційних полів та результатів чисельного моделювання підтверджено адекватність моделі і реального процесу. Наведено графіки часової реалізації сигналів у моделі, спектри реалізованих сигналів, а також їх автокореляційні функції, що відображають основні характеристики сигналів в точці вимірювання. Отримані результати можуть бути використані для технічної діагностики та щодо зниження витрат на ремонт і відновлення вузлів складних технологічних комплексів шляхом раннього виявлення дефектів, що зароджуються у вузлах*

*Ключові слова: вібросигнал, стохастичний, підшипники кочення, поля вібрації, віброакустичні хвилі, ударні імпульси*

UDC 004.94:681.2:621.3

DOI: 10.15587/1729-4061.2019.155839

## THE DEVELOPMENT OF METHODS FOR DETERMINING VIBRATION STOCHASTIC FIELDS OF TECHNOLOGICAL COMPLEXES

**N. Marchenko**

PhD, Associate Professor

Department of

Computerized Control Systems\*

**O. Monchenko**

PhD, Associate Professor

Department of

Biocibernetics and Aerospace Medicine\*

E-mail: [monchenko\\_olena@ukr.net](mailto:monchenko_olena@ukr.net)

**G. Martyniuk**

PhD

Department of

Information-Measurement Systems\*

\*National Aviation University

Kosmonavta Komarova ave., 1, Kyiv,

Ukraine, 03058

### 1. Introduction

Nowadays, in general, more and more attention is paid to the technical diagnostics of sophisticated technological complexes (TCs) in operation and to the prognoses of their

further performance. To a large extent, this is due to the role of technical diagnostics in reducing the cost of repair and restoration of TC units by early detection of defects that originate in the assembly parts. Only reliable diagnostics can allow the transition from the system of planned

and preventive maintenance to the organization of repairs according to the current state. At present, the increase in the cost of new spare parts, on the one hand, and the requirements to reduce operating costs, on the other hand, while maintaining the level of reliability and safety [1], necessitates the improvement of the system and, in some cases, create new information technologies for diagnostics and repair.

The paper considers the existing methods of operational control of the performance of rolling bearings of various TCs. The characteristic damage of bearing units of high-power TCs is analyzed in terms of the probability of sudden failure of the support and the possibility of early detection of damage by known methods [2].

One of the main sources of the vibration waves in a rotating electric machine is the operation of its active zone, i. e. elements adjacent to the working air gap between the rotor and stator magnetic circuits. This is explained by the fact that in the active zone of an electric machine there are force interactions between magnetic fields and conductors, which is the basis of transformation of electromagnetic forms of energy into mechanical and vice versa. The spectral composition of electromagnetic vibrations is limited in the range of high frequencies by the speed of mutual displacements of magnetic fields and conductors, as well as by the maximum gradients of the electromagnetic fields of the machine in the tangential direction. And, as the study shows, the maximum energy of electromagnetic vibrations falls at a frequency of 10–50 Hz and has an effective spectrum width of 100–500 Hz [3].

Vibrations caused by the unbalance of the rotary part are of great importance for high-speed machines when operating in the domain of maximum speeds [1, 4]. In this case, the first harmonic of the spectrum of the vibratory forces is precisely determined by the speed of rotation of the rotor, and the spectral component is in the frequency range of vibrations of TC electromagnetic interactions.

For large DC technological complexes, for example, traction locomotives, a significant role in the general picture of the vibration fields, especially in the frequency range above 1 kHz, is played by the acoustic waves generated by the brush-collector unit's operation. Depending on the reason, the period of vibration signals in this case may have different degrees of correlation with the speed of rotation of the armature machine.

Rolling bearings are the main sources of vibration of electric machines, especially in the frequency range of more than 1 kHz. The stochastic vibration signals that are associated with the rolling bearing operation can be subdivided into two large groups. The first group is connected with the unessential geometry of the parts, for example, the wavelength of the rolling paths. Damage in the second group is caused by local damage to the working surfaces, for example, fatigue cracks. The vibration parameters caused by the second group of causes, on the contrary, have a significant spread, both in terms of the repetition period and amplitude. This is due to the large number of degrees of freedom for mutual displacement of bearing parts. It can be argued that in the performance of the rolling bearing with local damage to the working surfaces, there must be force interaction in the form of shock impulses, the amplitude and the period of repetition of a random nature.

---

## 2. Literature review and problem statement

---

In [4], traction electric machines are characterized by damage to the working surfaces of rolling bearings. Their location is shown in order of the increasing probability of instantaneous loss of the host's performance.

Exfoliation means small (with a diameter of less than 0.1 mm) fatigue shells. Damage arises at the beginning on the most loaded areas of the rings (for example, in the lower zone of the outer clasp) and rollers, and then it develops on other working surfaces of the component parts. This damage, as a rule, does not result in the loss of the capacity of the unit and is detected during major repairs to TCs.

Burns are local thermal damage that occurs when a significant electric current passes through the bearing. This is characteristic of electric locomotives.

Overriving is the emergence of local damages in the form of the entry of rollers to the surface of the rings in the process of transporting the machine. In the case of a significant damage, it can lead to cracks.

Fatigue shells and chipped sides are shells with a diameter larger than 0.5 mm. The result is the rupture of rings or destruction of roller bodies and loss of the bearing capacity.

Cracks arise when the setting of rings in the bearing is violated, which results in the rupture of rings and disability.

Thus, the task of diagnosing the bearings of electric motors is to promptly detect local damage, for example, type 2 and type 3, not allowing their further development. But the authors of the work left unresolved the problem of reliability.

One of the directions to solve this problem is the use of complex diagnostic systems, which allow to determine with high probability the current state of assembly units and parts of the rolling stock by the set of diagnostic signals [5]. The basis of such systems is a PC with an appropriate software that would allow you to determine the parameters of the diagnostic signals, as well as store the resulting values in the form of a data bank for each unit of the operated fleet. By analyzing the change of parameters from one cycle of diagnostics to another and comparing with the maximum allowable values it is possible to observe the change in the technical state of the units and parts and also to predict their efficiency and reliability [6]. The use of such systems will significantly reduce the volume of repair and restoration work, as well as increase the reliability of the rolling stock. In general, it can reduce the economic costs associated with the rolling stock fleet maintenance. But a wide introduction into the operational practice of such systems is constrained by a number of reasons. This is primarily a significant cost for the development and production of a comprehensive diagnostic system, as well as the lack of highly skilled specialists for their service.

Small-scale portable means of technical control may become an option to overcome the corresponding difficulties. Means and devices of this class are not expensive; they do not require changes in the adopted control system and repair technology, but require special training of the service personnel [7]. At the same time, such devices can serve to collect preliminary information about diagnostic signals and how to obtain and process them, which is necessary for the development of integrated systems.

When rolling bearings are tested on special stands, the resistance of the electric current of the oil film between the moving and non-moving parts of the bearing is



frequently used as a diagnostic parameter [8]. The measurement of this parameter allows us to assess the current state of the working surfaces of the assembly parts and determine the residual motor resource. The size of the electrical resistance practically does not affect the smooth irregularities of the working surfaces, i. e. this parameter has a high selectivity as for the local, most dangerous, damage. But the resistance of the oil wedge is determined primarily by the quality and condition of the lubricant itself. Consequently, this method of diagnostics is not applied to the used bearing units, especially when grease lubricants are used.

The methods of checking the performance of rolling bearings by the unit temperature [9] or by the speed of the separator [8], which are used in various branches of engineering, allow us to monitor their performance at the time of inspection. This is the approach used in [9], but it is not possible to reliably estimate the residual lifetime of an object using these diagnostic parameters.

There is known a large number of methods for the diagnosis of various mechanisms that is based on the measurement of the parameters of stochastic processes accompanying the operation [10]. The choice of acoustic waves as a source of information is due to the fact that the vibrational waves created by working under the load bearing are directly associated with the force interaction between its parts. Consequently, any change in the nature of the contact between the bearing parts, such as changing the geometry or the lubrication mode, will cause a change in the pattern of the vibration field. An intense change in the geometry of the bearing parts, plastic deformation or crack opening necessarily give rise to the appearance of elastic waves in the material of the elastic stress waves of a wide frequency spectrum. This is reflected in the picture of vibration of the machine surface at the point of the possible observation [1].

The use of spectral analysis of vibration for the diagnostics of rotating parts is based on the natural periodicity of the change in mechanical loads, which causes periodic changes in the pattern of vibroacoustic waves of the working mechanism. The existing and currently available portable spectroanalyzers allow analyzing the vibration processes that occur in working mechanisms, with subsequent transfer of information to the PC. The obtained results are compared with those available in the databank and the results of the preliminary measurement. All this suggests that it is expedient to study the diagnostic methods that determine the location and nature of the damage, trace the dynamics and make forecasts for its development.

---

### 3. The aim and objectives of the study

---

The aim of this work is to study the vibroacoustic fields of dynamic electric machines and to develop methods for distinguishing in the general vibration picture the diagnostic parameters that provide operative and reliable detection of rapidly developing defects.

To achieve this aim, the following objectives were set:

- to develop and implement a mathematical model of the occurrence and spread of vibroacoustic waves in a working electric machine from their places of origin to the point of observation;

- to compare the results of the study of the real vibration fields in a working electric machine with the results obtained during numerical simulation;

- to draw a conclusion on the adequacy of the proposed model to real processes.

---

## 4. Investigation of vibroacoustic fields in electric machines

---

### 4.1. The modelling of input effects

Let us analyze the system of technical diagnostics [4]. The object of the diagnosis is characterized by a set of time-dependent parameters of the state  $Z_i(t)$ ,  $i=1, 2, 3, \dots, n$ . The operation of the object is accompanied by the appearance of secondary processes, whose parameters  $Y_j$ ,  $j=1, 2, \dots, m$  (diagnostic parameters) are related to  $Z_i(t)$  with some dependence:

$$Z_i(t) = f(Y_1, Y_2, Y_3, \dots, Y_m). \tag{1}$$

Parameters  $Y_j$  are to be directly dimensioned without disassembling or destroying an object, and their set must uniquely determine the parameters of the state  $Z_i(t)$

The information thus obtained can be used to reject objects (according to the principle of “applicable – not applicable”) or to predict the technical condition. For example, having determined (based on the statistics of operation) the limit value of the diagnostic parameter  $Y_{max}$ , which corresponds to the moment of failure of the object being diagnosed. Also, knowing the current values of  $Y_j(t_1)$  and  $Y_j(t_2)$  obtained at the moments of time  $t_1$  and  $t_2$ , it is possible to use the linear extrapolation to determine the residual lifetime of the object before its failure:

$$T = (Y_{max} - Y_j(t_2)) \cdot \left( \frac{t_2 - t_1}{Y_j(t_2) - Y_j(t_1)} \right). \tag{2}$$

The connection between the parameters of the state  $Z_i(t)$  and the diagnostic parameters can be both functional and probabilistic. Moreover, in the latter case, an increased number of diagnostic parameters at their rational choice raises the probability of diagnosis.

For any system of distribution and transmission of energy, the change in the output values  $X_i$ , for a multidimensional system, is determined by the values of the input effects  $F_i$  and the transmission characteristics of the system  $Q_{ij}$  through the Duamel integral [1]:

$$\begin{bmatrix} X_1(t) \\ X_2(t) \\ \dots \\ X_i(t) \end{bmatrix} = \int_{-\infty}^{\infty} \begin{bmatrix} Q_{11}(t-\tau) & Q_{12}(t-\tau) \dots Q_{1j}(t-\tau) \\ Q_{21}(t-\tau) & Q_{22}(t-\tau) \dots Q_{2j}(t-\tau) \\ \dots & \dots \\ Q_{i1}(t-\tau) & Q_{i2}(t-\tau) \dots Q_{ij}(t-\tau) \end{bmatrix} \times \begin{bmatrix} F_1(\tau) \\ F_2(\tau) \\ \dots \\ F_j(\tau) \end{bmatrix} d\tau, \tag{3}$$

where  $X_i(t)$  is the  $i$ -th output value;  $F_j=f(t)$  are input actions;  $Q_{ij}$  is the impulse transfer function of the system for the response  $X_i$  from the influence of  $F_j$ .



We shall consider the value of vibration acceleration at the point of the sensor installation as the desired output feedback  $X_i$ . The size of the vector of input effects  $F$  is determined by the number of independent inputs, both in terms of time implementation of processes and the point of origin. The elements of the matrix  $Q$  due to the nonlinearity of the system in general depend on the values of the input effects  $F$ , but for most of the low-energy effects the nonlinearity can be neglected. This assumption is valid if the value of the vibration displacement from the  $j$ -th effect is small as to the deformation of the parts under the action of static loads. The above described is applicable primarily to the impulse response. In this case, the parametric effects on the impulse transfer function  $Q_{ij}$  are not excluded. Thus, in the modeling system, the principle of superposition is performed for the propagation of shock-driven vibration signals and is not applied to low-frequency effects.

By setting the domain of admissible values of the input effects  $F_j$  and determining the elements of the array of transfer functions  $Q$ , we obtain a mathematical model of the formation of the dynamic TC vibration field. The model is suitable for further investigations of changes in the parameters of the initial response  $X_i=f(t)$  [11].

To construct the model, we divide all the force effects arising in the TC into deterministic and random. The deterministic force effects primarily include the forces arising in the magnetic zone of the machine and the vibrations of the rolling bearings associated with the deviations in the shape of the bearing parts from the ideal. They have significant power, but in a very limited range of frequencies.

The sources of force effects of this group are proposed to be considered as polyharmonic effects:

$$F_{\text{sin}}(t) = \sum_{k=1}^n F_k \sin\left(\frac{2\pi}{T_k} t + \phi_k\right), \quad (4)$$

where  $F_{\text{sin}}(t)$  is temporal realization of the force effect;  $F_k$  is the amplitude of the force effect from the  $k$ -th factor;  $T_k$  and  $\phi_k$  are, respectively, the repetition period and the initial phase of the  $k$ -th power wave.

It should be noted that, in spite of the almost rigid deterministic dependence of the frequency of each individual wave on the period of the force variation, the values of  $T_k$  and  $\phi_k$  do not correlate, which is explained by their different physical nature. For example, the frequencies of magnetic pulsations are determined by the frequency of the power supply and the frequencies of the local vibrations of the magnetic field from the interactions of the gear zones of the machine. For asynchronous machines, these values can be correlated because of the amount of slip, but the latter depends on the moment of rotation of the machine shaft and is not set in our task [3]. For machines with direct current, the rotation speed theoretically does not depend on the frequency of the supply voltage pulsations. Then in the form of polyharmonic influence in the model it is necessary to consider a small number of sources of low-frequency vibrations with the highest energy. These include an unbalance of the rotating part, the first harmonic of the power supply frequency and the vibration from non-ideal bearing rings (assembly deformations of the rings). Meantime, the ways of occurrence of low-frequency waves are considered as random waves with a normal distribution of amplitudes and a limited spectrum. Then equation (4) will take the following form [1]:

$$F_{\text{sin}}(t) = \sum F_{nk} \sin\left(2\pi \frac{kn}{60} t + \phi_k\right) + \sum F_{lk} \sin(2\pi k f_{\text{network}} t + \phi_k), \quad (5)$$

where  $0 < k \leq 10$ ,  $F_{nk}$  is the amplitude of the force effect from the  $k$ -th factor associated with the speed of the machine shaft;  $F_{lk}$  is the amplitude of the force effect of the  $k$ -th factor associated with the frequency of the power supply.

In the second group of deterministic force effects there are included fast-change processes that accompany the work of the brush-collector unit of DC machines: the co-brush of the machine with collector plates and the sparking of the brushes. In both cases, there occur pulse actions, the repetition period of which is determined by the speed of rotation and the number of collector plates, and the duration of exposure is too short compared to the period of repetition. Then, the interaction data can be represented as follows:

$$F_\gamma(t_i) = \begin{cases} 0; & t_i \neq t + \frac{60}{nK}, \\ \sigma(t_i); & t_i = t + \frac{60}{nK}, \end{cases} \quad (6)$$

$$F_\gamma(A) = \int_{-\infty}^{\infty} \sigma(t) \delta t,$$

where  $F_\gamma(t)$  is the time realization of the force impulse;  $F_\gamma(A)$  is the amplitude of the force impulse;  $60/nK$  is the period of repetition of force impulses.

A large number of other low-frequency sources of force effects and the absence of functional and correlation interactions between them allow to represent them as a frequency-limited random process by the Gaussian distribution law [12]:

$$P(F_\Sigma) = \frac{1}{\sqrt{2\pi\sigma}} \exp\left[-\frac{(A-m)^2}{2\sigma^2}\right], \quad (7)$$

where  $P(F_\Sigma)$  is the probability of the force impulse  $F_\Sigma$  with amplitude  $A$ ;  $m$ ,  $\sigma$  are respectively the mathematical expectation, the magnitude variance, and the mean square deviation  $F_\Sigma$ .

The correlation corresponds to the time realization of the process as [3]:

$$F_\Sigma(t) = U(t) \text{Cos}(\omega_0 t + \phi(t)), \quad (8)$$

where  $U(t)$  is the power wave envelope;  $\omega_0$  is the central frequency of the spectrum;  $\phi(t)$  is the initial phase of quasi-fluctuations.

The variable of  $U(t)$  is a random function distributed by the Relay law for which the dispersion value corresponds to the dispersion of the value  $P(F)$ :

$$P(U) = \frac{U}{\sigma^2} \exp\left(-\frac{U^2}{2\sigma^2}\right). \quad (9)$$

The initial phase  $\phi(t)$  has an even distribution within an interval from 0 to  $2\pi$ :

$$P(\phi) = \frac{1}{2\pi}. \quad (10)$$

Shock force effects that occur while passing the local defects of the working surfaces of the bearing parts in the load



zone. This happens due to the short interaction with respect to the average period of repetition similar to (6):

$$F_d(t_i) = \begin{cases} 0; & t_i \neq t + nT_k, \\ \sigma(t_i); & t_i = t + nT_k, \end{cases} \quad (11)$$

$$F_d(A) = \int_{-\infty}^{\infty} \sigma(t) \delta t,$$

where  $F_d(t)$  is the time of the force impulse;  $F_d(A)$  is the amplitude of the force impulse;  $T_k$  is periodicity of repetition of the force impulses.

Moreover, the values of  $F_d(A)$  and  $T_k$ , as shown earlier, are random and follow the normal distribution law because of the large number of degrees of freedom.

**4. 2. Modelling of the propagation of vibroacoustic waves**

Based on the analysis of the propagation of vibroacoustic waves (which result from the influence of  $F_i$  in the structure of the machine), from the point of their origin to the measuring point, we suppose the form of vibration acceleration of the surface  $X$  [12]. It is proposed to present the transmission channel as a complex system consisting of masses of separate sections  $m_{ij}$ , elements of elastic connections  $C_{ij}$ , and elements of absorption of energy from the wave  $Y_{ij}$ . The kinematic scheme of propagation of power waves in the proposed system is shown in Fig. 1:

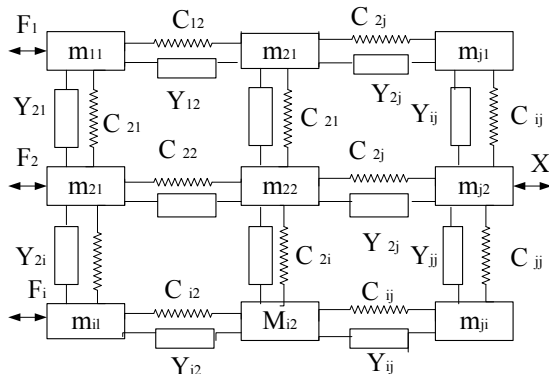

Fig. 1. A kinematic scheme of propagation of power waves

If we consider the propagation of low-frequency vibrations (magnetic noise, vibration of the not-ideal bearing, etc.), then, the elements of the machine's body such as resonances of individual elements of the machine (for example, internal and external bearing rings) and resonances of the machine body serve as separate vibrational contours of the presented system. At the same time, the length of the generated wave of vibration significantly exceeds the dimensions of the machine. Thus, the frequency of forced vibrations of 500 Hz corresponds to the length of the longitudinal wave in the steel of about 6 meters [6]. Consequently, the distribution channel for this type of effects can be presented as a kinematic scheme (Fig. 2).

In this case,  $F_{sin}(t)$  and  $F_{\Sigma}(t)$  determined in equations (5) and (8) are accepted as input effects  $F_i$ .

Forced vibrations of this system can be described by the differential equation of the  $n$ -th order [6]:

$$\sum_{i=0}^n a_i \frac{\partial^i X}{\partial t^i} = \sum_{i=0}^m b_i \frac{\partial^i (F_{sin}(t) + F_{\Sigma}(t))}{\partial t^i}. \quad (12)$$

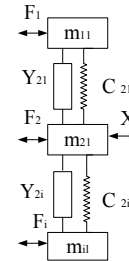

Fig. 2. A kinematic scheme for the propagation of low-frequency vibrations

The impulse transfer function, expressed in terms of complex frequency transmission coefficients, looks in the following way [13]:

$$Q(t) = \frac{1}{2\pi} \int_{-\infty}^{\infty} K(j\omega) \exp(j\omega) \delta\omega, \quad (13)$$

where  $K(j\omega)$  is the frequency transfer coefficient.

The transition to considering the behavior of the system from the time domain to the frequency domain is explained by the fact that the frequency transfer coefficient  $K(j\omega)$  can be determined directly from equation (12) without resorting to the solution of the differential equation [12]:

$$K(j\omega) = \frac{\sum_{i=0}^n b_i(j\omega)^i}{\sum_{i=0}^m a_i(j\omega)^i}. \quad (14)$$

Similarly, the frequency transfer coefficient can be determined experimentally by the spectral component of vibration signals under the influence of a random input signal by approximating spectrographs in the form of polynomials of the  $k$ -th order [13].

For high-frequency vibrations, the length of the acoustic wave in the steel is  $10^{-1}-10^{-2}$  m and is commensurable with the dimensions of the machine parts. Here vibration systems are represented by the waves from the heterogeneities in the elements of the machine parts that arise when reflecting the front. The source of high-frequency excitations in electric machines, according to equations (6) and (11), is the work of the brush-collector unit and the bearing. In the first case, the force acts directly on the body parts, rigidly fixed relative to each other, i. e. the efforts of the previous strain in the mounting units by far exceed the possible dynamic effort from the loads. Then one can neglect non-linear cross-links with other sources of power waves, which corresponds to the kinematic scheme shown in Fig. 3 [13].

The impulse transfer function of the channel typical of the perturbation  $F_b$  according to equation (14) is found based on the experimentally determined amplitude-frequency characteristic of the transmission channel.

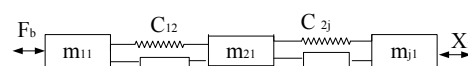

Fig. 3. A kinematic scheme of propagation of vibration signals from the brush-collector unit

Shock effects from local defects of the working surfaces of the rolling bearings  $F_d$  occur in two equally probable points of origin: in the collision between the inner ring and the vibration body or the outer clamp and the rolling body.



The propagation of the elastic wave from the outer clasp occurs in a similar way to the propagation of  $F$ . In the case of the wave propagation from the inner ring, the transfer of energy from the rolling body to the outer edge occurs through the contact zone, the area of which is determined by the instantaneous load on this body. Consequently, in this case it is necessary to take into account the effect of low-frequency vibrations on the process of the wave transmission [11]. The kinematic scheme of the propagation channel for this case is shown in Fig. 4.

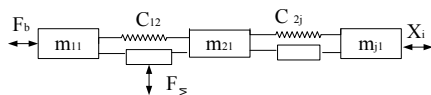

Fig. 4. A kinematic scheme of propagation of the wave from the inner bearing ring

Accordingly, the impulse transfer function of the channel is represented as [13].

$$Q(t) = \frac{1}{2\pi} \int_{-\infty}^{\infty} f(F_z(j\omega))K(j\omega)\exp(j\omega)t d\omega, \quad (15)$$

where  $f(F_z(j\omega))$  is the nonlinearity of the transmission characteristic.

#### 4. 3. A research on of vibroacoustic signals from the operation of TCs with defective bearings

To verify the theoretical preconditions for the nature of the vibroacoustic fields of electromechanical converters, we have thoroughly studied their vibroactivity depending on the mode of operation and the technical conditions. The main objects of research were traction electric motors of locomotives ED-118 and electric locomotives NB-418, i. e. collector machines of successive excitation with a capacity of 300–790 kW. By their construction, electric motors are classic DC motors. Bearing supports of the engine NB-418 are made on roller bearings No. 42330. The engine ED-118 has got roller bearing No. 42330 inset from the side of the shaft outlet, and roller bearing No. 92417 – on the opposite side. The use of roller bearings in the supports provides free axial movement of the anchor machine within the range of 1–3 mm, which is limited by the ends of the roller clamp in one of the inner rings. Such a design of the axial line of the TC serves to equalize loads in gearsets while operating the engine and eliminates the thermal impact of the anchor shaft on the operation of the unit.

In the research, electric motors were installed on wooden substrates on a rigid base in a horizontal position and were rotated in idle mode. Power was supplied from an adjustable single-phase transformer. The speed of rotation varied from zero to the maximum change in the voltage. Labyrinth seals of bearing units for engines NB-418 and areas of bearing shields adjacent to bearing units for engines ED-118 were chosen as places to install vibration sensors in.

To successfully solve the practical tasks of vibration acoustic diagnostics of the rolling bearings, one must know the degree of mutual influence of the bearings on the parameters of the vibration field at the measuring point. The given task can be solved by determining the values of the coefficients of attenuation of vibration acoustic waves in the body of the machine at different frequencies. The study of the attenuation of waves in the body of the machine was carried

out by perturbing the acoustic pulses in the machine and further measuring the relative levels of the spectral density of the vibration acceleration [2].

We carried out the research on real objects and measured the parameters of vibration signals that arise when TC with defective bearing supports is operated.

The bearing diagnostics device PDD-SM manufactured by the SC “Vibrotehnika” (Lithuania) was used as a primary measuring instrument. Characteristics of the vibration signal were measured and recorded with the help of the oscilloscope S8-17; the vibration signal envelope was recorded by means of a magnetoscope.

The PDD-SM is intended for continuous control over the operation of TC ball-bearing units by measuring the average and peak levels of vibration acceleration of the body in the band of 10–50 kHz. A complete piezoelectric accelerometer served as a primary converter in the device operating at a frequency of 26 kHz and having an effective bandwidth of 5 kHz.

The change in the frequency range of the investigated vibroacoustic signals is due to the desire to increase the ratio between the signal from the defect and the obstacles from the work of the brush-collector node. Since the task of measuring the spectral composition of vibration signals was not raised, the application of the resonant converter does not introduce additional distortions in the observed pattern. Simultaneously with the measurement of the signal levels, we observed the shape of the vibration signal and made its magnetic recording.

The most labor-intensive part of the work at this stage was distinguishing units that have various dangerous damage to the working surfaces of rolling bearings from the general exploited TC fleet. The results of organoleptic control of the performance of anchor bearings were used as a criterion of selection. After measuring the vibroactivity, TC nodes were repaired in accordance with the adopted technological program. After dismantling, rolling bearings were subjected to complete disassembly and magnetic defectoscopy. Investigation of TC high-frequency vibration signals in the time domain confirmed that in the case of a healthy bearing, vibration is a stationary ergodic random process, if the observation time significantly exceeds the period of one revolution of the machine shaft [3].

In this case, there may be isolated random acoustic impulses that exceed the average amplitude of the signal envelope by 1–2 orders of magnitude. One of the reasons for the increased probability of this process may be the external solid inclusions in the lubricant, then the average frequency of vibroacoustic pulses can reach 10–50 signals per minute at a pulse duration of  $10^{-4}$  seconds.

In the case of local violations in the shape of the working surfaces of the bearing, his work is accompanied by the appearance of shock impulses uncorrelated over the repetition period and amplitude [2].

As the defect develops, the ratio of the average amplitude of the acoustic impulse to the mathematical expectation of the signal envelope increases. At the same time there is observed a transition of shock impulses from the random to the quasideterministic process.

As a result of experimental studies of the characteristics of vibroacoustic signals using the PDD-SM device, a conclusion was made regarding the following. The ratio of the amplitude of the vibration signal to the average (peak factor) for normal bearings is 3–6, the appearance of local



damage or random shock impulses is accompanied by a sharp increase in the peak factor up to 50, and further development of the defect leads to its decrease to 5–8 [2]. Fatigue failure, such as exfoliation, increases the average value by 10–30 dB, without practically changing the peak factor.

## 5. The results of numerical simulation and checking the adequacy of the model to real processes

### 5.1. Software for simulating the fields of vibration

After determining the perturbing forces  $F(t)$  and impulse transfer functions of the system  $Q(t)$  from each source of vibrations, it is possible to determine the time realizations of the initial values (for example, the acceleration of the surface at the measuring point). In equation (1), for one observation point and assumed assumptions, the matrix  $F(t)$  has a dimension of  $1 \times 4$ . The matrix  $Q(t)$  also contains, respectively, four elements representing indeterminate integrals from the frequency characteristics obtained in the experiment in accordance with (11):

$$[X_1(t)] = \int_{-\infty}^{\infty} \begin{pmatrix} Q_1(t-\tau) \\ Q_2(t-\tau) \\ Q_3(t-\tau) \\ Q_4(t-\tau) \end{pmatrix} \times \begin{pmatrix} F_{\sin}(t) & F_{\Sigma}(t) & F_b(t) & F_d(t) \end{pmatrix} d\tau. \quad (16)$$

The solution of equation (16) in general is divided into a set of partial solutions due to the interconnection of the initial conditions. This does not allow analyzing the interconnection of the characteristics of the output value of  $X_1(t)$  with the change in the parameters of the input force  $F_d(t)$  and the propagation conditions. However, solution to this problem is possible by numerical methods, for example, by simulating the process with the use of a PC [14]. When choosing a programming system you have to take into account the following requirements:

- the need to implement various types of input effects;
- the possibility to create systems of transformation of input effects taking into account their internal mutual influence;
- the ability to set conversion parameters through the frequency characteristics of the system elements;
- providing flexibility in changing the parameters, both input effects and transformation characteristics;
- the possibility of further processing of the results.

The systems for simulation of similar electrical circuits and systems most fully satisfy the set conditions. So, in electrical systems there is a developed method for creating various input effects with the help of generators of special signals (sinusoidal, pulsed, and random). The impulse transfer functions were determined according to the frequency characteristics given in different forms. We have designed a large number of measuring devices for the study of time, frequency and statistical characteristics of output signals.

The existence of analogies between mechanical and electrical systems is based on the formal similarity of differential equations describing the behavior of these systems. Thus, when the mechanical force  $F(t)$  is replaced by the electric voltage  $U(t)$ , the coordinate of the point  $X(t)$  is represented by the charge value  $q(t)$ . Then we get a system of formal substitution of physical variables:

$$F(t) \equiv U(t); \quad X(t) \equiv q(t);$$

$$\frac{\partial X(t)}{\partial t} = v(t) \equiv \frac{\partial q(t)}{\partial t} = I(t); \quad \frac{\partial^2 X(t)}{\partial t^2} = a(t) \equiv \frac{\partial I(t)}{\partial t};$$

$$m = \frac{F(t)}{a(t)}; \quad L \equiv \frac{U(t)}{\partial I(t)} \partial t; \quad C = \frac{F(t)}{X(t)} = \frac{U(t)}{q(t)}, \quad (17)$$

where  $I(t)$  is the value of the electric current;  $L$  is inductance;  $C$  is electric capacity;  $R$  is the resistance of the chain.

This replacement makes it easy to carry out the transition from the mechanical forces in expression (16) to the parameters of electrical signals, kinematic schemes in Fig. 2–4 to electrical circuits and vice versa.

There are various software products for simulating electrical circuits of any complexity, for example, widely known Workbench, Circsolv and MicroCap of various versions. These software products allow building computer models of electric circuits (consisting both of passive elements such as resistors, capacitors, inductors, and active components like transistors, as well as analog and digital chips). They also allow analyzing the operation of the circuit in the steady-state or transient modes with different input effects, as well as investigating its frequency and time characteristics [15].

But the listed programs require excessive details of the scheme, so when constructing an electric filter, it is necessary to indicate the values of the active and reactive resistance. As a result, the program allows determining the frequency characteristics of the circuit area or building feedback on the given input effect. However, the need to determine specific circuit implementations and parameters of their elements according to known frequency characteristics pose additional difficulties, and the visual graphical interface of Windows, requiring significant hardware, remains inoperative.

Another approach to simulating electrical circuits is used in the CompLab software, which allows you to create computer models of electrical systems in general, without detailing the electrical circuit to individual components. The software allows the use of different signal sources: sinusoidal, pulsed or noise, and the creation of complex signaling systems with the use of various linear (filters and delay line amplifiers) and nonlinear elements. It should be noted that in the CompLab software, the elements are specified using transfer functions. A detailed analysis of the parameters of the output signal is possible due to the use of various virtual measuring instruments: an oscilloscope, a spectroanalyzer, a correlometer, and others. [3]. Thus, the CompLab software most fully meets the requirements necessary to solve the task.

Let us consider in detail the construction of the models of processes described by equation (16). We take voltage generators  $U(t)$  as sources of disturbing effects in the case of replacing the mechanical force  $F(t)$  with the electric voltage in accordance with equation (17). In this case, the ratio of voltage levels between individual sources must correspond to the ratio of the values of the initial force effects.

So the polyharmonic force effects described by equation (5) are modeled by two generators of rectangular signals, with repetition periods equal to 20 msec and 50 msec. The periods correspond to the frequency of the power supply equal to 50 Hz and the speed of rotation of the machine rotor – 1,200 rpm. Since the generators correspond to the sources of vibrational effects with maximum power, we accept the amplitude of generators of 10 V as the reference level of signals. To limit the harmonic composition of the generator signal,



we connect low frequency filters with a cutoff frequency of 500 Hz and 200 Hz, corresponding to the tenth harmonic component according to (5), to the output of the generators.

The low-frequency vibrational forces shown in equation (8), which are not determined by time and amplitude, are represented by means of a generator of white noise and a bandpass filter with a frequency of 200 Hz.

The image of rapidly changing force effects that arise during the work of the brush-collector node and described by the equation (6) is obtained with an impulse generator. We set the period of repetition of impulses as 0.1 msec and impulse duration of 10 msec, corresponding to the speed of rotation of 1,200 rpm and the number of collector plates  $K=500$ .

In experiments for simulating the rotational speed of a machine it is necessary to change the periods of repetition of the corresponding generators' signals.

The complexity of vibration processes that arise from the operation of a defective bearing, imposes on its model several specific requirements: the repetition period of impulse signals should change randomly. In the CompLab programming system, the specified conditions are compatible with the code generator whose impulse duration is determined by the minimum simulation time. In the proposed model, this is permissible, and the repetition periods of signals are set using a sequential 32-bit binary code. A change in amplitude of the signal is ensured by the signal multiplier that is set at the outlet and controlled by a normal noise generator.

The block diagram of the model of force effects is shown in Fig. 5.

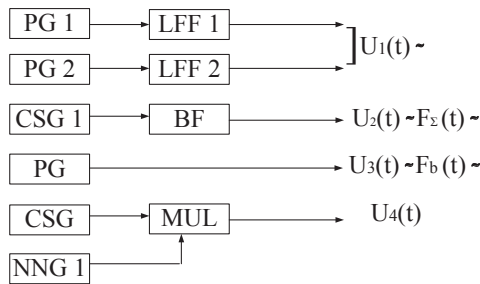

Fig. 5. A scheme of the model of force effects: PG – pulse generators; NNG – normal noise generator; CSG – code-sequence generator; LFF – low frequency filters; BF – bandpass filter; MUL – multiplier

Symbols of the functional blocks in the scheme correspond to the CompLab system designations. Fig. 6 shows a diagram of the model for the propagation of vibroacoustic effects in the parts and nodes of the electric machine from the places of origin to the point of observation.

The process model is measured and recorded with the help of the blocks for the output of the simulation results. The oscilloscope (OSC) is used to obtain the time of signal implementation. The correlometer (CORR) serves to analyze the probabilistic characteristics of the signal in the time domain. The power spectrum analyzer (PS) is used for analysis of signal parameters in the frequency domain. The signal density analyzer (DE) serves to analyze the laws of the distribution of signal amplitudes.

Fig. 6 shows that the channel for propagation of low-frequency oscillations (which corresponds to the kinematic scheme shown in Fig. 2) consists of a summator (SUM) and a bandpass filter BF 1. The channel of propagation of the signal from the brush-collector node is given

in the model as the bandpass filter BF 2. A signal ( $U_4(t)$ ) corresponding to the vibration acoustic effect from the defective rolling bearing propagates through the multiplier (MUL) and the filter BF 3. MUL corresponds to the parametric impact of low-frequency vibrations on the characteristics of the channel of propagation of high-frequency vibrations, taking into account the delay of the signal in the low-frequency channel of propagation – the regulated delay line (DL). The frequency transmission coefficients of the bandpass filters used in the model are given as fourth-order polynomials in accordance with equation (14), and the coefficient values of  $a_i$  and  $b_i$  are determined from the experimental data.

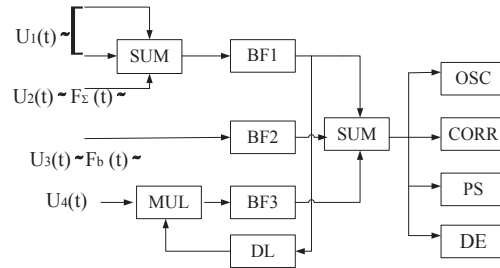

Fig. 6. A scheme of the model for the vibroacoustic effect propagation: SUM – signal summators; BF – bandpass filter; DL – delay line; OCS – oscilloscope; CORR – correlometer; PS – power spectrum analyzer; DE – signal probability density analyzer

### 5. 2. Comparing the findings on real vibration fields and the results of numerical simulation

Let us consider the results of mathematical simulation. In the first series of experiments, we simulate the vibration fields of a working electric machine with a proper bearing support. Fig. 7 shows the time implementation of the model vibration signal in the absence of shock impulses from the code-sequence generator (CSG).

A more detailed study of signals was provided by the use of a spectroanalyzer. The results of the spectral analysis of the model processes are shown in Fig. 8. A detailed analysis of the amplitude distribution of signals in the simulation was ensured by the use of the probability density analyzer.

Fig. 9, 10 give the results of measuring the law of the probability density of the instantaneous amplitudes for the simulated processes.

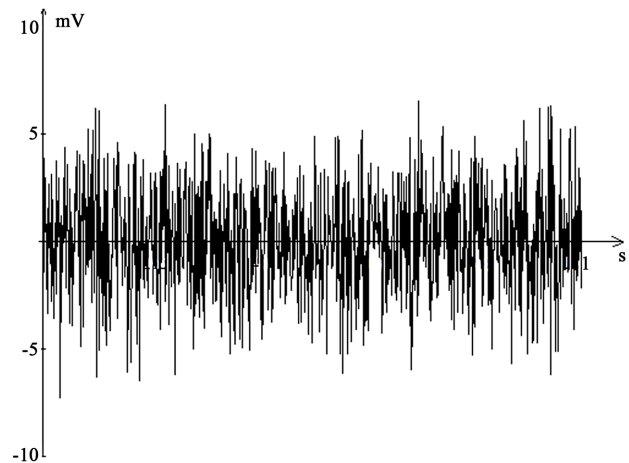

Fig. 7. Time implementation of signals in the absence of shock impulses of the code-sequence generator



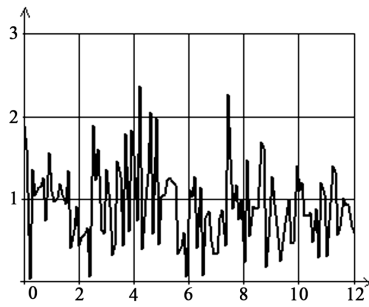

Fig. 8. Signal spectrum

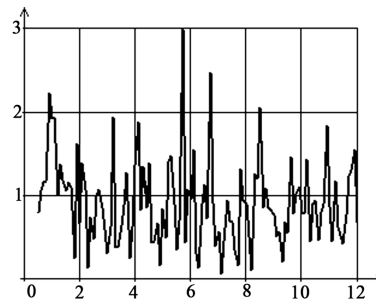

Fig. 11. A spectrogram of signals in the model with the CSG

In studying the pattern of vibration fields in the model, we analyzed the auto-correlation function of signals. The results of its measurement for normal bearings are shown in Fig. 9.

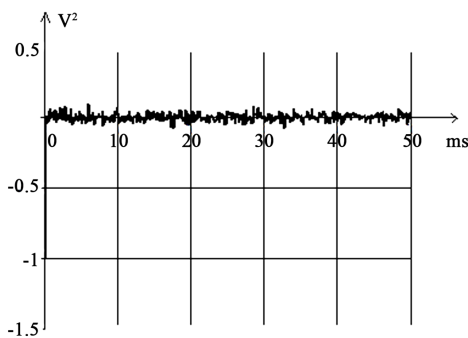

Fig. 9. An autocorrelation function of the simulated process

The results of measuring the probabilistic characteristics of the model are shown in Fig. 12.

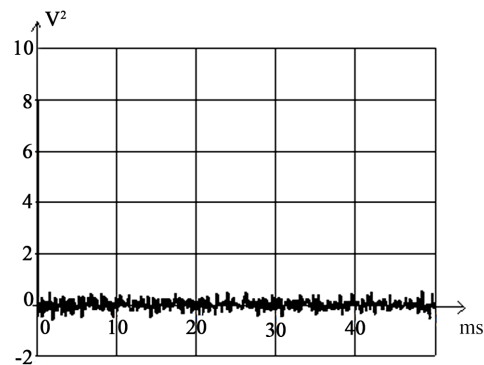

Fig. 12. The curve of the signal autocorrelation function with the CSG

As well as in the case with a real electric machine, the model vibrational signal repeats the frequency response of the channel of propagation in the absence of shock impulses from the code-sequence generator (CSG) in the frequency domain. In the amplitude domain, the distribution density is close to the normal distribution law, and the probability of signals with a large amplitude is close to zero. In the time domain, the signal lacks periodicity.

In the second series of experiments, the model included a code-sequence generator, which corresponds to the appearance of damage to the working surfaces of the bearing parts. The oscillogram of the vibration signals of the model is shown in Fig. 10, 11 shows the signal spectrum in this experiment.

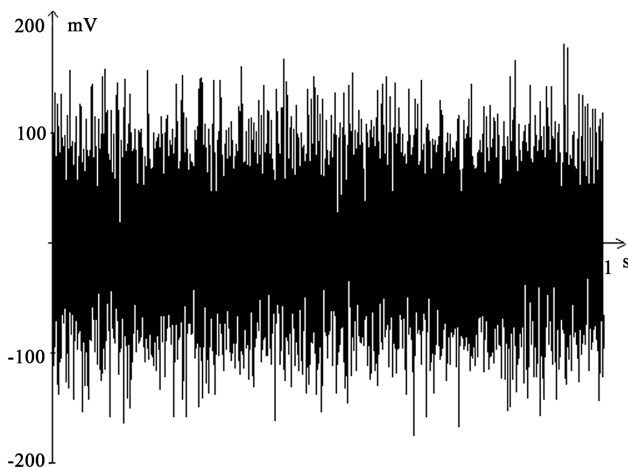

Fig. 10. Time realization of processes in the model with the CSG

The curve of the autocorrelation function demonstrates a deviation from the random process at the point of 30 ms, which corresponds to the period of repetition of the CSG.

### 6. Discussion of the results of simulation of stochastic vibration fields in sophisticated TCs

Proceeding from the latest trends in the research and implementation of technical diagnostics of complex technological systems and the need to forecast the state of their operation, we have proposed the use of a mathematical model to identify defects in rolling bearings.

In the simulation of the stochastic vibration fields of TCs, the task was to develop methods for the selection of vibration information diagnostic characteristics that would ensure an effective and reliable detection of rapidly developing defects. It is revealed that in the amplitude domain the distribution density is close to the normal distribution law and the probability of the appearance of high-amplitude signals is close to zero. This indicates that the vibration signal of the model in the absence of shock impulses of the code-sequence generator in the frequency domain repeats the frequency response of the propagation channel.

The limitation of the study is that it is not always possible to place a means of technical control on a running bearing without a partial disassembly of the TC, which requires additional time and funding.

In general, the results of simulation of stochastic fields of vibrations of electric machines allow to conclude that the occurrence of a shock pulse does not cause a significant change in the spectral characteristics of signals at the measuring

point. The autocorrelation analysis of signals also allows detecting the occurrence of pulse sequences of signals, but the sensitivity of the method is much lower. Therefore, in the future, when diagnosing bearing units, more attention should be paid to the spectral characteristics and the law of variation in the probability density of the model signal.

It is necessary to draw attention to the fact that the obtained findings on the real vibration fields and the results of numerical simulation are given only for the new defect-free bearing since it was not the purpose of the study to identify the defects or to diagnose damaged or defective objects.

The obtained results can be used for technical diagnostics aimed at reducing the cost of repair and restoration of TC nodes by means of early detection of defects originating in the nodes. The range of application of the research findings is rather wide; they can be used for any TC with rolling bearings (in particular, railway transport, TPP, hydroelectric power stations, and nuclear power plants). The difficulty of this study is the lack of a common basis for detecting defects with the help of stochastic vibration fields for each type of the bearing unit.

---

## 7. Conclusion

---

1. According to the kinematic scheme of propagation of power waves, there has been constructed a mathematical model for the formation and propagation of elastic waves in TCs from the places of their occurrence to the observation point. The peculiarity of the mathematical model is that the transmission channel is a complex system, where each link

is responsible for a certain diagnostic feature (vibration, magnetic noise, or resonance of the rolling bearing). Such a model provides a timely and reliable detection of defects without disassembling of the TC for diagnostic purposes. The constructed mathematical model is close to the real processes of formation and propagation of vibration waves in a working TC. The most sensitive parameter for detecting the flow of pulse effects in the model was the law of distribution density, especially in the zone of large amplitudes.

2. The authors have compared of the research findings on real vibration fields of electric machines with the results obtained during numerical simulation. The results of simulation have revealed the following:

- as well as in the case with a real TC, the vibrational signal of the model repeats the frequency response of the propagation channel when the code-sequence generator is turned off;
- in the amplitude domain the distribution density is close to the normal distribution law and the probability of the appearance of signals with a large amplitude is close to zero;
- in the time domain a signal can not have periodicity;
- the curve of the autocorrelation function shows a significant deviation from the random process at the point of 30 ms, which corresponds to the period of repetition of pulses of the code-sequence generator.

3. Based on the analysis of stochastic sources of vibration acoustic waves in TCs and the conducted studies, it has been proved that, in their initial stage, the defects of ball-bearing support do not significantly influence the parameters of the TC vibroactivity. This confirms the reliability of the proposed model and its adequacy to the real processes.

---

## References

1. Metody otsiniuvannia tochnosti informatsiyno-vymiriuvalnykh system diahnostryky: monohrafiya / Marchenko N. B., Nechyporuk V. V., Nechyporuk O. P., Pepa Yu. V. Kyiv: Vyd-vo PVP «Zadruha», 2014. 200 p.
2. Marchenko N. B., Nechyporuk E. P. Prichiny vozniknoveniya i klassifikaciya otkazov v tekhnicheskikh sistemah // Suchasnyi zakhyst informatsiyi. 2012. Issue 4. P. 84–87.
3. Metody obrobky vibrodiahnostychnoi informatsiyi ta pobudova na yikh osnovi system operatyvnoi diahnostryky elektrotekhnichnoho obladdnannia / Marchenko N. B., Nechyporuk O. P., Vakhil A. A., Shukalo V. V. // The Caucasus Economical and social analysis journal of southern Caucasus. 2014. Issue 3. P. 25–29.
4. Ge M., Wang J., Ren X. Fault Diagnosis of Rolling Bearings Based on EWT and KDEC // Entropy. 2017. Vol. 19, Issue 12. P. 633. doi: <https://doi.org/10.3390/e19120633>
5. Kumar M. S., Prabhu B. S. Rotating Machinery Predictive Maintenance Through Expert System // International Journal of Rotating Machinery. 2000. Vol. 6, Issue 5. P. 363–373. doi: <https://doi.org/10.1155/s1023621x00000348>
6. Xu X., Han Q., Chu F. Review of Electromagnetic Vibration in Electrical Machines // Energies. 2018. Vol. 11, Issue 7. P. 1779. doi: <https://doi.org/10.3390/en11071779>
7. Remaining Useful Life Prediction Method of Rolling Bearings Based on Pchip-EEMD-GM(1, 1) Model / Wang F., Liu X., Liu C., Li H., Han Q. // Shock and Vibration. 2018. Vol. 2018. P. 1–10. doi: <https://doi.org/10.1155/2018/3013684>
8. Abuthakeer S. S., Mohanram P. V., Mohankumar G. The Effect of Spindle Vibration on Surface Roughness of Workpiece in Dry Turning Using Ann // International Journal of Lean Thinking. 2011. Vol. 2, Issue 2. P. 42–58.
9. Li Y., Wang L., Guan J. A Spectrum Detection Approach for Bearing Fault Signal Based on Spectral Kurtosis // Shock and Vibration. 2017. Vol. 2017. P. 1–9. doi: <https://doi.org/10.1155/2017/6106103>
10. Lv Y., Zhang Y., Yi C. Optimized Adaptive Local Iterative Filtering Algorithm Based on Permutation Entropy for Rolling Bearing Fault Diagnosis // Entropy. 2018. Vol. 20, Issue 12. P. 920. doi: <https://doi.org/10.3390/e20120920>
11. Zhitomirskiy V. K. Mekhanicheskie kolebaniya i praktika ih ustraneniya. Moscow: Mashinostroenie, 1966. 175 p.
12. Tihonov V. I. Statisticheskaya radiotekhnika. 2-e izd., pererab. i dop. Moscow: Radio i svyaz', 1982. 624 p.
13. Korn G., Korn T. Spravochnik po matematike dlya nauchnykh rabotnikov i inzhenerov. Moscow: Nauka, 1977. 456 p.
14. Sposoby vydeleniya iz sobstvennoy korpusnoy vibracii dvigatelya skrytoy periodicheskoy sostavlyayushchey – defekta / Gioev Z. T., Golov Yu. V. et. al. // Elektrovozostroyeniye. 2007. Vol. 38. P. 308–319.
15. Vol'dek A. I. Elektricheskie mashiny. Vvedenie v elektromekhaniku. Mashiny postoyannogo toka i transformatory. Sankt-Peterburg: Piter, 2008. 320 p.