

MINISTRY OF EDUCATION AND SCIENCE OF UKRAINE  
NATIONAL AVIATION UNIVERSITY  
FACULTY OF ARCHITECTURE, CIVIL ENGINEERING AND DESIGN  
COMPUTER TECHNOLOGIES OF AIRPORT CONSTRUCTION AND  
RECONSTRUCTION DEPARTMENT

TO ADMIT TO GUARD

Head of the Department

\_\_\_\_\_ O.I. Lapenko

“ \_\_\_\_\_ ” \_\_\_\_\_ 2022

# BACHELOR THESIS

(EXPLANATORY NOTE)

SPECIALTY 192 «BUILDING AND CIVIL ENGINEERING»

Educational and professional program: «Industrial and civil engineering»

**Theme:** Sport arena of weightlifting gym in Bila Tserkva, Kyiv region

**Performed by:** group 406 Ba, Stoliarchuk Yuliia

**Thesis Advisor:** Ph.d., associated professor Kostyra N.O.

**Design rule check:** \_\_\_\_\_ O. Rodchenko

Kyiv 2022

NATIONAL AVIATION UNIVERSITY  
FACULTY OF ARCHITECTURE, CIVIL ENGINEERING AND DESIGN  
COMPUTER TECHNOLOGIES OF CONSTRUCTION DEPARTMENT  
Faculty of architecture, civil engineering and design  
Computer technologies of construction department  
Speciality: 192 «Building and Civil Engineering»  
Educational Professional Program: Industrial and Civil Construction

APPROVE

Head of the Department

\_\_\_\_\_ O.I. Lapenko  
“ \_\_\_\_\_ ” \_\_\_\_\_ 2022

**TASK**  
**to perform the master thesis**

Stoliarchuk Yuliia Ihorivna  
(Surname, initials of the graduate)

1. The subject of the work: «Sport arena of weightlifting gym in Bila Tserkva, Kyiv region» is approved by order of the rector from «\_\_» \_\_\_\_\_ 2022p. № \_\_\_\_\_.
2. Term of work performance: from 23.05.2022 to 19.06. 2022.
3. Initial data of the work: construction site - Bila Tserkva, Kyiv region, load according DBN "Loads and influences", engineering-geological, engineering-geodetic surveys of the construction site, district I – according to DBN "Building climatology".
4. Content of the explanatory note: Analytical review of the literature on the topic of work, architectural part (and graphic material), structural part.
5. List of required illustrative material: tables, figures, diagrams, graphs, drawings of the architectural part and the calculation and structural part.
6. Calendar schedule

№	Task	Execution period	Signature of the head
1.	Analytical review	23.05.2022	
2.	Architectural part	29.05.2022	
3.	Constructive solutions	04.06.2022	
4.	Bases and foundations	07.06.2022	
5.	Making an explanatory note	08.06.2022	

7. Consultation on separate chapters:

Chapter name	Consultant (position, surname, initials)	Date, signature	
		Task issued	Task exepcted
Analytical review	Associate Professor, Department of computer technologies in construction, Kostyra N. O.		
Architectural part	Associate Professor, Department of computer technologies in construction, Kostyra N. O.		
Constructive solutions	Associate Professor, Department of computer technologies in construction, Kostyra N. O.		
Bases and foundations	Associate Professor, Department of computer technologies in construction, Kostyra N. O.		

8. Date of issue of the task «23» \_\_\_\_\_05\_\_\_\_\_ 2022 p.

Scientific adviser:

\_\_\_\_\_

Kostyra N.O.

(signature of the head)

(surname, initials)

The task is accepted for execution:

\_\_\_\_\_

Stoliarchuk J.I.

(signature of the head)

(surname, initials)

## Content

TASK to perform the master thesis .....	1
1. Analytical review .....	4
2. Architectural Part .....	7
2.1 General data .....	7
2.2. Natural conditions .....	7
2.3. Architectural and constructive decisions .....	9
2.3.1. Thermal calculation of enclosing structures .....	12
2.3.2 Water supply and sewerage.....	16
2.3.3 Heating, ventilation and air conditioning.....	16
2.3.4 Electrical solutions .....	17
3. Constructive solutions .....	19
3.1. Estimated scheme of the rafter truss .....	19
3.2. Collecting loads .....	19
3.3. Main statements of truss calculation .....	21
3.4. Calculation of the column .....	25
3.4.1. Selection of column cross section .....	25
3.4.2. Design and calculation of the base of the through column.....	26
3.5. Structural solutions of the metal frame of the building .....	28
3.6. Calculation model and results of calculations .....	40
4. Bases and Foundations .....	47
4.1. Constructive solutions of the foundation.....	47
4.2. Calculation of columnar monolithic reinforced concrete foundation for metal columns.....	48
4.3. Analysis of engineering and geological conditions.....	49
4.4. Investigation of the conditional mark $\pm 0,000$ .....	50
4.5. Choice of a bearing layer and a mark of a sole of the base .....	50
4.6. Determining the size of the foundation .....	50
4.7. Determination of the sizes of the base and constructive calculation .....	52
4.8. Collection of loads and calculation on the foundations.....	54
4.8.1. Sediment of the foundation of extreme column .....	56
4.8.2. Sediment of the foundation of middle column .....	58
4.8.3. Sediment of the foundation of half-timbered column .....	61
Annex 1. Calculation of the class of consequences.....	65
Annex 2. Calculation of evacuation time .....	67
Conclusions .....	80
List of sources used .....	81

## 1. Analytical review

Having regard to an extraordinarily difficult situation with integrity of the Ukrainian border and destruction of the Ukrainian cities, building of the sports arena of weightlifting gym will be a good enough decision for proceeding in the infrastructure of city, that will satisfy the necessities of citizens of city Bila Tserkva in relation to of healthy lifestyle, preparation of the Ukrainian sportsmen to the olympic competitions and popularization of weightlifting among young people, and also creation of additional workplaces.

The project of the building of the sports arena of weightlifting gym is developed in accordance with all requirements of [1-3] to provide low-mobility groups and people with disabilities access to sports.

DBN B.2.2-40:2018 "Inclusive buildings and structures" are mandatory. They provide all the necessary technical characteristics of the device of barrier-free elements. In particular, the document refers to the arrangement of:

- ramps, special lifts and other means of accessibility for people with musculoskeletal disorders;
- tactile floor tiles, information tables and Braille markings, other visual elements and audio indicators for the visually impaired;
- duplication of important sound information with texts, organization of sign language translation, use of sound amplification systems for people with hearing impairments.

The practical action of the sports arena weightlifting gym will help create a universal public space accessible to everyone.

For today in Ukraine the amount of the specialized sports arenas of weightlifting gym is not considerable and majority from them is located in Kyiv and in large cities. Analysing the state of country, it follows notices, that building of sporting halls and complexes becomes an actual enough task, it is the most

effective method as it gives strengthening healthy'l citizens and development of sporting-health influence on this region.

It is difficult to overestimate the value of the sports arena weightlifting gym for regional development, especially having regard to that this instrument allows to extract maximal benefits (to fix healthy'I am nations, to attract additional investment-innovative resources and other) at possible minimum expenses. In the conditions of present time such direction of regional development is especially actual, as repressing part of region continues to be under act of negative factors that was represented on the results of economic and social development of areas and them administrative-territorial. According to the architectural and constructive decision, sports halls are usually designed and built as uniform depending on the purpose of architectural planning spaces. When choosing the construction site, the planning and transport structure of the city is taken into account.

When designing the master plan of the sports arena weightlifting gym, it is necessary to take into account certain requirements:

- a convenient network of streets that allow you to easily get to the weightlifting gym;
- compactness of the planning decision for the purpose of the organization of movement of cars of emergency services.

Equally important is the internal planning, which is inextricably linked with the use of premises. About 53% of the area of the opposite hall is occupied by the training hall, 47% are technical rooms and warehouses.

Analyzing the experience of designing foreign countries, we can note the main systems of formation of the architectural composition of gyms:

- the composition of interior spaces can be closed. When replacing the walls with columns, the spaces are combined. The lack of walls creates the conditions for creating a free composition of interiors, the depth of which depends on the structure of the building.

- free disclosure of space and creation of its depth due to any characteristic elements of the room or structures that emphasize its depth. The depth of space is also emphasized by the presence of planes coming from the observer, or the forms of the foreground, partially obscuring the forms of the background in the direction of the line of sight.

Depending on the regional centers, the architectural and planning solution of the sports arena weightlifting gym does not differ, it is possible to change only the adjacent territories. But depending on the location of scaffolding or the organization of warehouses may differ in a single plan, taking into account both the planning decision and the organizational structure of the city. The building area should occupy the estimated area according to the project. Lighting of the complex is the main method of organizing space, which allows you to make the sports arena weightlifting gym more cost-effective to maintain.

The main type of structures are columns, beams or trusses, enclosing structures, for the construction of interior space using coatings of sandwich panels, shells, etc.

The technology of fast installation which gives the chance to create one-storeyed pavilions of the big area with the minimum number of support is very widespread. This technology can provide spans up to 48 m, height 9-12 m.

Thus, the construction of the sports arenas weightlifting gyms is gradually developing in Ukraine, their location depends on the planning and transport structure of the city and the climatic conditions of the region of location. The transport accessibility of the sports arena weightlifting gym largely determines the convenience and cost-effectiveness of the facility. Flexibility of internal planning is one of the requirements that is inextricably linked with the universal use of space.

## **2. Architectural Part**

### **2.1 General data**

The current project involves the sport arena of weightlifting gym in Bila Tserkva, Kyiv region.

The allotted area for construction meets the standard requirements.

General characteristics of the house::

- class of consequences - CC1;
- degree of fire resistance - III a;
- degree of durability - I - public with a service life of over 100 years..

The calculation of the class of consequences is given in Annex 1.

The site allocated for construction meets the standard requirements.

The level of clean floor of the 1st floor is taken as a conditional mark of 0.000, which corresponds to the absolute mark of 177.78.

The construction of the sport arena of weightlifting gym in Bila Tserkva, Kyiv region is being carried out in one turn.

### **2.2. Natural conditions**

#### **Technical documentation and data of engineering surveys.**

In 2021, engineering and geodetic and engineering and geological surveys were performed at the site. The results of geological surveys of the site where the sport arena of weightlifting gym in Bila Tserkva, Kyiv region will be located, are presented in the Technical Report on Engineering and Geological Surveys, code 10 / 12-2021-B from 2021, developed by KYIVGEOK. Load-bearing soil IGE - 3 - heavy loam, dusty with impurities of organic matter, with layers of light loam, dark gray to black, solid consistency.



## Master Plan

The state-owned construction site has a rectangular shape in plan and is located on the street. Nekrasova, 121 in Bila Tserkva designed building is located on the south side of the site. The total area of the site is 2.4017 hectares[18].

The architectural and planning organization of the site is carried out directly around the construction site, the pedestrian and transport communication of the building is carried out in combination with the existing territory and the formed buildings.

The design takes into account urban conditions, location of the site, surrounding buildings and its nature, number of storeys, natural environment.

The passage for the fire truck is provided around the designed building on all sides.

The location of the projected building does not worsen the conditions of the school, insolation, congestion of infrastructure and utilities.

Location of the site in Bila Tserkva

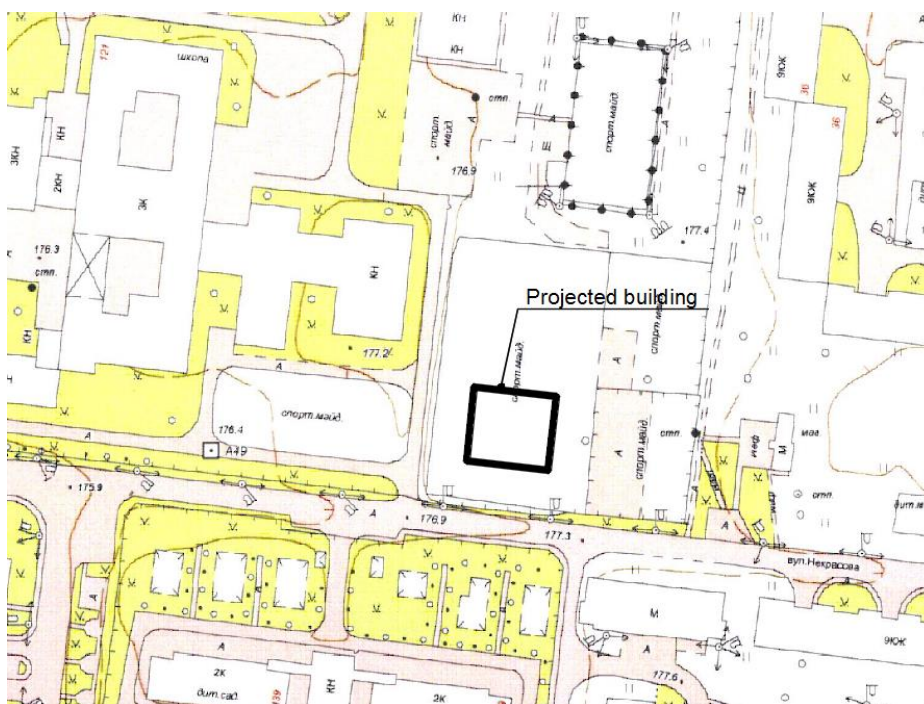

Technical and economic indicators of the building are presented in Table 2.1[4,14]

## Technical and economic indicators of the building

No	Name	Unit	Quantity
1	Site area	ha	2,4017
2	Building area	m <sup>2</sup>	504.0
3	Construction volume of the sport arena	m <sup>3</sup>	3710.47
	above the 0.000 mark	m <sup>3</sup>	3640.61
	below the 0.000 mark	m <sup>3</sup>	69.86
4	Area of roads, passages	m <sup>2</sup>	651
5	Sidewalk area	m <sup>2</sup>	715
6	Landscaping area	m <sup>2</sup>	1245

### 2.3. Architectural and constructive decisions

The project envisages the sport arena of weightlifting gym in Bila Tserkva, Kyiv region.

The conditional mark of 0.000 is the level of the clean floor of the first floor, which corresponds to abs. resp. 177.78.

The sport arena of weightlifting gym consists of two span system building with two different heights. For the middle part of the building (at the point of height difference) the foundations for the columns of both frames are common, for the extreme columns (as well as half-timbered) separate foundations are arranged for each frame. The foundations of the building are columnar monolithic reinforced concrete made of concrete class C20 / 25 (B25), W6, F200[7,19]; reinforcement of class A500C, A240C[20]. Under the base of foundations, a 100 mm thick preparation made of C8 / 10 concrete and a 100 mm thick crushed stone preparation will be installed. Along the perimeter of the building self-bearing foundation beams are arranged as building envelope, which rest on reinforced concrete columns (section 300x300 mm), standing on the base of the main foundations. Concrete of foundation beams and columns of class C20 / 25 (B25), W6, F200; reinforcement of class A500C, A240C. Structural scheme of the building - steel frame structure (which, in fact, carried out the installation of all components).

Steel structures are made of rolled steel grade C245. All steel structures must be covered with corrosion protection.

The following cross-sections of load-bearing elements are used:

- main columns - 2 channels №27II (box section);
- half-timbered columns - square steel profile tube 140x4;
- chord- square steel profile tube 120x4;
- racks and struts of trusses - square steel profile tube 80x4;
- supporting struts of trusses - square steel profile tube 100x4;
- struts on columns and bottom chord of truss- square steel profile tube 80x4;
- vertical brace between columns and trusses - square steel profile tube 100x4; 60x4;
- horizontal brace on chord of truss- 120x4 square pipe;
- purlins of cover - channels №24 II;
- spacers between the purlins - square steel profile tube 40x4;
- brace on the spacers of purlins - square steel profile tube 80x4.

The project provides for the placement of passage between the truss of sheet metal on the steel beams with a fence of not less than 1.2 m for access to ventilation systems.

The ground floor covering is provided with a thickness of 200 mm of concrete C20 / 25 (B25), W6, F200; reinforcement of class A500C, A240C. Before installing the slab, it is necessary to perform 100 mm thick preparation of C8 / 10 concrete and 100 mm thick crushed stone preparation.

Exterior enclosing structures - the walls are made of sandwich panels with a thermal lock with a filler of mineral wool ( $\rho = 30 \text{ kg /m}^3$ ,  $\lambda = 0,05 \text{ W/(m}\cdot\text{K)}$ ) [8-13,22].

Internal walls - masonry of clay solid brick M150 on cement-sand mortar M100 with bandaging joints and mandatory reinforcement, thickness 380 and 250 mm. Partitions - masonry of clay solid brick M150 on cement-sand mortar M100

with bandaging joints and mandatory reinforcement, 120 mm thick. Jumpers for indoor door blocks made of steel corners 50x5 and 100x5 mm.

Vent ducts - masonry ducts are made of clay solid brick M150 on cement-sand mortar M100 with bandaging seams and mandatory reinforcement.

Window blocks are metal-plastic, provided with an inclined-rotating opening mechanism, energy-saving. Stained-glass windows are metal-plastic and aluminum infusion-crossbar system. Door blocks are metal and metal-plastic, non-threshold (maximum allowable threshold of 20 mm).

The roof is combined, made of typesetting sandwich. The upper layer - profiled sheet T35E, waterproofing, mineral wool 300 mm high, density 30 kg / m<sup>3</sup>[22] (in the body of mineral wool Z-beams with a step of 600 mm), vapor barrier layer, the lower load-bearing profiled sheet T60 - below - metal beams.

Arrange the floors in accordance with the marking plans and explications of the floors. The main coatings are ceramic non-slip tiles, wear-resistant commercial linoleum and sports linoleum.

Finishing of internal walls and partitions correspond to technological process in rooms. Ceilings in the building to perform Armstrong or suspended GKL.V.

Paving should be 2 m wide with a coating of FEM tiles on a concrete reinforced base.

In the basement there is a room for connecting water supply, sewerage and heating. Electrical panel GRP-1 is located in room №2.

### 2.3.1. Thermal calculation of enclosing structures

- Thermal calculation of the outer wall of the building (sandwich panel fig 2.1.) [9]

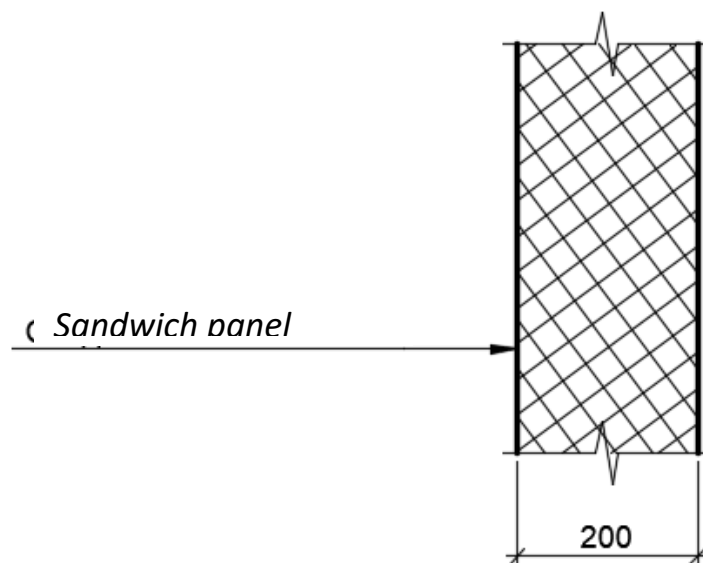

Fig. 2.1. Sandwich panel

1. Sandwich panel:

$$\delta = 200 \text{ mm}, R_{qmin} = 4,6 \text{ (m}^2 \cdot \text{K)/W};$$

According to annexB according to DSTU BV 2.6-189: 2013 [9] heat transfer coefficients:

$\alpha_B$  - the estimated value of the heat transfer coefficient of the inner surface of the enclosing structure is– 8,7;

$\alpha_3$  - the estimated value of the heat transfer coefficient of the inner surface of the enclosing structure is– 23;

The minimum allowable value of heat transfer resistance for the outer wall:

$$R_{qmin} = 3,3 \text{ (m}^2 \cdot \text{K)/W}$$

$$R_{qmin} = \frac{1}{\alpha_B} + \frac{\delta_1}{\lambda_1} + \frac{1}{\alpha_3} \quad (2.2)$$

Calculate the reduced heat transfer resistance of the wall from the finished sandwich panel, 200 mm thick.

$$R_{q_{\text{неп.}}} = \frac{1}{8,7} + 4,6 + \frac{1}{23} = 4,75 \text{ (m}^2 \cdot \text{K)/W}$$

$$R_{q_{\text{ср.}}} = 4,75 \text{ (m}^2 \cdot \text{K)/BТ} > R_{q_{\text{min}}} = 3,3 \text{ (m}^2 \cdot \text{K)/W}$$

Condition (4) DBN B.2.6-31: 2016 [8] is fulfilled

- Thermal calculation of the combined covering of the building (fig. 2.2.) [9]

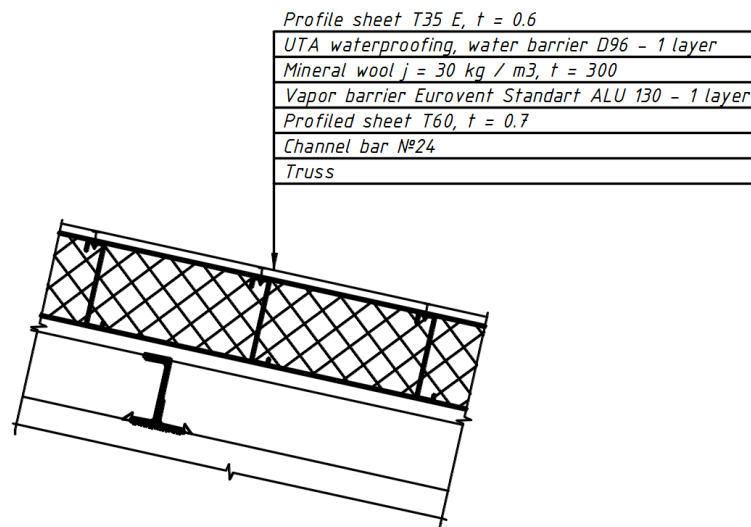

Fig. 2.2. The combined covering of the building

The calculation of the reduced heat transfer resistance did not take into account the inclusion of a layer of profiled sheets, waterproofing and vapor barrier, as its quantitative expression does not significantly affect the reduced heat transfer resistance of the structure as a whole.

1. Profiled sheet T35E,  $\delta = 0,6 \text{ mm}$ ;
2. Waterproofing - 1 layer;
3. Heat-insulating mineral wool plate  $\rho = 30 \text{ kg / m}^3$ ,  $\lambda = 0,05 \text{ W/(m}\cdot\text{K)}$ ;
4. Vapor barrier - 1 layer;
5. Profiled sheet T60,  $\delta = 0,7 \text{ mm}$ ;

According to annex B according to DSTU BV 2.6-189: 2013 heat transfer coefficients:

$\alpha_B$  - the estimated value of the heat transfer coefficient of the inner surface of the enclosing structure is - 8,7;

$\alpha_3$  - is the calculated value of the heat transfer coefficient of the inner surface of the enclosing structure, which is - 23;

Minimum allowable value of heat transfer resistance for combined coating:

$$R_{qmin} = 4,95 (m^2 \cdot K)/B\tau$$

$$R_{qmin} = \frac{1}{\alpha_B} + \frac{\delta_3}{\lambda_3} + \frac{1}{\alpha_3} (2.3)$$

$$\delta_2 = \left( R_{qmin} - \frac{1}{\alpha_B} - \frac{1}{\alpha_3} \right) * \lambda_3 = \left( 6,0 - \frac{1}{8,7} - \frac{1}{23} \right) * 0,05 = 0,292 (m)$$

Calculate the reduced heat transfer resistance of the combined coating with insulation with a total thickness of 300 mm.

$$R_{qпер.} = \frac{1}{8,7} + \frac{0,3}{0,05} + \frac{1}{23} = 6,15 (m^2 \cdot K)/W$$

$$R_{qст.} = 6,15 \frac{m^2 \cdot K}{B\tau} > R_{qmin} = 4,95 (m^2 \cdot K)/W$$

Condition (4) DBN B.2.6-31: 2016 [8] is fulfilled

- Thermal calculation of the floor over the unheated basement (fig. 2.3.) [9]

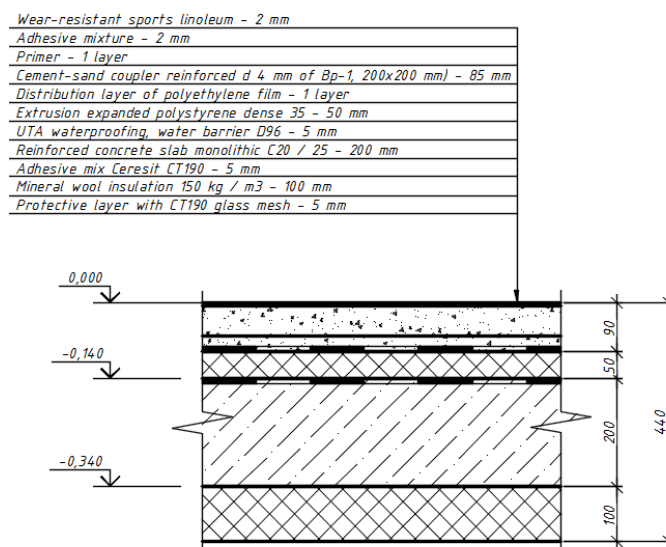

Fig. 2.3. The floor over the unheated basement

1. Linoleum wear-resistant commercial:

$$\delta = 2 \text{ mm}, \rho = 1800 \text{ kg /m}^3, \lambda = 0,38 \text{ W/(m}\cdot\text{K)}$$

2. Coupling c /n:  $\delta = 90 \text{ mm}, \rho = 1800 \text{ kg /m}^3, \lambda = 0,93 \text{ W/(m}\cdot\text{K)}$

3. Plate heat-insulating EPS:

$$\delta = 50 \text{ mm } \rho = 35 \text{ kg /m}^3, \lambda = 0,037 \text{ W/(m}\cdot\text{K)}$$

4. Slab contraction joints:

$$\delta = 200 \text{ mm}, \rho = 2500 \text{ kg /m}^3, \lambda = 2,04 \text{ W/(m}\cdot\text{K)}$$

5. Mineral wool heat-insulating plate (from the side of the technical room):

$$\rho = 150 \text{ kg /m}^3, \lambda = 0,05 \text{ W/(m}\cdot\text{K)}$$

According to annex B according to DSTU BV 2.6-189: 2013 heat transfer coefficients:

$\alpha_B$  - the estimated value of the heat transfer coefficient of the inner surface of the enclosing structure is– 8,7;

$\alpha_3$  - the estimated value of the heat transfer coefficient of the inner surface of the enclosing structure is– 17;

The minimum allowable value of heat transfer resistance for the basement floor:

$$R_{qmin} = 3,75 \text{ (m}^2 \cdot \text{K)/W}$$

$$R_{qmin} = \frac{1}{\alpha_B} + \frac{\delta_1}{\lambda_1} + \frac{\delta_2}{\lambda_2} + \frac{\delta_3}{\lambda_3} + \frac{\delta_4}{\lambda_4} + \frac{\delta_5}{\lambda_5} + \frac{1}{\alpha_3} \quad (2.4)$$

$$\begin{aligned} \delta_5 &= \left( R_{qmin} - \frac{1}{\alpha_B} - \frac{\delta_1}{\lambda_1} - \frac{\delta_2}{\lambda_2} - \frac{\delta_3}{\lambda_3} - \frac{\delta_4}{\lambda_4} - \frac{1}{\alpha_3} \right) * \lambda_5 \\ &= \left( 3,75 - \frac{1}{8,7} - \frac{0,002}{0,38} - \frac{0,09}{0,93} - \frac{0,05}{0,037} - \frac{0,2}{2,04} - \frac{1}{17} \right) * 0,05 = 0,100 \text{ (m)} \end{aligned}$$

Accepted insulation with a thickness of 100 mm (in the calculation adopted insulation with an estimated (under operating conditions) thermal conductivity of not less than 0.048 W / (mK)), (according to the test report), according to technological calculations.

Calculate the reduced heat transfer resistance of the wall with mineral wool insulation, 100 mm thick.



$$R_{q_{\text{нep.}}} = \frac{1}{8,7} + \frac{0,002}{0,38} + \frac{0,09}{0,93} + \frac{0,05}{0,037} + \frac{0,2}{2,04} + \frac{0,1}{0,048} + \frac{1}{17} = 3,8 \text{ (m}^2 \cdot \text{K)/W}$$

$$R_{q_{\text{сr.}}} = 3,8 \frac{\text{M}^2 \cdot \text{K}}{\text{BT}} > R_{q_{\text{min}}} = 3,75 \text{ (m}^2 \cdot \text{K)/W}$$

Condition (4) DBN B.2.6-31: 2016 [8] is fulfilled

### 2.3.2 Water supply and sewerage

Household water supply is provided by a permanent external water supply network. Water complies with [5,26]. To meet the drinking needs of the building, the project requires the installation of a hot and cold water supply system. Hot water supply is provided by electric water heaters. Hot and cold water supply through faucets. Accounting for used water by a water meter, which is installed in the basement. Watering taps are installed for wet cleaning of premises. Install the water tap at a height of 0.5 m from the floor level. External watering taps have been installed outside in the summer to clean the surrounding area. In winter, disconnect the water tap from the mains and empty the pipes. Cold and hot water supply pipelines are mounted from polypropylene pipes. Lay water supply pipelines in thermal insulation. Laying of pipelines is performed in the floor construction. Pipelines, at the intersection of walls, ceilings and partitions, lay in the sleeves of non-combustible materials. The edge of the sleeves operates at the same level with the surface of the wall and ceiling, but 30 mm above the surface of the clean floor. Filling gaps in pipelines requires non-combustible materials that provide the normative limit of fire resistance. All used equipment and materials certified on the territory of Ukraine must have technical passports. Installation of the water supply system should be carried out in accordance with DBN B.2.5-64: 2012 "Internal water supply and sewerage of buildings"[5] .

### 2.3.3 Heating, ventilation and air conditioning

Heat supply of the building of the weightlifting gym in Bila Tserkva, Kyiv region is provided from the external heating network. The heat carrier for the heating system is water with parameters of 80 - 60 ° C. The horizontal heating

system is two-pipe. "Kermi" steel heating panels are accepted as heating devices. Removal of air from the system is carried out in the upper points of the spitting devices. Spitting devices are equipped with thermal heads for temperature regulation. Installation of the heating system should be carried out in accordance with [21,23,24]. After installation of the heating system to carry out its hydraulic test and adjustment. All used equipment and materials are certified on the territory of Ukraine and have technical passports.

The project envisages a supply and exhaust ventilation system with recuperation.

Estimated air parameters: air temperature, relative humidity and indoor air velocity adopted in accordance with [21,1]. and are provided by the ventilation systems accepted in the project. In order to create the necessary state of the air environment in the premises, in accordance with the established sanitary norms of the microclimate, the project envisages general exchange supply and exhaust ventilation with mechanical motivation.

Supply and exhaust ventilation systems are designed individually for functional groups of rooms.

For the organization of air exchange in the building there are supply and exhaust units of the company "Vents" (PV1-PV2) and supply installation P1. Heating of supply air in the cold period of the year is carried out by electric heaters. To clean the outside air, the supply units are designed with a filter not lower than the 4th cleaning class. Air intake for supply systems to perform on resp. not less than 2.2 m above ground level.

This project provides for the installation of multi-split systems with cassette indoor units. The project adopted equipment from Gree. Laying of freon pipes is provided in the insulation under the ceiling.

### **2.3.4 Electrical solutions**

The section of electrical solutions is made in accordance with DBN B.2.5-23: 2010 "Design of electrical equipment for civil purposes"[6].

For the reception and distribution of electricity, the building provides for the installation of an input-distribution cabinet (GRP-1.1), located in the technical room. The number and parameters of protective equipment are determined depending on the power of the installed electrical equipment according to the project. For grounding, the system of three-phase current with deadfly grounded neutral, with grounding system TN-C-S is accepted.

Electrical networks are made: group networks of lighting and sockets - are made of copper wires with gasket hidden in corrugated pipes with overhead brackets.

Group networks are three-wire, the supply line - four-wire (as a protective PE conductor is the grounding circuit of the building). For electric lighting of the building, a system of general uniform artificial lighting is provided, which is performed by lamps with LED lamps. Placement of lamps is accepted according to the lighting calculation according to the norms of illumination [8].

Emergency (evacuation) lighting is installed on the evacuation routes, which is performed by lamps with LED lamps and in emergency mode is powered by its own batteries.

Lighting control is performed manually from the switches located on the side of the door handle to open. Installation height 900 mm from the level of a clean floor.

Technical accounting of consumed electricity is performed by meters installed in the cabinet GRP-1.1.

The list of types of work for which it is necessary to make measurement protocols: - measurement of insulation resistance of wires and cables;

- measurement of the resistance of the loop "phase-zero";
- measuring the resistance of the earthing device.

### 3. Constructive solutions

#### 3.1. Estimated scheme of the rafter truss

Triangular truss. Lattice system - triangular with additional racks. Cross-sections of truss elements – profiles steel bent closed welded square and rectangular for building constructions, DSTU B B.2.6-8-95 (GOST 30245-94) [17], connected in taur. Construction material - steel C245,  $R_y = 24 \text{ kH/cm}$  ,. The size of the panel is 1.5 m. The geometric diagram of the truss is shown in Fig. 3.1.

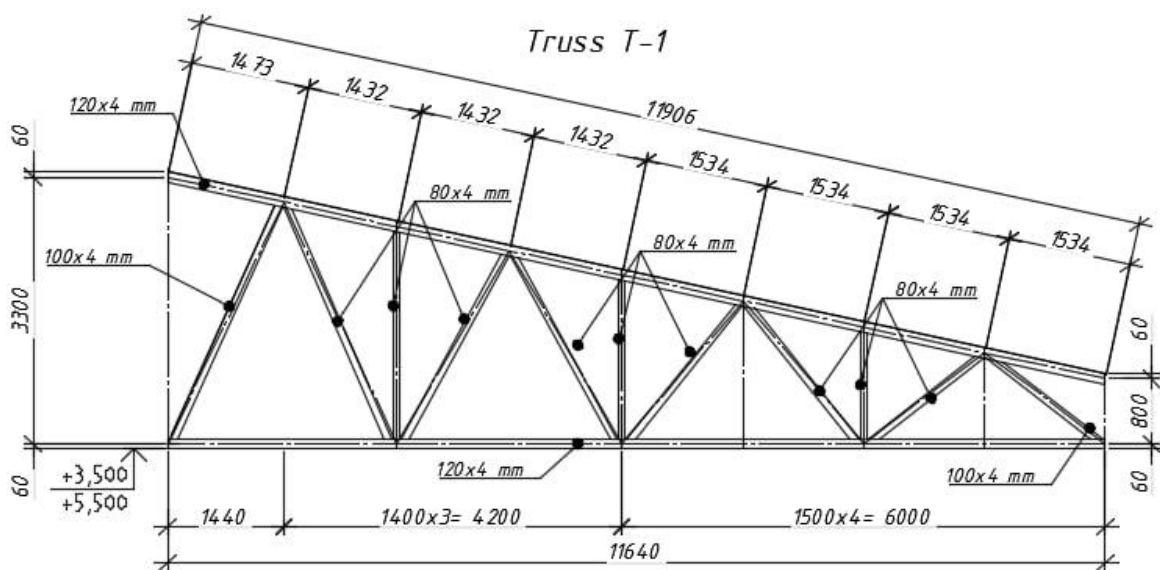

Fig. 3.1. Geometric scheme of truss

#### 3.2. Collecting loads

Constant loads from the coating. Collection of loads per  $1\text{m}^2$  of horizontal surface from the structures of the coating is performed in table 3.1.

Table 3.1

## Calculation of service and limit rating loads applied to the frame

№	Name	Service rating load $g_{xap}$ , $kN/m^2$	$\gamma_{fm}$	Limit rating load $g_{rp}$ , $kN/m^2$
1	2	3	4	5
Constant load				
Load on $1m^2$				
1	Roofing sandwich panel	0,37	1,3	0,48
2	Purlins	1,1	1,05	1,15
3	Own weight of structures	0,156	1,05	0,164
4	Bracings	0,05	1,05	0,053
<b>Total</b>		1,68		1,85
Changeable loads				
Load on $1m^2$				
3	Snow load	1,55	1,14	1,77

**Snow load**

Limit rating value of snow load per  $1m^2$  of horizontal projection of the roof is calculated by the formula (4.1):

$$S_m = \gamma_{fm} \cdot S_0 \cdot C, kN/m^2 \quad (8.2 [25])$$

(3.1)

$$S_m = 1.14 \cdot 1.55 \cdot 1 \Rightarrow 1.77 kN/m^2,$$

where  $\gamma_{fm}$  - coefficient of reliability on limit value of snow load that depends on assumed average period of repetition  $T$  and for prefabricated construction period of repetition  $T = T_{ef}$  and  $T_{ef}$  available from (B) its term of working conditions and for industrial buildings assume 60 years.

$$\gamma_{fm} - \text{available from table 8.1 and } \gamma_{fm} = 1.04.$$

$S_0$  - its characteristic value of snow load for region of building in accord with fig.8.1 or appendix E.

$$S_0 = 1.55 \text{ kN/m}^2 \text{ (kPa)},$$

$C$  – coefficient that is calculated by the formula:

$$C = \mu \cdot C_e \cdot C_{alt}, \quad (3.2)$$

$$C = 1 \cdot 1 \cdot 1 = 1,$$

where  $\mu$  - coefficient of conversion from weight of snow cover on ground to the snowload on roofing that depends on contour of covering, coefficient  $\mu$  available from appendix Ж and assume scheme №1 for industrial buildings with longitudinal monitors.

Coefficient  $C_e$  coefficient that takes into account influence of working conditions on accumulation snow (cleaning, melting) on the roof – paragraph 8.9 ДБН [25] (for heated building assume  $C_e = 1.0$ ).

$C_{alt}$  - coefficient that depends on height (H, km) of arrangement of building above sea level:

$$\text{If } H < 0.5 \text{ km, } C_{alt} = 1.0.$$

### 3.3. Main statements of truss calculation

$$q'_{m.r} \begin{cases} \text{Mass of roofing } g_{m.r} = 0.48 \text{ kN/m}^2 \\ \text{Mass of purlins } g_{m.pur} = 1.15 \text{ kN/m}^2 \\ \text{Mass of truss } g_{m.tr} = 0.164 \text{ kN/m}^2 \\ \text{Mass of rbracing } g_{m.bra} = 0.053 \text{ kN/m}^2 \end{cases}$$

$$q'_{m.r} = (\sum 1.4) \cdot B \cdot \gamma_c = (0.48 + 1.15 + 0.164 + 0.053) \cdot 6 \cdot 0.95 \\ = 10.53 \text{ kN/m}^2$$

$d$  - the panel of top chord equals 1.5 m

$$F_1 = q'_{m.r} \cdot d = 10.53 \cdot 1.5 = 15.795 \text{ kN}$$

$$F_2 = q'_{m.r} \cdot (d \cdot 0.5) = 10.53 \cdot 0.75 = 7.898 \text{ kN}$$

$$\lambda_x = \lambda_y$$

1) If  $l_x = l_y$  (bottom chord truss) more rational cross-section are designed from two unequal legs angles.

The thickness of fish plate depends on efforts in elements:

<250	260-400	410-600	610-1000	1010-1400	1410-1800	>1800
8	10	12	14	16	18	20

2)  $l_y = 2 l_x$  (top chord truss)

3) For compressed brace elements and post when:

$$l_{ef,x} = 0.8l$$

$$l_{ef,y} = l$$

The thickness of the fish plates is assumed in accord with maximum efforts for all truss but if truss span more than 36m you can assume two fish plates with different thickness but the difference between them is not more than 2mm.

Number of angles type in truss not more than 5-6 for 30m span and not more than 7-8 for 36m span. For 36m span roof truss as rule cross-section of the chord is changed by its width (not thickness). Bearing braces usually assume similar to the compressed chord, for braces use one or two types of cross-section and posts equal each other.

From the plane of action of the reference moment: for the upper belt; for the lower belt, the estimated length is equal to the distance between the fastening nodes; for lattice elements.

$$l_y = l; l_x = l.$$

Selection of sections of compressed rods is determined by the condition of stability:

$$\sigma = N/(\varphi A) \leq R_y \gamma_c \quad (3.3)$$

Selection of sections of stretched rods is determined by the condition of strength:

$$\sigma = N/A \leq R_y \gamma_c \quad (3.4)$$

At preliminary selection flexibility  $\lambda$  for belts is accepted 60 ... 80, for a lattice- 100 ... 120.

The actual flexibility of the rods should not exceed the limit, which is determined by ДБН В.1.2-2:2006 «Навантаження і впливи» [25].

### Bottom chord of the truss

Choice the cross-section for tensioned elements:

$$N_{b, \text{chord}} = 401.1 \text{ kN}$$

$$l_{ef, x} = 3.0 \text{ m}$$

$$l_{ef, y} = 6.0 \text{ m}$$

$$\gamma_c = 0.95$$

$$\lambda_u = 400$$

$$\text{For steel C245} \Rightarrow R_y = 240 \text{ MPa} = 24 \text{ kN/cm}^2$$

$$A_{nec} = \frac{N}{R_y \cdot \gamma_c} = \frac{401.1}{24 \cdot 0.95} = 17.6 \text{ cm}^2$$

$$i_x = i_y = \frac{l_{ef}}{\lambda_u} = \frac{600}{400} = 1.5 \text{ cm}$$

Assume from catalogue:

□ 120x4 mm (DSTU B B.2.6-8-95)

$$i_x = 4.71 \text{ cm}$$

$$i_y = 4.71 \text{ cm}$$

$$A = 18.5 \text{ cm}^2$$

$$\sigma_{max} = \frac{N}{A} = \frac{401.1}{18.5} = 21.68 \text{ kN/cm}^2 < 22.8 \text{ kN/cm}^2$$

Conclusion: the strength is provided.

$$\lambda_x = \frac{300}{4.71} = 63.7 < 400$$

$$\lambda_y = \frac{600}{4.71} = 84.9 < 400$$

Conclusion: the stability is provided.

### Top chord of the truss

$$N_{t, \text{chord}} = -190.44 \text{ kN}$$



$$l_{ef,x} = 3.0 \text{ m}$$

$$l_{ef,y} = 6.0 \text{ m}$$

$$\gamma_c = 0.8$$

$$\lambda_u = 180 - 60\alpha$$

$$\alpha = \frac{N}{\varphi \cdot A \cdot R_y \cdot \gamma_c}, \text{ but not more than } 0.5$$

Assume for the first type:

$$\lambda = 80 \dots 100 \text{ (chord and bearing brace)}$$

$$\lambda = 100 \dots 120 \text{ (chord type compressed brace)}$$

$$\bar{\lambda} \Rightarrow \varphi = 0.542 \text{ (Ж. 1)}$$

$$A_{nec} = \frac{N}{\varphi \cdot R_y \cdot \gamma_c} = \frac{190.44}{0.542 \cdot 24 \cdot 0.8} = 18.3 \text{ cm}^2$$

Assume from catalogue:

$$\square 120 \times 4 \text{ mm}$$

$$i_x = 4.71 \text{ cm}$$

$$i_y = 4.71 \text{ cm}$$

$$A = 18.5 \text{ cm}^2$$

$$\lambda_x = \frac{l_{ef,x}}{i_x} = \frac{300}{4.71} = 63.7$$

$$\lambda_y = \frac{l_{ef,y}}{i_y} = \frac{600}{4.71} = 127.38 \Rightarrow \bar{\lambda} = 1.37 \Rightarrow \varphi = 0.905$$

$$\sigma_{max} = \frac{N}{\varphi \cdot A} = \frac{190.44}{0.905 \cdot 18.5} = 10.84 \text{ kN/cm}^2 < 19.2 \text{ kN/cm}^2$$

Conclusion: the strength is provided.

$$\alpha = \frac{N}{\varphi \cdot A \cdot R_y \cdot \gamma_c} = \frac{190.44}{0.905 \cdot 18.5 \cdot 24 \cdot 0.8} = 0.56$$

$$\lambda_u = 180 - 60\alpha = 180 - 60 \cdot 0.56 = 146.14 > 127.38$$

### 3.4. Calculation of the column

#### 3.4.1. Selection of column cross section

Determine the estimated length of the column:

$$l = 9,08\text{m}$$

$$l_x = l_y = 0,7l = 1 \cdot 9,08 = 9,08 \text{ m}$$

The design force in the column is equal to  $N = 1518,48\text{kN}$  plus taking into account 1% of the load on the own weight of the column.

Steel for a column take C245 ( $R_y = 240 \text{ MPa}$ ).

$\lambda = 35$  (according to the schedule of flexibility)

According to the table we find the coefficient  $\varphi = 0,8$

Required column cross-sectional area:

$$A = \frac{N}{\varphi \cdot R_y \cdot \gamma_c} = \frac{1518,48}{0,9 \cdot 24 \cdot 1} = 70,3 \text{ cm}^2$$

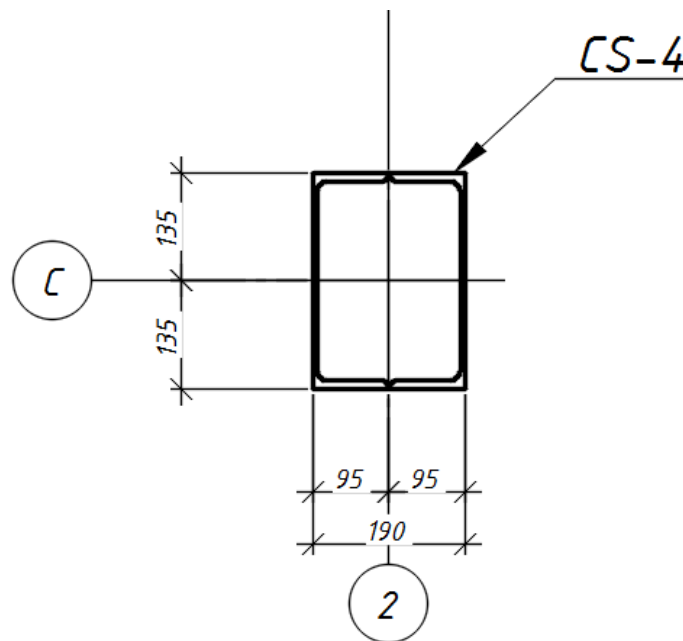

Fig.3.2. Cross section of the column

We take the assortment of two channels (fig. 3.2.):

$$2 [ 27\Pi \text{ with area } A = 2A_1 = 2 \cdot 35,2 = 70,4 \text{ cm}^2$$

According to the assortment we determine the running data of the channel and its parameters:

$$i_x = 10,9 \text{ cm} \quad I_x = 4180 \text{ cm}^4 \quad h = 270 \text{ mm} \quad s = 6,0 \text{ mm}$$

$$i_y=2,99 \text{ cm} \quad I_y=314 \text{ cm}^4 \quad b=95 \text{ mm} \quad t=10,5 \text{ mm}$$

Check the stability of the column relative to the material axis:

$$\lambda_x = \frac{l_{ef}}{i_x} = \frac{908}{10,9} = 83,3; \quad \varphi = 0,957$$

$$\sigma = \frac{1518,48 \cdot 10}{0,957 \cdot 70,4 \cdot 1} = 225,6 \text{ MPa} < R_y \gamma_c = 240 \text{ MPa}$$

Stability is provided with a margin of safety.

Calculate the flexibility relative to the free axis:

$$\lambda_{y,cal} = \frac{\lambda_x}{\nu} = \frac{83,3}{1,25} = 44$$

$\nu_x$  coefficient at

$$\lambda_x > 80, \text{TOU} = 1,15 \dots 1,20$$

$$\lambda_x < 80, \text{TOU} = 1,20 \dots 1,30$$

### 3.4.2. Design and calculation of the base of the through column

The design of the base is hinged, as provided.

We take concrete of the base C20 / 25.

The internal resistance of concrete is selected according to table 3.2.

Table 3.2.

The internal resistance of concrete

Concrete class	C8/10	C10/15	C12/15	C10/15	C15/20	C20/25
R <sub>b</sub> , MPa	4,5	6	7,5	8,5	11,5	14,5

Concrete grade C20/25 (R<sub>b</sub> = 14,5MPa = 1,54 kN/cm<sup>2</sup>)

Take the ratio of the area of the upper ledge of the foundation

Determine the desired area of the base plate

$$A \geq \frac{N_{max}}{\psi R_b} = \frac{1518,48}{1,2 \cdot 1,45} = 867,7 \text{ cm}^2$$

Determine the geometric dimensions of the base plate

One of the sides of the plate is usually determined constructively, for example its length:

$$L = b + 2a = 270 + 2 \cdot 190 = 650 \text{ mm} = 65 \text{ cm}$$

Knowing the required area of the base plate  $A = 867.7 \text{ cm}^2$  and the length  $L = 64 \text{ cm}$  determine the desired width of the plate:

$$B = \frac{A}{L} = \frac{867,7}{65} = 13,35 \text{ cm}$$

Which is approximately equal to the height of the channel of the column branch, so the actual width of the base plate is determined based on design feasibility (fig. 3.3.):

$$B = h + 2 \cdot c = 190 + 2 \cdot 105 = 400 \text{ mm} = 40 \text{ cm}$$

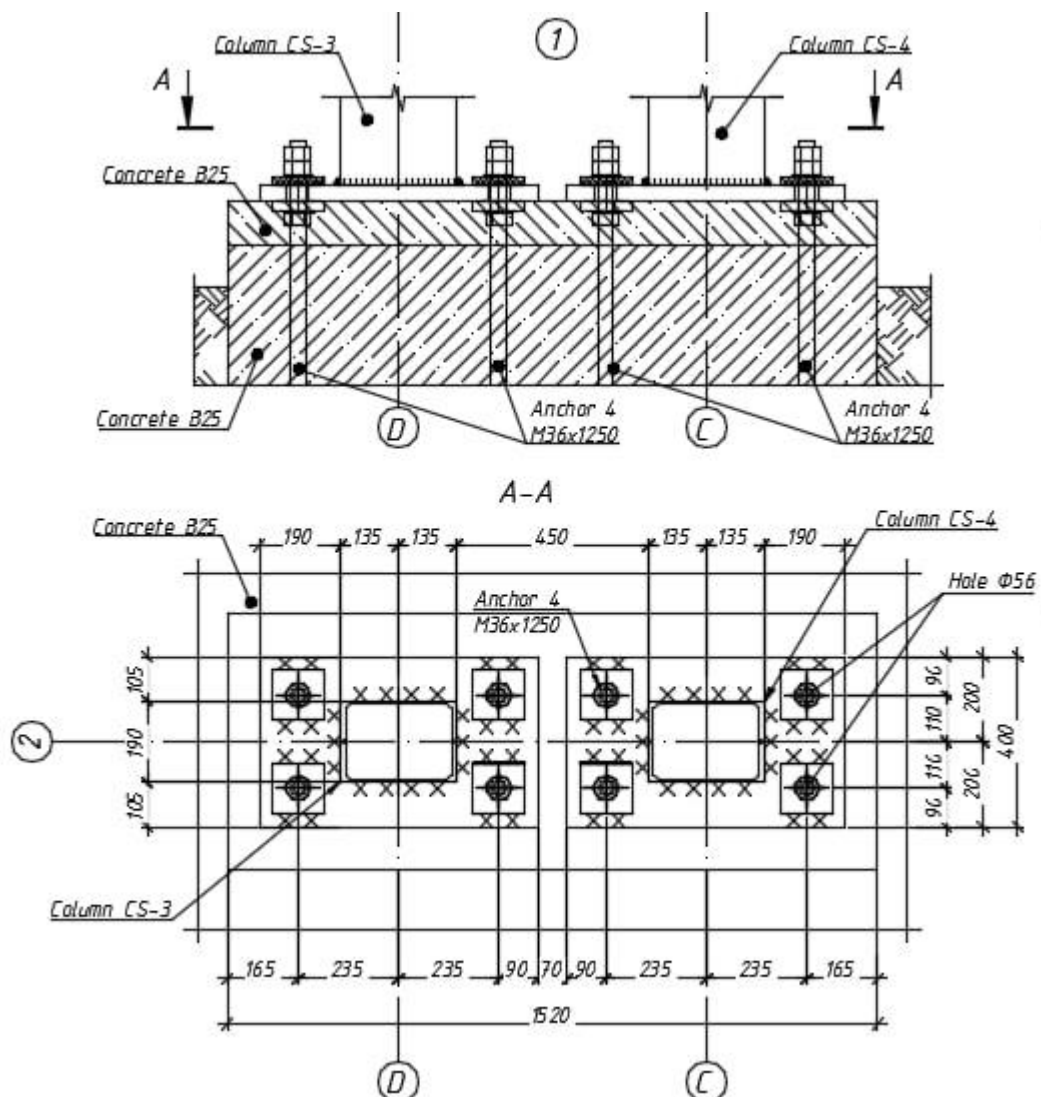

Figure 3.3 - Structural scheme of the base of the through column

### 3.5. Structural solutions of the metal frame of the building

Accordance to DBN B.1.2-14-2018 structure designed for:

- class of consequences - CC1;
- category of responsibility of structures and their elements - A;
- service life - 100 years.

Loads on structures are accepted according to DBN ДБН В.1.2-2:2006 «Навантаження і впливи» [25 ]and architectural decisions.

Description of the building and its calculation scheme

Structural scheme of the building - frame. The sport arena of weightlifting gym consists of two span system building with two different heights, who perceive the influences acting on them and transfer the efforts arising at the same time to the foundations. The division of the building into two separate frames is due to the difference in height, which in the case of a solid frame would cause the action of significant bending moments on the middle (joint) column. For the middle part of the building (in the place of height difference) the foundations under the columns of both frames are common for the extreme columns (as well as half-timbered) in separate separated foundations for each frame. The basis of the frames are transverse frames, which are formed by columns and crossbars, presented in the form of trusses, the step of the frames is 6 m, the span of trusses is conventionally 12 m, the truss panel is 3 m along the lower belt and 1.5 m along the upper. The connection of the frames to the foundation is hinged. The connection of the crossbars with the columns is rigid (the connection of the lower and upper belts of the trusses to the columns is hinged). On the transverse frames are hinged according to the split scheme located in the longitudinal direction of the run beams, the support of the beams on the upper belts of the trusses is accepted at the intersection of the racks and struts with the belt. The rigidity and geometric invariance of the frame in the transverse direction is provided by the frames, in the longitudinal - by the systems of braces on the pavement and columns. The system

of cover braces includes: braces on the lower and upper belts of trusses, ligaments between trusses, struts between the lower belts of trusses, runs (as struts between the upper belts of trusses) and struts with braces on them (all connections for the system of braces on the coating are hinged). Column brace system includes: vertical braces and struts between columns (all connections for column brace system are hinged).

Enclosing structures are attached to the frame elements, which are presented in the form of sandwich panels. To maintain the wall fencing, half-timbered columns are provided, and windows, doors and gates are equipped with wall frame elements. It is also planned to install metal supporting structures on the lower belt of the trusses.

Steel structures are made of rolled steel grade C245. All steel structures must be covered with corrosion protection.

The following cross-sections of load-bearing elements are used:

- main columns - 2 channels №27II (box section);
- half-timbered columns - square steel profile tube 140x4;
- chord - square steel profile tube 120x4;
- racks and struts of trusses - square steel profile tube 80x4;
- supporting struts of trusses - square steel profile tube 100x4;
- struts on columns and bottom chord of truss - square steel profile tube 80x4;
- vertical brace between columns and trusses - square steel profile tube 100x4; 60x4;
- horizontal brace on chord of truss - 120x4 square pipe;
- purlins of cover - channels №24 II;
- spacers between the purlins - square steel profile tube 40x4;
- brace on the spacers of purlins - square steel profile tube 80x4.

All materials used in the project are domestically produced or certified in Ukraine.



## Determination of load acting on the frame

Determination of loads is performed in accordance with ДБН В.1.2-2:2006 «Навантаження і впливи».

Table 3.3.

### Calculation of service and limit rating loads applied to the frame

№	Name	Service rating load $g_{\text{хар}}, \text{T/M}^2$	$\gamma_{fe}$	Operational rating load $g_e, \text{T/M}^2$	$\gamma_{fm}$	Limit rating load $g_{rp}, \text{T/M}^2$
1	2	3	4	5	6	7
Constant load						
Load on $1\text{m}^2$						
1	Own weight of structures	is determined automatically by the software package from $\gamma_{fm}=1,05$ – for metal structures				
2	Roofing sandwich panel	0,37	1	0,37	1,3	0,48
3	Ceiling, equipment and supporting structures	1,00	1	100	1,3	1,30
4	Wall sandwich panels with window filling and wall frame elements	2,00	1	2,00	1,3	2,6
Changeable loads						
Load on $1\text{m}^2$						
5	Snow load	1,55	0,49	0,76	1,14	1,77
6	Wind load	BeCT	1	BeCT	1,14	BeCT

Assignment reliability factor for buildings class of consequences CC1 and constructions of consequences categories A  $\gamma_n=1,00$  - for the first group limit states and  $\gamma_n=0,95$  - for the second.

Snow and wind loads for the sport arena of weightlifting gym were determined using the satellite of the BeCT settlement complex SCAD Office. When



determining the snow load, the loads from the formation of snow bags in the places of installation of parapets and the difference in height of parts of the building were also taken into account. The wind load on the roof was not taken into account during the calculation, as it unloads the structures.

### Snow load

Table 3.4.

The calculation was made according to the design standards "DBN B.1.2-2:2006 with change No. 1"

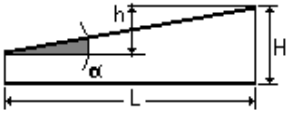
Parameter	Values	Units
Locality		
Characteristic value of snow load	0.155	t/m <sup>2</sup>
The height of the construction object above sea level	0.18	km
Building		
		
Building height H	9	m
Building width B	18	m
h	2.5	m
α	11.768	deg
L	12	m
Non-insulated design with increased heat dissipation	Not	
Reliability coefficient for the limit reporting meeting $\gamma_{fm}$	1.14	
Reliability factor according to the operational design value $\gamma_{fe}$	0.49	

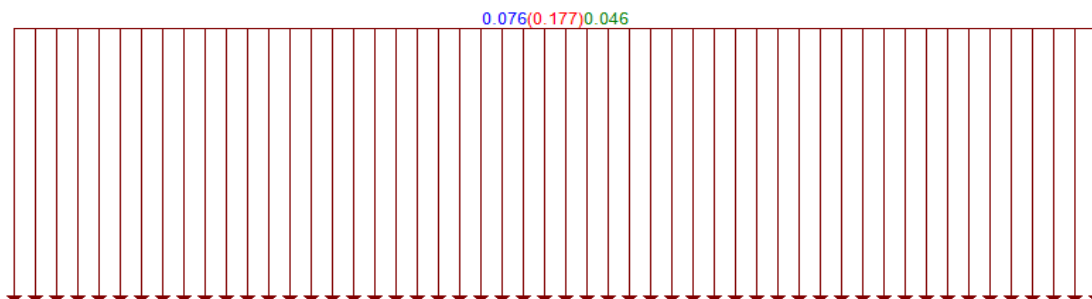

Units: T/m<sup>2</sup>

— Operational value

— Limit value

— Quasi-constant value

The report was generated by the BeCT program.

### Snow load

Table 3.5.

The calculation was made according to the design standards "DBN B.1.2-2:2006 with change No. 1"

Parameter	Values	Units
Locality		
Characteristic value of snow load	0.155	T/m <sup>2</sup>
The height of the construction object above sea level	0.18	km
Building		
		
Building width B	18	m
h	0.9	m
Non-insulated design with increased heat dissipation	Not	
Reliability coefficient for the limit reporting meeting $\gamma_{fm}$	1.14	
Reliability factor according to the operational design value $\gamma_{fe}$	0.49	

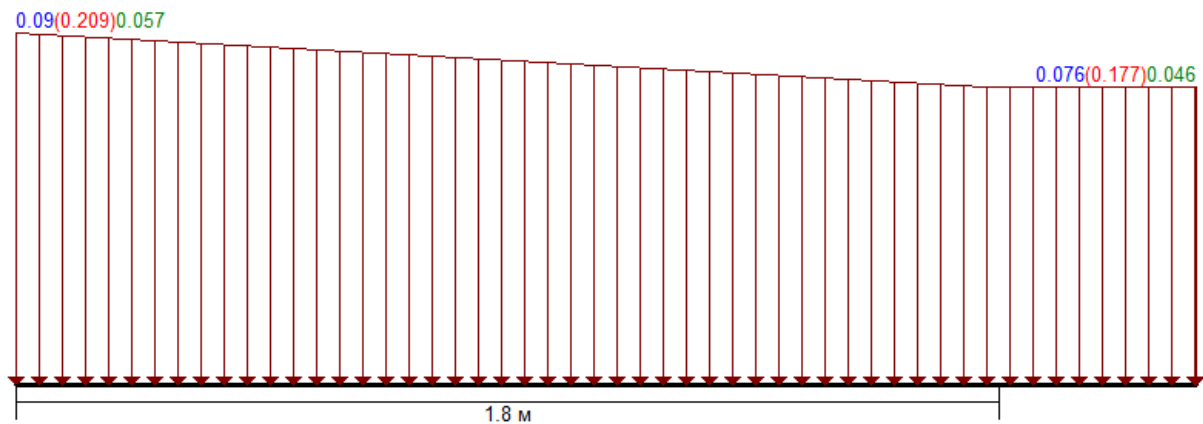

Units: T/m<sup>2</sup>

— Operational value

— Limit value

— Quasi-constant value

The report was generated by the BeCT program.

### Snow load. Buildings with height differences

Table 3.6.

The calculation was made according to the design standards  
"DBN B.1.2-2:2006 with change No. 1"

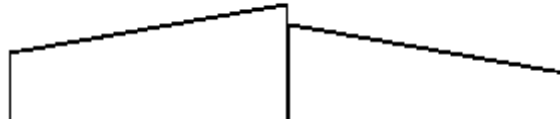

Parameter	Values	Units
Locality		
Characteristic value of snow load	0.155	T/m <sup>2</sup>
The height of the construction object above sea level	0.18	km
Building height H	9	m
Building width B	18	m
h	2.5	m
$\alpha$	11.768	deg
L	12	m
Non-insulated design with increased heat dissipation	Not	
Reliability coefficient for the limit reporting meeting $\alpha_{fm}$	1.14	
Reliability factor according to the operational design value $\alpha_{fe}$	0.49	
Right building		
Building height H	6.3	m
Building width B	18	m
h	2.5	m
$\alpha$	11.768	deg
L	12	m
Non-insulated design with increased heat dissipation	Not	
Reliability coefficient for the	1.14	

Parameter	Values	Units
limit reporting meeting $\square_{fm}$		
Reliability factor according to the operational design value $\square_{fe}$	0.49	
Height difference	2.7	m

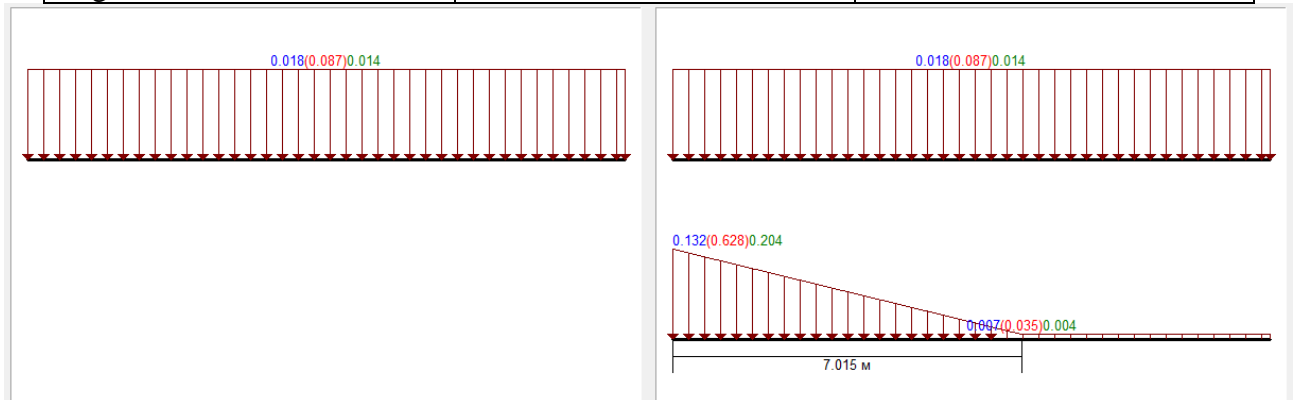

Units: T/m<sup>2</sup>

- Operational value
- Limit value
- Quasi-constant value

The report was generated by the BeCT program.

### Wind load

*Table 3.7.*

The calculation was performed according to the design standards "DBN V.1.2-2:2006 with change No. 1"

Initial data	
Characteristic value of wind pressure	0.04 T/m <sup>2</sup>
Locality type	II - rural area with fences (fences), small structures, houses and trees
Structure type	Single-span buildings without streetlights
The height of the construction object above sea level	0.18 km

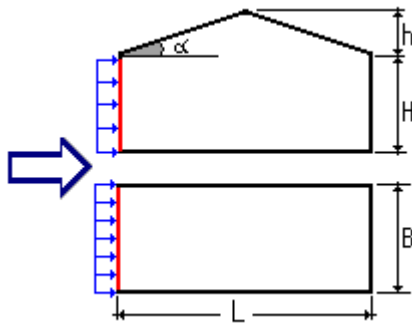

Parameters		
Surface	Left side	
Scan step	1 m	
Safety factor according to the design limit $\gamma_{fm}$	1.14	
Safety factor according to the operational design value $\gamma_{fe}$	0.21	
H	10	m
B	18	m
h	2.5	m
L	24	m

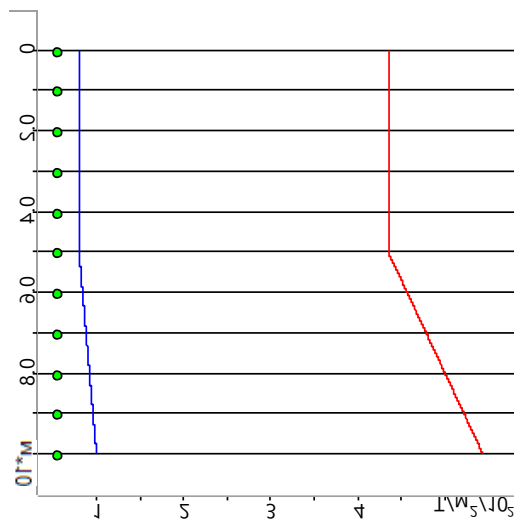

Height (m)	Operating value (T/m <sup>2</sup> )	Limit value (T/m <sup>2</sup> )
0	0.008	0.044
1	0.008	0.044
2	0.008	0.044
3	0.008	0.044
4	0.008	0.044
5	0.008	0.044
6	0.008	0.046
7	0.009	0.048
8	0.009	0.05
9	0.01	0.052
10	0.01	0.054

The report was generated by the BeCT program.

## Wind load

Table 3.8.

The calculation was performed according to the design standards "DBN V.1.2-2:2006 with change No. 1"

Initial data	
Characteristic value of wind pressure	0.04 T/m <sup>2</sup>
Locality type	II - rural area with fences (fences), small structures, houses and trees
Structure type	Single-span buildings without streetlights
The height of the construction object above sea level	0.18 km

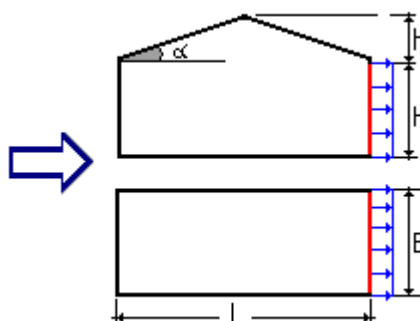

Parameters		
Surface	Right side	
Scan step	1 m	
Safety factor according to the design limit $\gamma_{fm}$	1.14	
Safety factor according to the operational design value $\gamma_{fe}$	0.21	
H	10	m
B	18	m
h	2.5	m
L	24	m

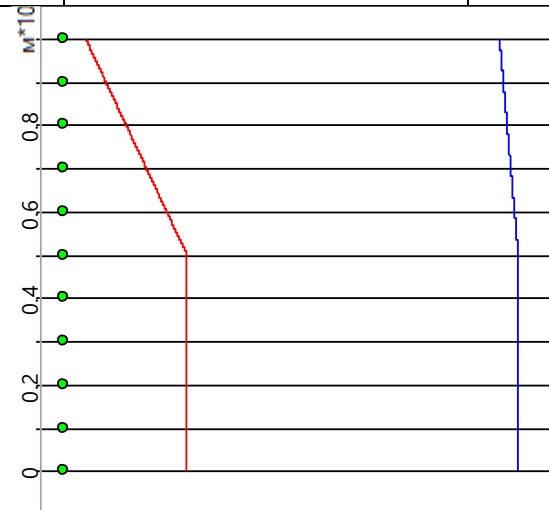

Height (m)	Operating value (T/m <sup>2</sup> )	Limit value (T/m <sup>2</sup> )
0	-0.004	-0.022
1	-0.004	-0.022
2	-0.004	-0.022
3	-0.004	-0.022
4	-0.004	-0.022
5	-0.004	-0.022
6	-0.004	-0.023
7	-0.004	-0.024
8	-0.005	-0.025
9	-0.005	-0.026
10	-0.005	-0.027

The report was generated by the BeCT program.

### Wind load

Table 3.9.

The calculation was performed according to the design standards "DBN V.1.2-2:2006 with change No. 1"

Initial data	
Characteristic value of wind pressure	0.04 T/m <sup>2</sup>
Locality type	II - rural area with fences (fences), small

Initial data	
	structures, houses and trees
Structure type	Single-span buildings without streetlights
The height of the construction object above sea level	0.18 km

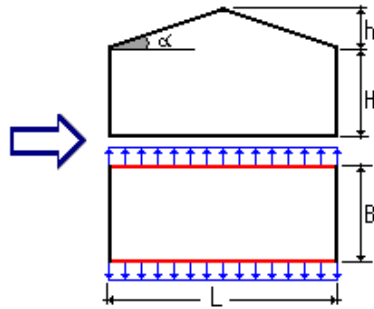

Parameters		
Surface	Side walls	
Scan step	1 m	
Safety factor according to the design limit $\square_{fm}$	1.14	
Safety factor according to the operational design value $\square_{fe}$	0.21	
H	10	m
B	18	m
h	2.5	m
L	24	m

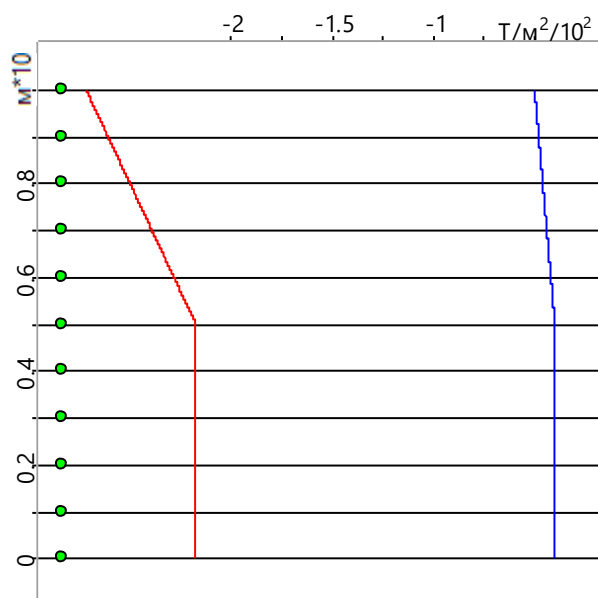

Height (m)	Operating value (T/m <sup>2</sup> )	Limit value (T/m <sup>2</sup> )
0	-0.004	-0.022
1	-0.004	-0.022
2	-0.004	-0.022
3	-0.004	-0.022
4	-0.004	-0.022
5	-0.004	-0.022
6	-0.004	-0.023



Height (m)	Operating value (T/m <sup>2</sup> )	Limit value (T/m <sup>2</sup> )
7	-0.004	-0.024
8	-0.005	-0.025
9	-0.005	-0.026
10	-0.005	-0.027

The report was generated by the BeCT program.

The following combinations of loads were used for the calculation (see table 4.1):

I) (1) · 1,0+(2) · 1,0+(3) · 1,0+(4) · 1,0+(5) · 0,9+(6a) · 0,9

II) (1) · 1,0+(2) · 1,0+(3) · 1,0+(4) · 1,0+(5) · 0,9+(6b) · 0,9,

where loads 6a and 6b are wind loads that affect the action of air from different directions.

The calculation of the frames is performed in the calculation complex SCAD Office. The calculation scheme and the results of the calculations are given below.

### 3.6. Calculation model and results of calculations

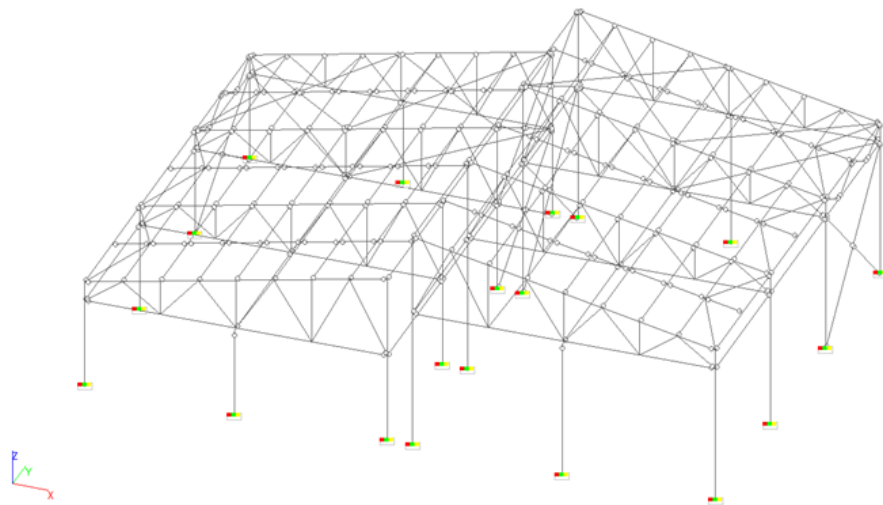

Fig. 3.4. Calculated model of frameworks

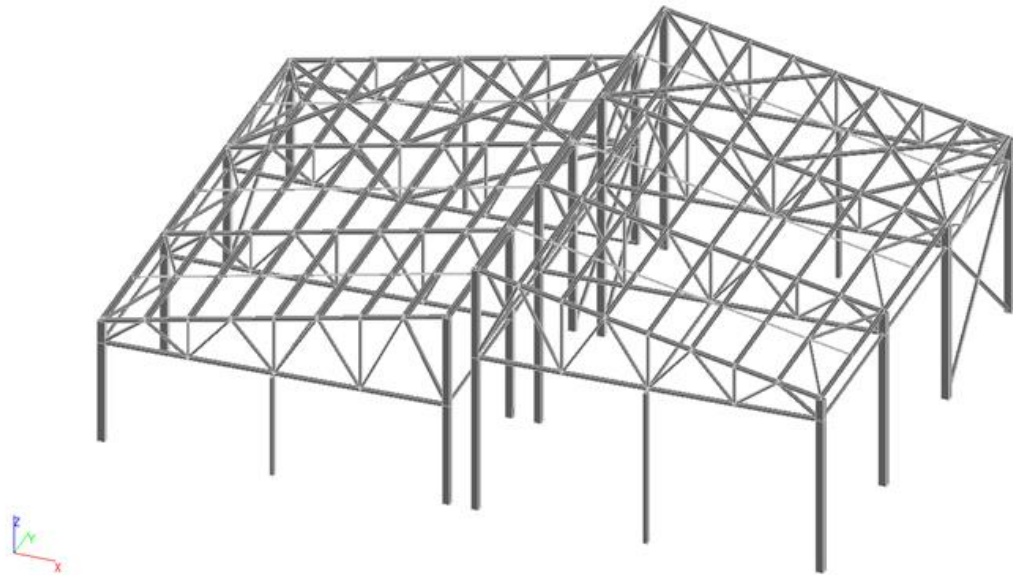

Fig. 3.5. General view of the calculation model

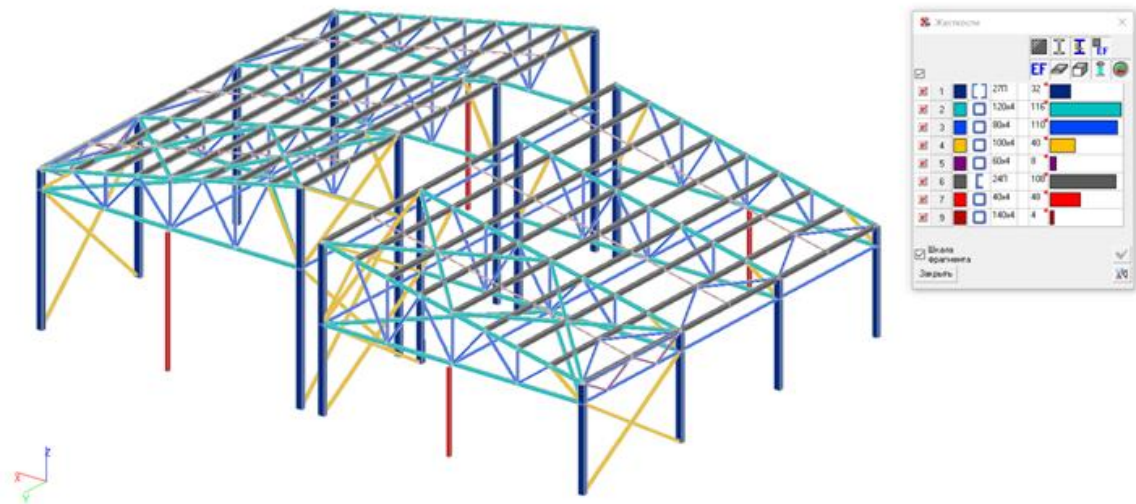
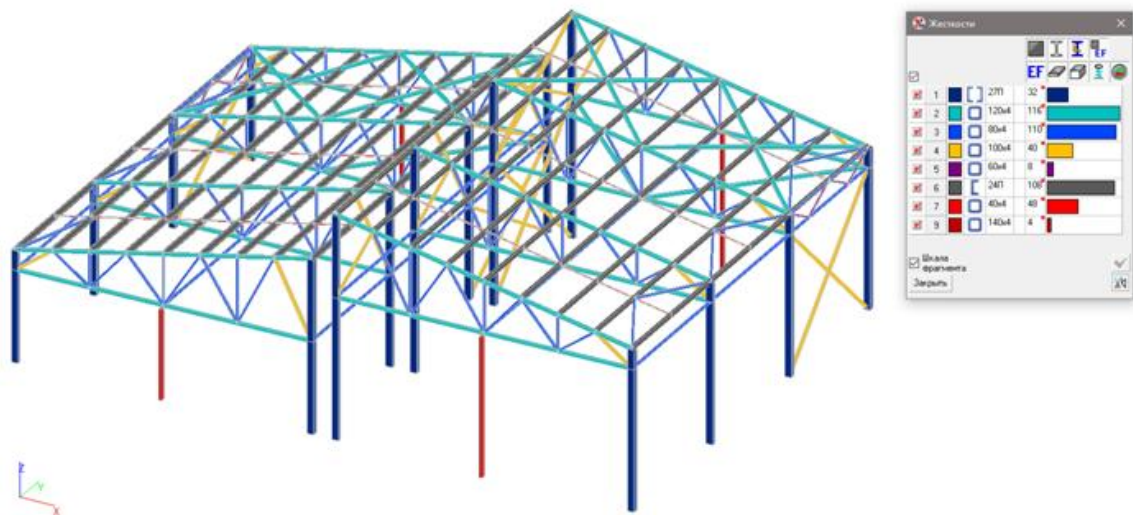

Fig. 3.6. General views of the model and rigidity of the elements

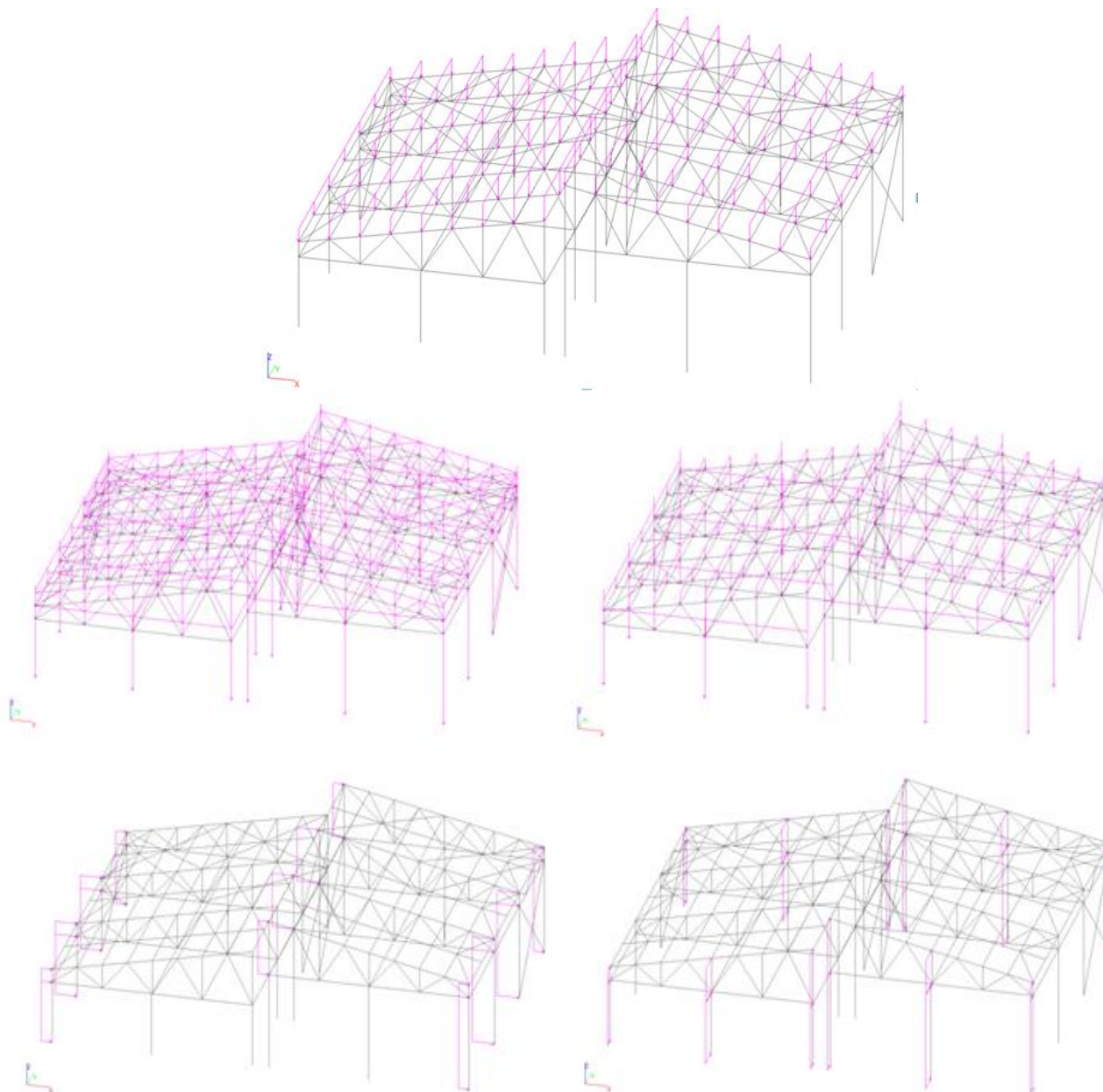

Fig. 3.7. The load of the computational model

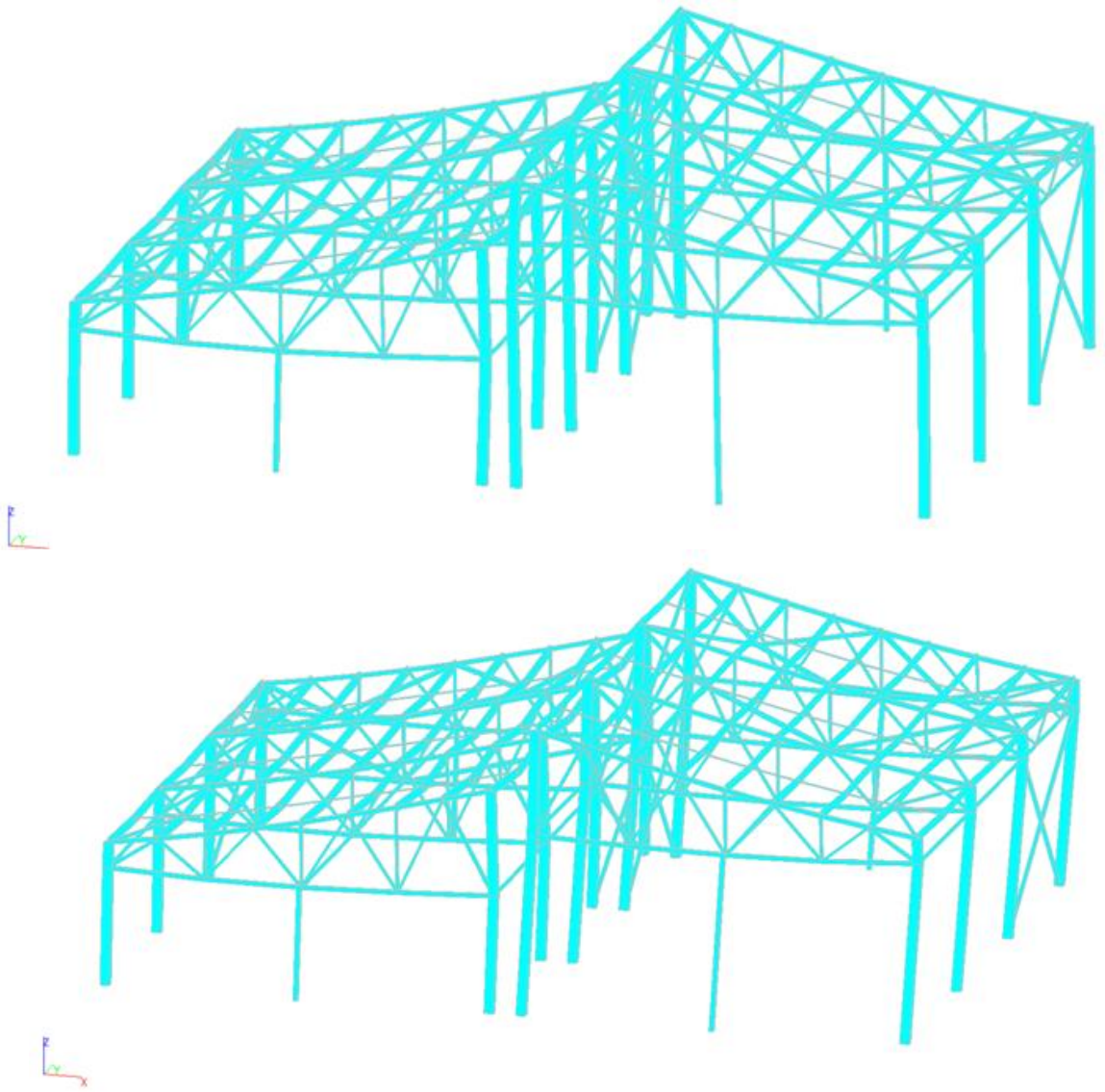

Fig. 3.8. Deformed schemes at a combination of loading



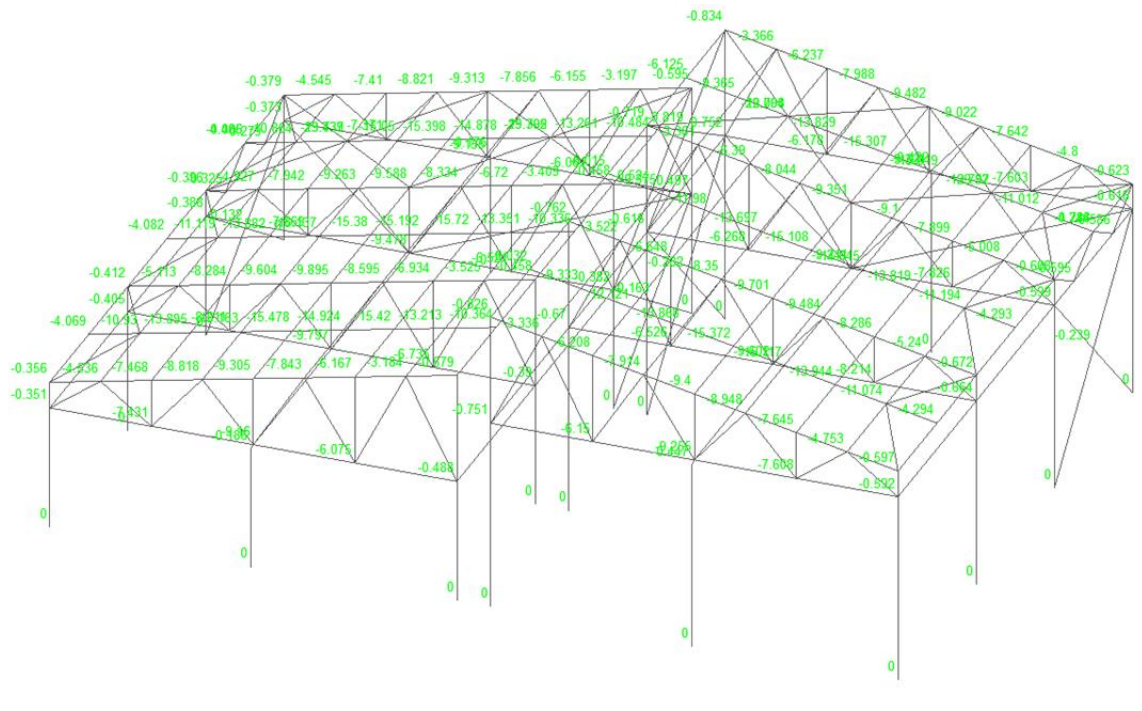

Fig. 3.9. Vertical movement of elements at the most unfavorable combination of loadings

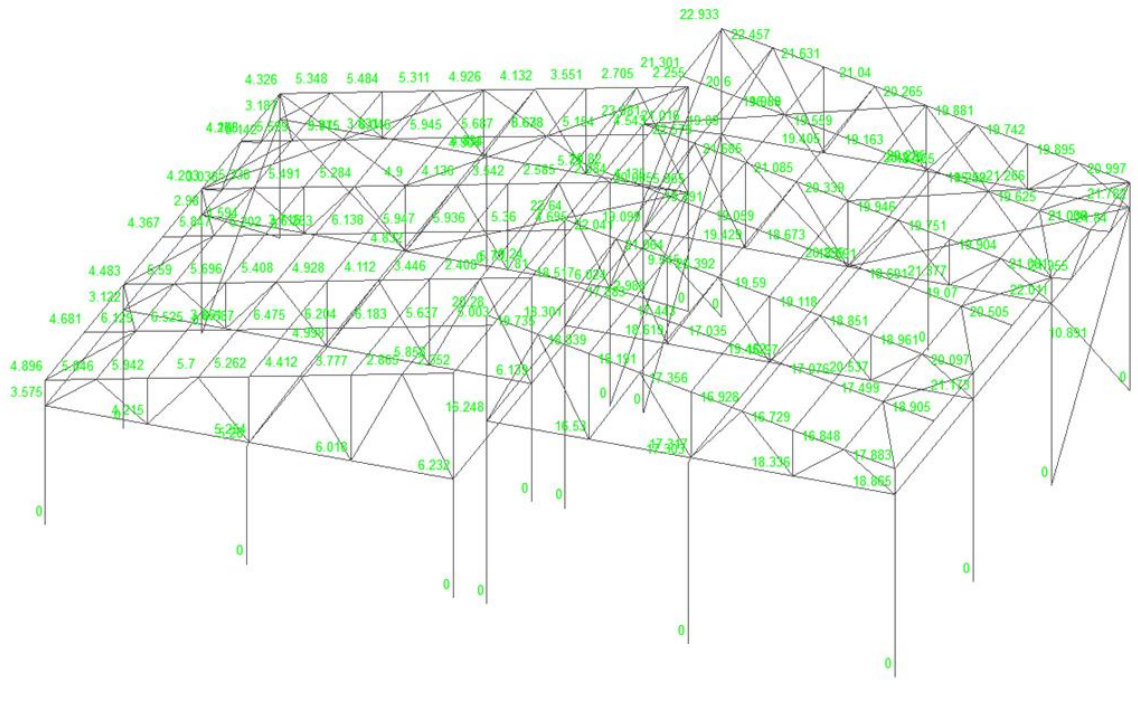

Fig. 3.10. Horizontal movements of elements on X at the most unfavorable combination of loadings

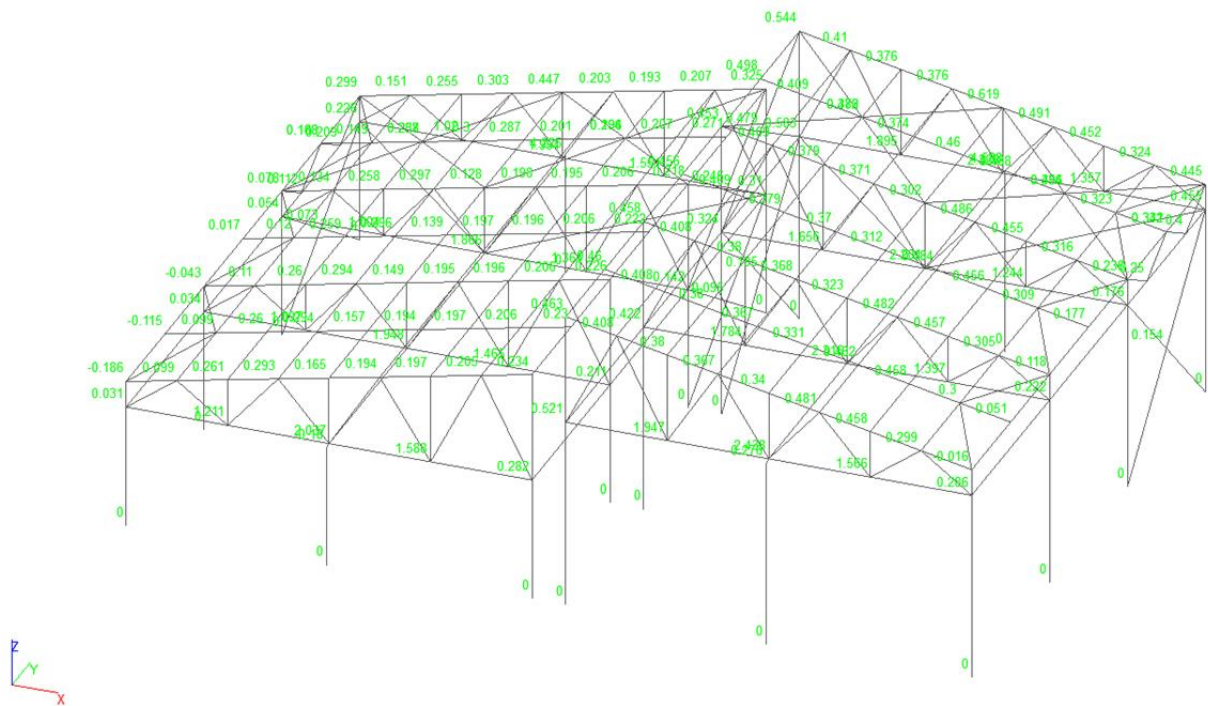

Fig. 3.11. Horizontal movement of elements on Y at the most unfavorable combination of loadings

Analyze the maximum displacements in accordance with DSTU B B.1.2-3: 2006 "Deflections and displacements":

- maximum run of the truss:
  - $9,797 \text{ mm} < 12000/250 = 48 \text{ mm}$  - therefore, the condition is met;
- maximum run of purlins:
  - $15,494 \text{ mm} < 6000/200 = 30 \text{ mm}$  - therefore, the condition is met;
- maximum deflection of horizontal braces:
  - $29,708 \text{ mm} < 8600/200 = 43 \text{ mm}$  - therefore, the condition is met;
- maximum horizontal movement of frames:
  - $23,081 \text{ mm} < 9000/200 = 45 \text{ mm}$  - therefore, the condition is met.

Therefore, the given scheme of a framework with the specified sections, materials and loadings provides durability and stability of the projected building.

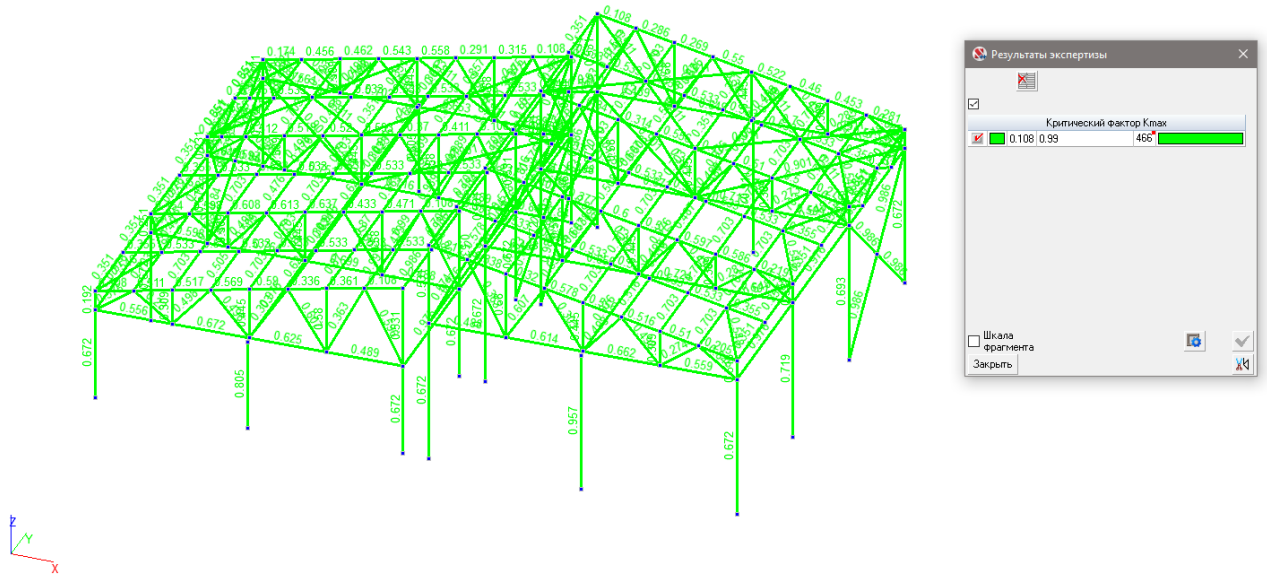

Fig. 3.12. Coefficients of using bearing capacity

## **4. Bases and Foundations**

### **4.1. Constructive solutions of the foundation**

Accordance to DBN B.1.2-14-2018 structure designed for:

- class of consequences - CC1;
- category of responsibility of structures and their elements - A;
- service life - 100 years.

Loads on structures are accepted according to DBN B.1.2-2: 2006 "Load and impact" and architectural decisions..

Description of the building and its calculation scheme

Structural scheme of the building - frame. The sport arena of weightlifting gym consists of two span system building with two different heights, who perceive the influences acting on them and transfer the efforts arising at the same time to the foundations. The division of the building into two separate frames is due to the difference in height, which in the case of a solid frame would cause the action of significant bending moments on the middle (joint) column. For the middle part of the building (in the place of height difference) the foundations under the columns of both frames are common for the extreme columns (as well as half-timbered) in separate separated foundations for each frame.

The foundations of the building are columnar monolithic reinforced concrete made of concrete class C20 / 25 (B25), W6, F200; reinforcement class A500C, A240C. The frame is hinged to the frame. Under the soles of the foundations, a 100 mm thick preparation device made of C8 / 10 concrete is provided. Along the perimeter of the building self-supporting foundation beams (section 200x1100 mm according to the split scheme, span 6 m) are arranged as enclosing structures, which rest on reinforced concrete columns (section 300x300 mm) standing on the soles of the main foundations. Concrete of foundation beams and columns of class C20 / 25 (B25), W6, F200; fittings of class A500C, A240C. Given the presence in the layers of soils with subsidence properties, the device of paving with a width of



2 m, as well as the device of drainage of water from the foundations due to vertical planning.

All materials used in the project are domestic or certified in Ukraine.

#### **4.2. Calculation of columnar monolithic reinforced concrete foundation for metal columns**

Depth of foundations is determined as a result of joint consideration of engineering and geological conditions of the construction site, design and operational features of buildings and structures, the size and nature of the load on the base, it depends on a number of factors.

According to foreign geological conditions, the depth of the foundation is determined in accordance with the peculiarities of application and properties of individual layers of the site, the depth of seasonal design and placement of soils, groundwater level and its fluctuations, the terrain. The base of the foundation should be located below the depth of seasonal freezing of soils from the house of thermal regime.

##### **Initial data**

Construction site of the sports arena of weightlifting gym. Wells № 1, 2, 3.

Well top marks:

- w. 1 = 177,05 m;
- w. 2 = 177,25 m;
- w. 3 = 177,20 m.

Current loads on the middle columns:  $N = 816.89$  kN.

The size of the cross section of the column:  $l_s = 270$  mm,  $b_s = 190$  mm.

### 4.3. Analysis of engineering and geological conditions

Table 4.1.

#### Soil characteristics

ITE	Characteristics of the engineering-geological element	Geological index	Estimated values													Sequence № of table 1 of DSTU D.2.2-1: 2012												
			Natural humidity		Humidity at the border:		The number of plasticity		Fluidity index		Density			Porosity coefficient			Water saturation coefficient		Angle of internal friction		Specific adhesion		Relative subsidence (at a pressure of 0.3 MPa)		Initial subsidence index		Deformation modulus	
			W	W <sub>L</sub>	W <sub>P</sub>	Ip	IL	ps	p	pd	e	Sr	φ	C	ξsl	Ψsl	E	Ir	Kφ	φ <sub>π</sub>	с <sub>π</sub>	ρ1	φ1	c1	α=0,85	α=0,95		
			п.о	п.о	п.о	п.о	п.о	г/сат3	г/сат3	г/сат3	п.о	п.о	г/сат3	п.о	п.о	п.о	п.о	п.о	п.о	п.о	п.о	п.о	п.о	п.о	п.о	п.о	п.о	п.о
1	Soil-vegetable layer - sandy dark gray to black, humus																										96	
2	Bulk soil - dusty sandy dark yellow, grayish-yellow with layers of sand and the inclusion of broken bricks, gravel from 5 to 50% solids	tH																	0,01								266	
3	Buried soil - heavy loam, dusty, with admixtures of organic matter, with layers of light loam, dark gray to black, solid consistency	eH	0,15	0,29	0,19	0,10	-0,14	2,69	1,94	1,69	0,59	0,67	24	33			18,00	0,057	0,05	24	33	1,85	21	22		356		
4	Loam loess light dusty dark yellow, with hints of humus has the properties of subsidence, solid consistency forecast state	vд PIII dh	0,131	0,270	0,190	0,080	-0,74	2,670	1,540	1,360	0,961	0,360	25	40	0,018	0,052	6,000	0,034	0,050	1,54	25	1,47	22	27		35B		
			0,360				2,130	1,850		1,000		1,000	16	17			3,000			1,85	16	1,76	14	11				
5	Sandy loam is light, solid plastic consistency	vд PIII dh	0,14	0,24	0,18	0,06	-0,68	2,66	1,81	1,59	0,67	0,55	22	47			20		0,5	1,81	22	1,72	19	31		366		
			0,18				0,03	1,88				0,72	20	45			18			1,88	20	1,79	17	30				
6	Sandy loam yellow, grayish-yellow solid consistency		0,06	0,15	0,12	0,03	-0,09	2,66	1,75	1,65	0,61	0,26	29	15			20		0,7	1,75	29	1,67	25	10		366		

#### 4.4. Investigation of the conditional mark $\pm 0,000$

The planned mark of the earth's surface corresponds to the absolute mark of 177.78 m. The conditional mark of  $\pm 0.000$  is the absolute mark of 177.48 m. The mark of the top of the foundation is 177.48 m or - 0.300. Foundation height  $h_f = 3.40$  m. Mark of the sole of the foundation 174.08 m.

#### 4.5. Choice of a bearing layer and a mark of a sole of the base

The first layer, or horizon, is represented by loose soils. Soil dumping was performed with layer-by-layer compaction, therefore, this horizon can be classified as dumps of dusty-clay natural soils, the estimated term of self-compaction of which is 10-15 years. Given the compaction, it can be taken as a basis for the foundation.

Load-bearing soil IGE - 5 - Sandy loam woody dusty grayish-yellow, hard and plastic consistency.

It is inexpedient to consider other layers as the first is already accepted.

The foundation sole mark is 174.08 m or -3,700.

#### 4.6. Determining the size of the foundation

Effective forces:  $N = 816.89$  kN. Accept the ratio of the sides of the base of the foundation:

$$n = l_f/b_f = 1,33$$

Conditional design resistance of solid loam soil (according to table E. of appendix E DBN B.2.1-10-2009, taking the coefficient of water saturation  $S_r = 0.8$ )

$$R_0 = 150 \text{ kPa}$$

The smaller side of the sole of the foundation

$$b_f = \sqrt{\frac{\sum N}{\eta R_0}} = \sqrt{\frac{816.89}{1.33 \cdot 150}} = 2,02m \quad (4.1)$$

Accept  $b_f = 2,4$  m.

The larger side of the sole of the foundation:

$$l_f = 2.4 \cdot 1.25 = 3,0 \text{ m}$$

For further calculations we accept  $l_f = 3,0 \text{ m}$  i  $b_f = 2,4 \text{ m}$ . Then the area of the sole of the foundation:

$$A_f = 2.4 \cdot 3,0 = 7,2 \text{ m}^2$$

Stress under the sole of the foundation:

$$p = \frac{N}{A_f} = \frac{816.89}{7.2} + 20 \cdot 3,7 = 187,45 \text{ kPa} \quad (4.2)$$

The calculated soil resistance is determined by the formula:

$$R = \frac{\gamma_{c1}\gamma_{c2}}{k} [M_\gamma k_z b \gamma'_{II} + M_q d_1 \gamma'_{II} + (M_q - 1) d_b \gamma'_{II} + M_c c_{II}], \quad (4.3)$$

where  $\gamma_{c1} = 1,25$ ;

$\gamma_{c2} = 1,0$  (according to table E.7 of appendix E DBN B.2.1-10-2009),

$k = k_z = 1,0$ ;

$b_f = 2,4 \text{ m}$ ;

angle of internal friction  $\varphi = 16$  degrees (according to table E.8 of Annex E DBN B.2.1-10-2009) where:

$$M_\gamma = 0,36,$$

$$M_q = 2,43,$$

$$M_c = 4,99.$$

Depth of laying the foundation from the planning mark:

$$d_1 = 177,78 - 174,08 = 3,7 \text{ m}.$$

The average value of the specific weight of the soil below the base of the foundation:

$$\begin{aligned} \gamma'_{II} &= \frac{\gamma_{II1} h_1 + \gamma_{II2} h_2 + \dots + \gamma_{II n} h_n}{h_1 + h_2 + \dots + h_n} = \frac{1,4 \cdot 18,1 + 0,9 \cdot 17,5}{1,4 + 0,9} \\ &= 17,87 \text{ kN/m}^3 \quad (4.4) \end{aligned}$$

The average value of the specific weight of the soil above the base of the foundation:

$$\gamma'_{II} = \frac{1 \cdot 19,4 + 1,42 \cdot 15,4}{1 + 1,42} = 17,05 \text{ kN/m}^3$$

Estimated soil resistance:

$$R = \frac{1,25 \cdot 1,0}{1,0} [0,36 \cdot 1,0 \cdot 2,4 \cdot 17,87 + 2,43 \cdot 3,7 \cdot 17,05 + 4,99 \cdot 10] \\ = 273,3 \text{ kPa}$$

$$p = 187,45 \text{ kPa} < R = 273,3 \text{ kPa}.$$

Then the pressure under the sole of the foundation, taking into account the weight of the foundation and the justification for its ledges, will be:

$$G = 2,4 \cdot 3,0 \cdot 3,7 \cdot 40 = 1065,6 \text{ kN},$$

$$\Sigma N = 816,89 + 1065,6 = 1882,49 \text{ kN}.$$

$$p = \frac{N}{A_f} = \frac{1882,49}{7.2} = 261,46 \text{ kPa} \quad (4.5)$$

Estimated soil resistance:

$$R = \frac{1,25 \cdot 1,0}{1,0} [0,36 \cdot 1,0 \cdot 2,4 \cdot 17,87 + 2,43 \cdot 3,7 \cdot 17,05 + 4,99 \cdot 10] \\ = 273,3 \text{ kPa}$$

The value of  $p = 261.46 \text{ kPa}$  is less by 4.33% from  $R = 273.3 \text{ kPa}$ , which is within the tolerance of 5% .

Accept  $l_f = 3,0 \text{ m}$  and  $b_f = 2,4 \text{ m}$ .

#### 4.7. Determination of the sizes of the base and constructive calculation

Concrete class C20 / 25 (B25); reinforcement class A500C.

The volume of concrete foundation

$$V_b = 0,35 \cdot 2,4 \cdot 3,0 + 2,9 \cdot 0,6 \cdot 1,4 + (0,3 \cdot 0,3 \cdot 2) \cdot 2 = 5,32 \text{ m}^3.$$

The required area of reinforcement of the slab part of the foundation is determined in the direction of the moment, ie along the larger side.

$$p_{\max} = 261,46 \cdot 2,4 = 627,5 \text{ kPa}; p_I = 261,46 \text{ kPa}; p_{II} = 261,46 \text{ kPa}$$

The moment acting at the intersection at the boundary of the column and the step:

$$M_{I-1} = \frac{261,46 \cdot 2,4 \cdot 0,35^2}{2} + \frac{(627,5 - 261,46) \cdot 0,35 \cdot 2,4}{2} \cdot \frac{2}{3} \cdot 0,35 \\ = 74,3 \text{ kNm}$$

The required area of reinforcement is determined by two sections:

$$A_{s1} = \frac{743\,000}{0,9 \cdot 26 \cdot 5000} = 6,35 \text{ cm}^2$$

With such a cross-sectional area of the reinforcement, the reinforcement coefficient  $\mu = 0.1\%$ , which is insufficient at a rate of  $0.5\%$ .

The required area of reinforcement of the slab part of the foundation is determined by the direction of the moment, ie along the shorter side.

$$p_{\max} = 261,46 \cdot 2,4 = 627,5 \text{ kPa}; p_I = 261,46 \text{ kPa}; p_{II} = 261,46 \text{ kPa}$$

The moment acting at the intersection at the boundary of the column and the step:

$$M_{I-1} = \frac{261,46 \cdot 3,0 \cdot 0,35^2}{2} = 48,04 \text{ kNm}$$

The required area of reinforcement is determined by two sections:

$$A_{s1} = \frac{480\,400}{0,9 \cdot 26 \cdot 5000} = 4,1 \text{ cm}^2$$

With such a simple reinforcement cross section, the reinforcement coefficient  $\mu = 0.05\%$ , which is insufficient at a rate of  $0.5\%$ , so we find the required cross-sectional area of the reinforcement to achieve a reinforcement value of  $0.5\%$ :

$$\text{for } b_f = 2,4 \text{ m, } A_s = 31,2 \text{ cm}^2,$$

$$\text{for } l_f = 3,0 \text{ m, } A_s = 39 \text{ cm}^2.$$

Accept:

for  $b_f = 2,4 \text{ m}$  - 12Ø16 A500C with a total area  $A_s = 40,2 \text{ cm}^2$ , step rods 200mm, length 2350 mm.

for  $l_f = 3,0 \text{ m}$  - 17Ø16 A500C with a total area  $A_s = 40,2 \text{ cm}^2$ , step rods 200mm, length 2950 mm.

Rebar waste is taken into account by a factor  $k = 1,05$ .

Consumption of fittings for the grid C-1:

$$\Sigma G_{s10} = (12 \cdot 2,35 \cdot 1,58 + 17 \cdot 2,95 \cdot 1,58) \cdot 1,05 = 129,98 \text{ kg.}$$

#### 4.8. Collection of loads and calculation on the foundations

The basis for the foundations is IGE-5 - sandy woody dusty grayish-yellow, hard and plastic consistency. Absolute mark of the sole of the foundations 174,080 (excluding concrete preparation), relative -3,700. The height of the foundations is 3.4 m. The minimum depth of laying the foundation (according to vertical planning) is 3.1 m. Collection of loads on building frames is performed in accordance with DBN B.1.2-2:2006 "Loads and impacts". Assignment reliability factor for the building of responsibility class CC1 and structures of responsibility category  $\gamma_n=1,00$  - for the first group of boundary conditions and  $\gamma_n=0,95$  - for the second. The maximum calculated values of loads on the edges of the foundations were adopted based on the results of the calculation of frames. Thus, the maximum design loads on the foundation:

- extremecolumn:

$N_k = 30 \text{ t}$  – vertical load from the column;

$Q_k = 3,5 \text{ t}$  – maximum horizontal load from the column in both planes;

$M_k = Q_k \times 3,4 \text{ m} = 3,5 \text{ t} \times 3,4 \text{ m} = 11,9 \text{ t} \times \text{m}$  – maximum bending moment from the action of horizontal load on the edge of the foundation in both planes;

$N_{k\sigma} = 4,7 \text{ t}$  – vertical load from columns and foundation beams;

$N_{kII} = 7 \text{ t}$  – vertical load from the floor structure and payload of  $1 \text{ t/m}^2$  above the base of the foundation.

$N_{ky}, \text{ t}$  – vertical load from the own weight of the foundation and the weight of the soil on its ledges (determined automatically by the satellite REQUEST of the settlement complex SCAD Office);

$N_{ck} = N_k + N_{k\sigma} + N_{kII} = 30 \text{ t} + 4,7 + 7 \text{ t} = 41,7 \text{ t}$  – total vertical load on the foundation of the extreme column without taking into account the own weight of the foundation and the weight of the soil on its ledges (for calculation in the satellite REQUEST of the settlement complex SCAD Office);

- middlecolumns:

$N_c = 66 \text{ t}$  – vertical load from the columns;

$Q_{c1} = 2 \text{ t}$  – horizontal load from the columns in the plane of the frame;

$Q_{c2} = 7 \text{ t}$  – horizontal load from the columns from the plane of the frame;

$M_{c1} = Q_{c1} \times 3,4 \text{ m} = 2 \text{ t} \times 3,4 \text{ m} = 6,8 \text{ t}\cdot\text{m}$  – bending moment from the action of horizontal load on the edge of the foundation in the plane of the frame;

$M_{c2} = Q_{c2} \times 3,4 \text{ m} = 7 \text{ t} \times 3,4 \text{ m} = 23,8 \text{ t}\cdot\text{m}$  – bending moment from the action of horizontal load on the edge of the foundation from the plane of the frame;

$N_{c\phi} = 4,7 \text{ t}$  – vertical load from columns and foundation beams;

$N_{c\pi} = 12,6 \text{ t}$  – vertical load from the floor structure and payload of  $1 \text{ t}/\text{m}^2$  above the base of the foundation.

$N_{cy}, \text{ t}$  – vertical load from the own weight of the foundation and the weight of the soil on its ledges (determined automatically by the satellite REQUEST of the settlement complex SCAD Office).

$N_{cc} = N_{c+} + N_{c\phi} + N_{c\pi} = 66 \text{ t} + 4,7 + 12,6 \text{ t} = 83,3 \text{ t}$  – total vertical load on the foundation of the middle columns without taking into account the own weight of the foundation and the weight of the soil on its ledges (for calculation in the satellite REQUEST of the settlement complex SCAD Office);

- half-timbered column:

$N_{\phi} = 11 \text{ t}$  – vertical load from the column;

$Q_{\phi} = 1 \text{ t}$  – horizontal load from the column in the plane of the frame (there is no horizontal load from the plane of the frame);

$M_{\phi} = Q_{\phi} \times 3,4 \text{ m} = 1 \text{ t} \times 3,4 \text{ m} = 3,4 \text{ t}\cdot\text{m}$  – bending moment from the action of horizontal load on the edge of the foundation;

$N_{\phi\phi} = 4,7 \text{ t}$  – vertical load from columns and foundation beams;

$N_{\phi\pi} = 3,2 \text{ t}$  – vertical load from the floor structure and payload of  $1 \text{ t}/\text{m}^2$  above the base of the foundation.

$N_{\phi y}, \text{ t}$  – vertical load from the own weight of the foundation and the weight of the soil on its ledges (determined automatically by the satellite REQUEST of the settlement complex SCAD Office);

$N_{\phi c} = N_{\phi+} + N_{\phi\phi} + N_{\phi\pi} = 11 \text{ t} + 4,7 + 3,2 \text{ t} = 18,9 \text{ t}$  – total vertical load on the foundation of the half-timbered column without taking into account the own weight of the foundation and the weight of the soil on its ledges (for calculation in



the satellite REQUEST of the settlement complex SCAD Office). The following sizes (in the plan) of the bases are accepted:

- extremecolumn:

subcolumn - 600x600 mm; sole 2000x2000 mm; sole thickness 500 mm;

- middle columns:

subcolumn - 600x1400 mm; sole 2400x3000 mm; sole thickness 500 mm

- half-timbered column:

subcolumn - 500x600 mm; sole 1200x1500 mm; sole thickness 350 mm.

Determination of the calculated resistance of the soil, the average pressure on the soles of the foundations and their subsidence were calculated using the satellite REQUEST of the calculation complex SCAD Office. The results of the calculation in the satellite and the verification of the marginal stresses are given below.

#### 4.8.1. Sediment of the foundation of extreme column

Calculation Performed according to DBNB.2.1-10-2018

Foundation under consideration

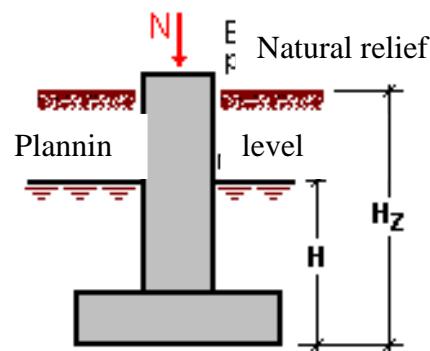

Depth of the sole of the foundation from the level of planning, H 3.1 m

Depth of foundation footing relative to natural high relief, Hz 3.1 m

Limit value of foundation deformation 100 mm

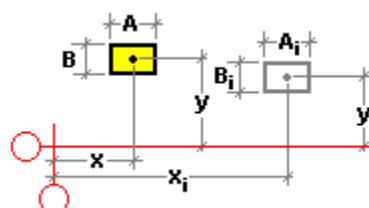

Table 4.1

## Initial data

Center coordinates		Sole sizes		Longitudinal force
X	Y	A	B	N
m	m	m	m	T
0	0	2	2	41.7

## Soils

Ground safety factor  $\gamma_g = 1$

Average specific gravity of the soil above the sole of the foundation  $1.65 \text{ T/m}^3$

Table 4.2

## The soil above the sole of the foundation

	Name	Layer thickness m	Specific gravity $\text{T/m}^3$	Specific cohesion $\text{T/m}^2$	Angle of internal friction degrees	Deformation modulus $\text{T/m}^2$	Availability of water	Porosity coefficient	Working condition coefficients		Consider pore pressure
									grounds	foundation	
1	IIE-5	1.5	1.88	3	17	1800	+	0.674	1.25	1	
2	IIE-6	0.5	1.75	1	25	2000	+	0.61	1.25	1	
3	IIE-5	0.6	1.88	3	17	1800	+	0.674	1.25	1	

Table 4.3

## Calculation results

The check for the level of the sole is satisfied		
Estimated soil resistance at the level of the base of the foundation	36.263	$\text{T/m}^2$
Mean pressure from loads (including the vestibule of the foundation, soil and floor) at the level of the base of the foundation	16.625	$\text{T/m}^2$
The draft is determined for the base in the form of an elastic half-space		
Foundation settlement	14.199	mm
Load drawdown	0	mm
Settling from the weight of the soil	0	mm
Sum of draft and drawdown	14.199	mm
Depth of compressible thickness	5.2	m
Winkler bed coefficient	1170.862	$\text{T/m}^3$

Table 4.4

## Ground layer data

	Layer thickness	Load pressure at the midpoint of the layer	Domestic pressure at the midpoint of the layer	Design pressure at the roof level of heterogeneous soil layers	Draft	Drawdown
	m	T/m <sup>2</sup>	T/m <sup>2</sup>	T/m <sup>2</sup>	mm	mm
1	0.8	14.963	5.325	0	5.647	0
2	0.7	10.709	5.72	0	3.537	0
3	0.5	6.852	6.02	39.917	1.455	0
4	0.8	4.464	6.347	39.897	1.685	0
5	0.8	2.76	6.767	0	1.042	0
6	0.8	1.845	7.188	0	0.697	0
7	0.8	1.313	7.608	0	0.137	0

The report was generated by the REQUEST program.

Maximum pressure under the sole of the foundation under the extreme column:  $p_{\max} = p_{mt} + \frac{M_{\kappa}}{W} = 16,625 + \frac{11,9}{1,333} = 25,6(t/m2) < 1,2 \times 36,263 = 43,5(t/m2)$ .

Minimum pressure under the sole of the foundation under the extreme column:  $p_{\min} = p_{mt} - \frac{M_{\kappa}}{W} = 16,625 - \frac{11,9}{1,333} = 7,7(t/m2) > 0$ .

Therefore, the accepted dimensions satisfy the conditions and are accepted for further calculation of deformations.

We compare the calculated value of sedimentation with the limit value:  $s = 14,199 \text{ mm} < s_u = 100 \text{ mm}$ .

Therefore, the accepted dimensions of the foundation under the extreme column satisfy the conditions and are final.

#### 4.8.2. Sediment of the foundation of middle column

Calculation performed according to DBNB.2.1-10-2018

Foundation under consideration

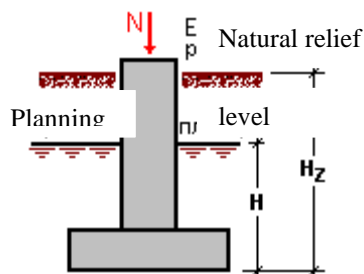

Depth of the sole of the foundation from the level of planning, H 3.1 m

Depth of foundation footing relative to natural high relief, Hz 3.1 m

Limit value of foundation deformation 100 mm

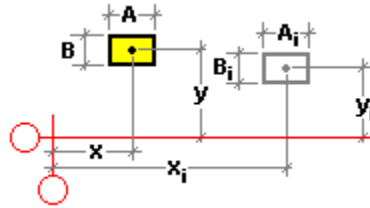

Table 4.5

Initial data

Center coordinates		Sole sizes		Longitudinal force
X	Y	A	B	N
m	m	m	m	T
0	0	2.4	3	83.3

Soils

Ground Safety Factor  $\gamma_g = 1$

Average specific gravity of the soil above the sole of the foundation 1.65 T/m<sup>3</sup>

Table 4.6

The soil above the sole of the foundation

	Name	Layer Thickness	Specific gravity	Specific Cohesion	Angle of Internal Friction	Deformation modulus	Availability of water	Porosity coefficient	Working condition coefficients		Consider pore pressure
									grounds	foundation	
		m	T/m <sup>3</sup>	T/m <sup>2</sup>	degrees	T/m <sup>2</sup>					
1	IIE-5	1.5	1.88	3	17	1800	+	0.674	1.25	1	
2	IIE-6	0.5	1.75	1	25	2000	+	0.61	1.25	1	
3	IIE-5	0.6	1.88	3	17	1800	+	0.674	1.25	1	

Table 4.7

Calculation results

The check for the level of the sole is satisfied		
Estimated soil resistance at the level of the base of the foundation	36.367	T/m <sup>2</sup>
Mean pressure from loads (including the vestibule of the foundation, soil and floor) at the level of the base of the foundation	17.769	T/m <sup>2</sup>
The draft is determined for the base in the form of an elastic half-space		
Foundation settlement	20.014	mm
Load drawdown	0	mm
Settling from the weight of the soil	0	mm
Sum of draft and drawdown	20.014	mm
Depth of compressible thickness	6.8	m

Winkler bed coefficient	887.866	T/m <sup>3</sup>
-------------------------	---------	------------------

Table 4.8

Ground layer data

	Layer thickness	Load pressure at the midpoint of the layer	Domestic pressure at the midpoint of the layer	Design pressure at the roof level of heterogeneous soil layers	Draft	Drawdown
	m	T/m <sup>2</sup>	T/m <sup>2</sup>	T/m <sup>2</sup>	mm	mm
1	0.96	16.259	5.367	0	7.337	0
2	0.54	13.011	5.762	0	3.302	0
3	0.5	9.915	6.02	40.013	2.097	0
4	0.96	6.848	6.389	39.929	3.09	0
5	0.96	4.219	6.893	0	1.904	0
6	0.96	2.784	7.398	0	1.256	0
7	0.96	1.956	7.903	0	0.883	0
8	0.96	1.441	8.407	0	0.145	0

The report was generated by the REQUEST program.

Maximum pressure under the sole of the foundation under the middle columns in the plane of the frames:

$$p_{\max 1} = p_{mt} + \frac{M_{c1}}{W} = 17,769 + \frac{6,8}{3,6} = 19,7(t/m2) < 1,2 \times 36,367 = 43,6(t/m2).$$

Maximum pressure under the sole of the foundation under the middle columns from the plane of the frames:

$$p_{\max 2} = p_{mt} + \frac{M_{c2}}{W} = 17,769 + \frac{23,8}{2,88} = 26,03(t/m2) < 1,2 \times 36,367 = 43,6(t/m2).$$

The minimum pressure under the sole of the foundation under the middle columns in the plane of the frames:

$$p_{\min 1} = p_{mt} - \frac{M_{c1}}{W} = 17,769 - \frac{7,2}{3,6} = 15,769(t/m2) > 0.$$

Minimum pressure under the sole of the foundation under the middle columns from the plane of the frames:

$$p_{\min 2} = p_{mt} - \frac{M_{c2}}{W} = 17,769 - \frac{23,8}{2,88} = 9,51(t/m2) > 0.$$

Therefore, the accepted dimensions satisfy the conditions and are accepted for further calculation of deformations.

We compare the calculated value of sedimentation with the limit value:

$$s = 20,014 \text{ mm} < s_u = 100 \text{ mm}.$$

Therefore, the accepted dimensions of the foundation for the middle columns meet the conditions and are final.

### 4.8.3. Sediment of the foundation of half-timbered column

Calculation performed according to DBN B.2.1-10-2018

Foundation under consideration

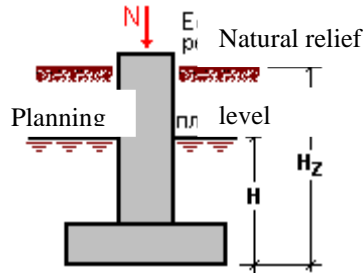

Depth of the sole of the foundation from the level of planning, H 3.1 m

Depth of foundation footing relative to natural high relief, Hz 3.1 m

Limit value of foundation deformation 100 mm

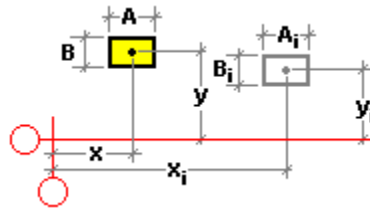

Table 4.9

Initial data

Center coordinates		Sole sizes		Longitudinal force
X	Y	A	B	N
m	m	m	m	T
0	0	1.2	1.5	18.9

Soils

Ground safety factor  $\gamma_g = 1$

Average specific gravity of the soil above the sole of the foundation  $1.65 \text{ T/M}^3$

Table 4.10

## The soil above the sole of the foundation

	Name	Layer Thickness	Specific gravity	Specific Cohesion	Angle of Internal Friction	Deformation modulus	Availability of water	Porosity coefficient	Working condition coefficients		Consider pore pressure
		m	T/m <sup>3</sup>	T/m <sup>2</sup>	degrees	T/m <sup>2</sup>			grounds	foundation	
1	II'E-5	1.5	1.88	3	17	1800	+	0.674	1.25	1	
2	II'E-6	0.5	1.75	1	25	2000	+	0.61	1.25	1	
3	II'E-5	0.6	1.88	3	17	1800	+	0.674	1.25	1	

Table 4.11

## Calculation results

The check for the level of the sole is satisfied		
Estimated soil resistance at the level of the base of the foundation	36.057	T/m <sup>2</sup>
Mean pressure from loads (including the vestibule of the foundation, soil and floor) at the level of the base of the foundation	16.7	T/m <sup>2</sup>
The sediment is defined for the base in the form of an elastic half-space		
Sediment base	9.624	mm
Load drawdown	0	mm
Settling from the weight of the soil	0	mm
Sum of draft and drawdown	9.624	mm
Depth of compressible thickness	3.44	m
Winkler bed coefficient	1735.301	T/m <sup>3</sup>

Table 4.12

## Ground layer data

	Layer thickness	Load pressure at the midpoint of the layer	Domestic pressure at the midpoint of the layer	Design pressure at the roof level of heterogeneous soil layers	Draft	Drawdown
	m	T/m <sup>2</sup>	T/m <sup>2</sup>	T/m <sup>2</sup>	mm	mm
1	0.48	15.28	5.241	0	3.46	0
2	0.48	11.113	5.493	0	2.516	0
3	0.48	6.683	5.746	0	1.513	0
4	0.06	4.873	5.888	0	0.138	0
5	0.48	3.898	6.015	39.7	0.794	0
6	0.02	3.028	6.132	0	0.026	0
7	0.48	2.541	6.263	39.787	0.575	0
8	0.48	1.793	6.515	0	0.406	0
9	0.48	1.325	6.767	0	0.196	0

The report was generated by the REQUEST program.

Maximum pressure under the sole of the foundation under the half-timbered column:

$$p_{\max} = p_{mt} + \frac{M_{\phi}}{W} = 16,7 + \frac{3,4}{0,45} = 24,26(t / m^2) < 1,2 \times 36,057 = 43,3(t / m^2).$$

Minimum pressure under the base of the foundation under the half-timbered column:

$$p_{\min} = p_{mt} - \frac{M_{\phi}}{W} = 16,7 - \frac{3,4}{0,45} = 9,14(t / m^2) > 0.$$

Therefore, the accepted dimensions satisfy the conditions and are accepted for further calculation of deformations.

We compare the calculated value of sedimentation with the limit value:

$$s = 9,624 \text{ mm} < s_u = 100 \text{ mm}.$$

Therefore, the accepted dimensions of the foundation under the extreme column satisfy the conditions and are final.

Thus, the accepted sizes of the bases are accepted for their further calculation on material.



# Appendix

## Annex 1. Calculation of the class of consequences

"Construction of a sport arena of weightlifting gym in Bila Tserkva, Kyiv region"

The project documentation provides for the sport arena of weightlifting gym with ancillary facilities, total dimensions of 18.6 x 24.7 m with the installation of internal and external utilities: electricity, water, heating, sewerage, ventilation and air conditioning, fire alarm and evacuation systems, networks internet with IP telephony. Improvement of the adjacent territory within the land plot is envisaged. Sports facilities and furniture are located in the building.

The maximum number of people who can theoretically be in the area of possible failure of the building, according to the approved mode of operation, is: periodically stay on site 22 students for 1 lesson (total lessons per day - 4 pieces), constantly on site - 5 staff members.

It is assumed that at the same time:

N1 - Number of people who are permanently on the site - 5 people;

N2 - Number of people who periodically stay on the site -  $22 \times 4 = 88$  people;

N3 - The number of people outside the facility is accepted - 93 people.

$$N_3 = N_1 + N_2 = 5 + 88 = 93$$

Given the above indicators, and in accordance with table 1 DCTU8855: 2019, the object belongs to the class of consequences SS1.

The estimated cost of construction of the object is:

29 473,407 thousand UAH

Losses from destruction and damage to fixed assets are calculated by the formula 2.1:

$$\Phi = c \sum_{i=1}^n P_i (1 - 0,5 T_{ef} \times K_{a,i}) \quad (2.1)$$

where:

n = 1 - the number of types of fixed assets

$c = 0.45$  - coefficient that takes into account the relative share of fixed assets that are completely lost in the event of failure;

$T_{ef} = 100$  years - the average value of the fixed life of fixed assets;

$K_{a,i} = 0.01$  coefficient of depreciation deductions of the  $i$ -th type of fixed assets;

$R_i = 29\,473,407$  thousand. UAH - estimated value of the  $i$ -th type of lost fixed assets.

The projected losses are determined by the formula 2.1.

$$\Phi = 0,45 * 29\,473,407 * (1 - 0,5 * 100 * 0,01) = 6\,631,516575 \text{ (thousand. UAH.)}$$

The amount of possible economic loss in the minimum wage is:

$$6\,631\,516,575 \text{ UAH} / 6\,500 \text{ UAH} = 1,0202 \text{ м.р.з.п.}$$

The building of the sport arena of weightlifting gym at the address: Bila Tserkva, st. Nekrasova, 121 Kyiv region, is not located in the protection zone of cultural heritage sites and is not a cultural heritage site.

The building of the sport arena of weightlifting gym in Bila Tserkva, Kyiv region, is located in the usual engineering-geological conditions, in the absence of such complicating conditions as: seismic, subsidence, etc.

The building of the sport arena of weightlifting gym in Bila Tserkva, Kyiv region, is not subject to increased environmental hazards.

We believe that the failure of the construction site will not lead to the closure of transport, communications and energy facilities at the national, regional and local levels.

Conclusion. According to item 4.5. [2], the class of consequences of the construction object is set according to the highest characteristics of possible consequences obtained from the results of calculations.

According to the criterion of table. 1 [2], the object belongs to the class of consequences CC1.

According to the criteria of general requirements, the object "Construction of the sport arena of weightlifting gym in Bila Tserkva, Kyiv region", belongs to the class of consequences CC1.

## Annex 2. Calculation of evacuation time

"Construction of a sport arena of weightlifting gym in Bila Tserkva, Kyiv region"

### 1. BASIC PROVISIONS FOR CALCULATING THE TIME OF EVACUATION OF PEOPLE FROM THE HOUSE IN THE EVENT OF FIRE.

1.1 Methodical approaches to calculating the time of evacuation of people from home.

Determination of the estimated evacuation of people from the premises was performed using a simplified analytical model of human flow.

The estimated time is set by calculating the time of movement of one or more human flows through the evacuation exits from the most remote locations of people to the exit. The estimated time of evacuation is defined as the sum of the time of movement of individual sections of the road, taking into account the confluence of human flows, their separation, the formation of clusters in doorways or areas of unsatisfactory capacity by the formula:

$$t_p = t_1 + t_2 + t_3 + \dots + t_i, \quad (1.1),$$

where  $t_1$  is the time of movement on the first (initial) section, min .;

$t_2, t_3, \dots, t_i$  - time of movement of human flow on each subsequent after the first section of the path, min.

The time of movement of human flow on the first section of the path ( $t_1$ ), is calculated by the formula:

$$t_1 = l_1 / v_1, \quad (1.2)$$

where  $l_1$  is the length of the first section of the path, m;

$v_1$  is the value of the velocity of human flow along the horizontal path in the first section, determined according to table 1.1 depending on the density of human flow  $D$  m / min

The density of human flow in the first section is determined by the formula:

$$D_1 = N_1 f / l_1 \delta_1, \quad (1.3)$$

where  $N$  is the number of people in the first section, people;

$f$  - The average area of the horizontal projection of a person, which is assumed to be equal,  $m^2$ :

for an adult in home clothes - 0.1; for an adult in winter clothes - 0.125; for a teenager - 0.07;

$\delta_1$  – width of the first section of the road.

The speed of human traffic on sections of the road following the first are taken from table 1 depending on the value of the intensity of human traffic on each section of the road, which is calculated for all sections, including doorways by the formula:

$$q_i = \left( \sum_{j=1}^{i-1} [q_{j-1} \cdot \delta_{j-1}] \right) / \delta_i, \quad (1.4)$$

where,  $\delta_i$ ,  $\delta_{i-1}$  width of the considered  $i$ -th previous section of the road;  $m$ ,

$q_i$ ,  $q_{i-1}$  the value of traffic on the section under consideration in the  $i$ -th and the previous section of the road,  $m / \text{min.}$ , the value of traffic intensity on the road section, is determined in table A.1 by the value of  $D_1$ .

If the value of  $q_i$  is less than or equal to the value of  $q_{\max}$ , then the travel time along the path ( $t_1$ ) per minute:  $t_1 = l_1 / v_1$ ,

the value of  $q_{\max}$  should be taken equal to,  $m / \text{min.}$ :

for horizontal paths - 16.5

for doorways - 19.6

- for stairs down - 16

For stairs up - 11

The value of the intensity of human flow in the first section of the path ( $q_i = q_{i-1}$ ) is determined according to table 1 by the value of  $D$ , determined by formula (1.3).

If the value of  $q_i$ , determined by formula (1.4), is greater than the value of  $q_{\max}$ , intensity and speed of human flow in sections of the path is determined in table (A.1) at a value of flow density  $D = 0.9 \text{ m}^2 / \text{m}^2$ . This should take into account the delay time  $\tau$  people in this area.

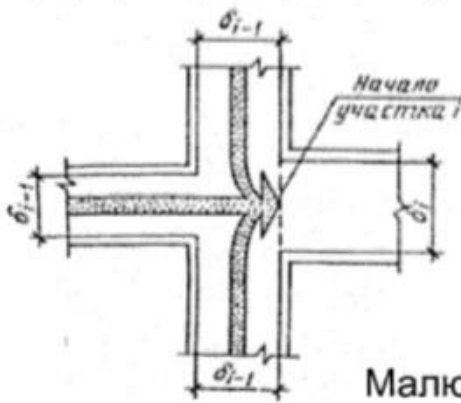

Малюнок 1.1 Злиття людських потоків

Таблиця А.1 — Інтенсивність і швидкість руху людського потоку різними ділянками шляхів евакуації в залежності від щільності для групи мобільності М1

Щільність потоку $D$ , $\text{м}^2/\text{м}^2$	Горизонтальний шлях		Дверний проріз, інтенсивність $q$ , $\text{м}/\text{хв}$	Сходи вниз		Сходи вгору	
	Швидкість $V$ , $\text{м}/\text{хв}$	Інтенсивність $q$ , $\text{м}/\text{хв}$		Швидкість $V$ , $\text{м}/\text{хв}$	Інтенсивність $q$ , $\text{м}/\text{хв}$	Швидкість $V$ , $\text{м}/\text{хв}$	Інтенсивність $q$ , $\text{м}/\text{хв}$
0,01	100	1,0	1,0	100	1,0	60	0,6
0,05	100	5,0	5,0	100	5,0	60	3,0
0,10	80	8,0	8,7	95	9,5	53	5,3
0,20	60	12,0	13,4	68	13,6	40	8,0
0,30	47	14,1	16,5	52	15,6	32	9,6
0,40	40	16,0	18,4	40	16,0	26	10,4
0,50	33	16,5	19,6	31	15,6	22	11,0
0,60	28	16,3	19,05	24,5	14,1	18,5	10,75
0,70	23	16,1	18,5	18	12,6	15	10,5
0,80	19	15,2	17,3	13	10,4	13	10,4
0,90 і більш	15	13,5	8,5	8	7,2	11	9,9

Примітка. Інтенсивність руху в дверному прорізі при щільності потоку 0,9 і більше, рівна 8,5 м/хв, встановлена для дверного прорізу завширшки 1,6 м і більше, а при дверному прорізі меншої ширини  $b$  інтенсивність руху слід визначати за формулою  $q = 2,5 + 3,75 \cdot b$ .

To take into account the specifics of the movement of LOW MOBILE POPULATION GROUPS (MGN) along the evacuation routes, additional calculated values of the MGN movement parameters should be used.

B 1. According to the mobile qualities of people in the stream, who are evacuated from buildings and structures should be divided into 4 groups according to table B.1.

Table B.1.

### Evacuated from buildings and structures

Mobility groups	General characteristics of people in mobility groups	The average area of horizontal projection of people $m$
-----------------	--	---

M1	People who do not have mobility restrictions, including those with hearing impairments	0,1
M2	Weak people whose mobility is reduced due to aging (disabled in old age); disabled people on prostheses; visually impaired people who use a white cane; people with mental disorders	0,2
M3	Disabled people who use additional supports when moving (crutches, sticks)	0,3
M4	Disabled people moving in wheelchairs manually driven	0,96

Estimated values of speed and intensity of traffic flows of people with different mobility groups should be determined by the formulas:

$$V_{D,j} = V_{0,j} \left( 1 - a_j \ln \frac{D}{D_{0,j}} \right), \text{ at } D > D_{0,j}; \quad (1.5)$$

$$q_{D,j} = V_{D,j} D$$

where  $V_{D,j}$ ,  $q_{D,j}$  - speed and intensity of movement of people in the flow on the  $j$ -th type of path at the density of the flow  $D_i$ ;

$D$ - density of human flow in the area of the escape route,  $m / m^2$ ;

$D_{0,j}$  - the value of the density of human flow on the  $j$  -th type of path, at which the density of the flow begins to affect the speed of movement of people in;

$V_{0,j}$  is the average value of the speed of free movement of people on the  $j$  -th type of path at the values of flow density;

Values  $V_{0,j}$ ,  $a_{0,j}$ ,  $D_{0,j}$ , for flows of people of different mobility groups for formulas (B.1) and (B.2) are given in table B.2.

The value of the parameters by path types

Mobility groups	Parameter values	The value of the parameters by path types (j)				
		horizontal	go down	go up	ramp down	ramp up
M1	$V_{0,j}$	100	100	60	115	80
	$D_{0,i}$	0,051	0,089	0,067	0,171	0,107
	$q_{0,j}$	0,295	0,400	0,305	0,399	0,399
M2	$V_{0,j}$	30	30	20	45	25
	$D_{0,i}$	0,135	0,139	0,126	0,171	0,146
	$q_{0,j}$	0,335	0,346	0,348	0,438	0,384
M3	$V_{0,j}$	70	20	25	105	55
	$D_{0,i}$	0,102	0,208	0,120	0,122	0,136
	$q_{0,j}$	0,350	0,454	0,347	0,416	0,446
M4	$V_{0,j}$	60	-	-	115	40
	$D_{0,i}$	0,135	-	-	0,146	0,150
	$q_{0,j}$	0,400	-	-	0,424	0,420

The time of movement of human flow in this area is determined by the formula:



$$t_i = t_{cл} + \tau$$

where  $t_{cл}$  - travel time on the site at the minimum speed of human flow, as determined by table A.1 when the value of flow density  $D = 0.9 \text{ m}^2 / \text{m}^2$  and more, min .;

$\tau$  - delay time, min.

Delay time at the site is determined by the formula:

$$\tau = N * f * \left( \frac{1}{q_{\text{гран}} * \delta_i} - \frac{1}{\sum q_{i-1} * \delta_{i-1}} \right) \quad (1.7)$$

where  $N$  is the number of people on a certain section of the road;

$q_{\text{face}}$  - the limit value of the intensity of the movement of human flow in its density, exceeding  $D = 0.9 \text{ m}^2 / \text{m}^2$ ;

$\delta_i$  - width of the section of the evacuation route where the stop occurred, m;

$q_{i-1} * \delta_{i-1}$  - total capacity on the sections of the evacuation route that preceded the last one, where there was a traffic delay,  $\text{m}^2 / \text{min}$ .

At the merger of the first section and two or more human flows (Figure 1.1), the intensity of movement ( $q_i$ ),  $\text{m} / \text{min}$ ., Is calculated by the formula:

$$q_i = \frac{\sum q_{i-1} * \delta_{i-1}}{\delta_i}, \quad (1.8)$$

where  $q_{i-1}$  is the intensity of the movement of human flows that merge at the beginning of the section and,  $\text{m} / \text{min}$ ;

$\delta_{i-1}$  - width of the considered section of the road, m

where  $q_{i-1}$  is the intensity of the movement of human flows that merge at the beginning of the section and,  $\text{m} / \text{min}$ ;

$\delta_{i-1}$  - width of the considered section of the road, m

The maximum intensity of movement in the door, if the width of the door slot less than 1.6 m, determined by the formula:

$$q_{\text{дв.}} = 2.5 + 3.75 * \delta \quad (1.9)$$

1.2. Method of determining the time from the beginning of the fire to the blocking of escape routes as a result of the spread of dangerous factors (factors) of the fire

The time from the beginning of the fire to the blocking of escape routes as a result of the spread of dangerous fire factors is determined by choosing from the resulting values of the critical duration of the fire minimum time:

The critical duration of the fire for each of the hazardous factors is defined as the time when this factor reaches a critical value on the evacuation routes at a height of 1.7 m from the floor.

Indoor, the critical duration of the fire  $t_{kr}$  (c), provided that each of the fire hazards reaches the maximum allowable values in the area of human presence (working area) can be estimated by the formulas:

As the temperature rises.

*As the temperature rises.*

$$t_{kpm} = \left[ \frac{B}{A} \cdot \ln \left[ 1 + \frac{(70-t_0)}{(273+t_0) \cdot Z} \right] \right]^{\frac{1}{n}} \quad (1.10)$$

*On loss of visibility*

$$T_{kpn\theta} = \left[ \frac{B}{A} \cdot \ln \left[ 1 - \frac{V \cdot \ln(1.05\alpha \cdot E)}{\ln p \cdot B \cdot D_m \cdot Z} \right]^{-1} \right]^{\frac{1}{n}} \quad (1.11)$$

*By lowering the oxygen content*

$$t_{kpo_2} = \left[ \frac{B}{A} \cdot \ln \left[ 1 - \frac{0.044}{\left( B \cdot \frac{L_{o_2}}{V} + 0.27 \right) \cdot Z} \right]^{-1} \right]^{\frac{1}{n}} \quad (1.12)$$

*For each of the gaseous toxic combustion products:*

$$t_{kpcO} = \left[ \frac{B}{A} \cdot \ln \left[ 1 - \frac{V \cdot X}{B \cdot L_{CO} \cdot Z} \right]^{-1} \right]^{\frac{1}{n}} \quad (1.13)$$

$$Z = h/H \cdot \exp(1.4h/H) \quad (1.14)$$

$$B=353 \cdot C_p \cdot 0,8V / (1-\varphi)\eta Q \quad (1.5)$$

$$A=1.05 \cdot \Psi_{yD} \cdot v^2 \quad (1.16)$$

where  $t_0$  is the initial temperature of the room, ° C;

$B$  - complex, which depends on the heat of combustion of the material and the free volume of the room, kg;

$n$  - exponent, which takes into account the change in mass of the combustible material over time;

$A$  is a dimensional parameter that takes into account the specific mass rate of combustion of the combustible substance and the area of the fire, kg / sn, for the case of circular spread of flame on the surface of combustible substance or material;

$Z$  - dimensionless parameter that takes into account the uneven distribution of the dangerous factor of fire on the height of the room;

$Q$  is the lowest heat of combustion of the material, MJ / kg;

$SR$  - specific isobaric heat capacity of air, MJ / kg;

$\varphi$  is the coefficient of heat loss;

$\eta$  is the coefficient of completeness of combustion;

$V$  - free volume of the room, m<sup>3</sup>;

$\alpha$  is the coefficient of reflection of objects on the evacuation route;

$E$  - initial lighting, lux;

$L_{gr}$  - maximum range of visibility in smoke, m;

$L$  - specific yield of toxic gases during combustion of 1 kg of combustible substance, kg / kg;

$X$  - maximum allowable content of toxic gas in the room, kg / m<sup>3</sup>;

$Lo_2$  - specific oxygen consumption, kg / kg.

$h$  is the height of the working area, m;

$H$  - height of the room, m

The height of the working area is determined by the formula

$$H = h_{pl} + 1.7 - 0.5\delta \quad (1.17)$$

where  $h_{pl}$  - the height of the site where people are, above the floor, m;

$\delta$  is the difference in floor height equal to zero when placed horizontally, m

1.3 Methods for determining the required time for evacuation of people from house in case of fire

From the obtained results of calculations of critical duration of fire choose the minimum.

The required time of evacuation of people ( $t_n$ ) is determined by the formula:  
 $t_{nb} = 0.8 \cdot t_{kr}$  (1.18)

where  $t_{kr}$  - time to reach critical values of hazardous factors fires in the volume under consideration, min.

2. Estimated duration of evacuation from the premises "Construction of the weightlifting sports hall of the Kyiv Regional Council" Kyiv Regional Children's and Youth Sports School "on the territory of secondary school №20 on the street. Nekrasova, 121 in Bila Tserkva, Kyiv region "

2.1 Determination of the estimated evacuation of people from the premises of the hall (Note 21)

This calculation is performed in accordance with DSTU 8828: 2019.

Input parameters:

1. Name of the building: "Construction of the weightlifting sports hall of the Kyiv Regional Council" Kyiv Regional Children's and Youth Sports School "on the territory of secondary school №20 on the street. Nekrasova, 121 in Bila Tserkva, Kyiv region
2. Degree of fire resistance of the building - IIIa
3. The building is one-story
4. Area of premises: 414.51 m<sup>2</sup>
5. The height of the room is 3-5 m
6. The total volume of premises is 2959.11 m<sup>3</sup>,
7. Number of persons who can stay in the premises at the same time №21 - 25 (3 coaches and 22 children) persons, 2 more adults (medical worker and cleaner) are in the adjacent premises at the same time

$t_o=$	20	Initial room temperature, °C;
$Q=$	14	Lower heat of combustion of material, MJ / kg;
$v=$	0,0045	Linear flame speed, m / s;
$\Psi_{уд}=$	0,0137	Specific burnout rate, kg / m <sup>2</sup> s;
$D_m$	23	Smoke-generating capacity of the material, Npm <sup>2</sup> /
$C_p=$	$1,02 \times 10^{-3}$	Specific isobaric heat capacity of gas, MJ / kgK;
$\varphi=$	0,6	Heat loss coefficient;
$\eta=$	0,95	Combustion completeness coefficient;
$E=$	50	Initial illumination, lux;
$\alpha =$	0,3	Coefficient of reflection of objects on evacuation routes;
$l_{np}=$	20	Maximum range, visibility in smoke, m;
$X_{CO_2}$	0,11	Maximum permissible content of toxic gas in the room, kg / m <sup>3</sup> ;
$X_{CO}=$	$1,16 \times 10^{-6}$	
$X_{HCl}$	$23 \times 10^{-6}$	
$L_{O_2}=$	1,369	Specific oxygen consumption kg / kg
$L_{CO_2}$	1,478	Specific CO <sub>2</sub> emissions, kg / kg
$L_{CO}=$	0,03	Specific release of CO, kg / kg
$L_{HCl}$	0,006	Specific allocation of NSI, kg / kg
$H=$	3	Room height, m;
$h=$	1,7	Height of a working zone, m;
$V=$	1086,6	Free volume of the room, m <sup>3</sup>

$$Z=1,7/4,5 \cdot \exp(1,4 \cdot 1,7/4,5)=0,6411;$$

$$B=353 \cdot 1,02 \cdot 10^{-3} \cdot 1086,6 / (1-0,6) \cdot 0,95 \cdot 14=121,9 \text{ (кГ)};$$

$$A=1,05 \cdot 0,0137 \cdot 0,0045^2=2,91 \cdot 10^{-7}$$

Calculate the value of the critical duration of the fire (t<sub>кр</sub>), provided that each of the NFP reaches the maximum allowable values in the area of human presence:

to increase the temperature

$$t_T = \left( \frac{121,9}{(2,9 \cdot 10^{-7})} \cdot \ln \left( \frac{70-20}{(273+20) \cdot 0,64} \right) \right)^{1/3} = 475,49 \text{ c}$$

$$t_{крT} = 475,49 \cdot 0,8 / 60 = 6,33 \text{ хВ}$$

*On loss of visibility*

$$T_B = (121,9 / (2,9 * 10^{-7}) * \ln(1 - (353,98 * \ln(1,05 * 0,3 * 50) / (50 * 353,98 * 23 * 0,64))^{-1}))^{1/3} = 390,41 \text{ c}$$

$$T_{\text{крПВ}} = T_B * 0,8 / 60 = 459,41 * 0,8 / 60 = 5,2 \text{ хВ}$$

*By lowering the oxygen content*

$$t_{\text{кpo}2} = (121,9 / (2,9 * 10^{-7}) * \ln(1 - (0,044 / (14,61 * 1,369 / 353,98 + 0,27) * 1,25)))^{1/3} = 502,65$$

$$T_{\text{кpo}2} = 502,65 * 0,8 / 60 = 6,7 \text{ хВ}$$

*by content CO<sub>2</sub>*

$$t_{\text{co}2} = ((14,61 / 2,9 * 10^{-7}) * \ln(1 - (215,92 * 0,11) / (14,61 * 1,478 * 1,25)))^{-1})^{1/3}$$

under the logarithm, a negative number parameter is not taken into account

The required evacuation time is determined by the lowest value of ttnb is 5.2 minutes. The greatest danger for people in the chosen fire scenario is the loss of visibility due to smoke in the room, provided that the fire is burning in a circular shape, which increases over time.

3. Calculation of the actual time of evacuation of people from the premises the sports arena of weightlifting on the street. Nekrasova, 121 in Bila Tserkva, Kyiv region.

The estimated time of evacuation is determined in the following sequence:

- 1) The longest evacuation route is determined;
  - 2) The parameters of human flow are determined;
- The time of movement on each site is summed up.

3.1 Calculation of the actual time of evacuation of people from the premises:

The fire in the room pos.21 is considered as a model fire

Exits in two directions are considered as evacuation exits - through room 9.3 to vestibule 1 and exit directly to the outside. All 27 people can be in these premises at the same time, there is no mobile group of the population.

Direction 1 - through room 9.3 to the vestibule 1 and exit,

Direction 2 - directly outside.

1 plot (approx. 9). Capacity -  $N_1 = 25$  people, length -  $l_1 = 9$  m; width -  $\delta_1 = 1,5$ m (horizontal movement)

The density of human flow  $D$  on the first section of the path, length  $l_1$  and width  $\delta_1$ , should be determined by the formula:

$$D_1 = (N_1 \times f) / (l_1 \times \delta_1)$$

$$D_1 = (25 \text{ people} \times 0.1 \text{ m}^2) / (9 \text{ m} \times 1.5 \text{ m}) = 0.18$$

where  $N_1$  is the number of people in the first section, people;

$f$  is the average area of the horizontal projection of a person.

$V_1 = 60.0$  - value of speed of movement;  $q_1 = 12,0$  - the value of traffic intensity

The velocity of human flow  $t_1 = 9.0 / 60 \text{ m min} = 0.15 \text{ min}$ ;

2 plot (note 3). Capacity -  $N_2 = 27$  people, length -  $l_2 = 9.0$  m. Width -  $\delta_2 = 2.8$  m (horizontal movement)

$$D_2 = (N_2 \times f) / (l_2 \times \delta_2) = (27 \text{ people} \times 0.1 \text{ m}^2) / (9 \text{ m} \times 2.8 \text{ m}) = 0.1$$

$B_2 = 80.0$ ;  $q_2 = 8.0$

$$t_2 = 9 \text{ m} / 80 \text{ m min.} = 0.11 \text{ min}$$

3 plot (note 1);  $N_3 = 27$  people; length -  $l_3 = 2.0$  m width -  $\delta_3 = 2.0$  m

$$D_3 = (N_3 \times f) / (l_3 \times \delta_3) = (27 \text{ people} \times 0.1 \text{ m}^2) / (2 \text{ m} \times 2.0 \text{ m}) = 0.45$$

$B_3 = 33.0$ ;  $q_3 = 16.5$

$$t_3 = 2 \text{ m} / 33 \text{ m min.} = 0.06 \text{ min}$$

$$t_{p1} = t_1 + t_2 + t_3 + \dots + t_i$$

$$t_{p1} = t_{p3} = t_1 + t_2 + t_3 = 0.15 + 0.11 + 0.06 = 0.32 \text{ min}$$

The value of the duration of the beginning of the evacuation in accordance with tab.A3 DSTU 8828: 2019 is 180 s.

Accordingly, the estimated time of evacuation from the building in direction 1 will be 3.32 minutes, which is less than the required 5.2 minutes.

Direction 2 - directly outwards through the input group №2.

The calculation was not performed, as the exit from the room 21 directly to the outside, respectively, the time of evacuation is accepted in accordance with tab. A3 DSTU 8828: 2019 - 180 p.

Conclusion: the estimated time of evacuation of people from the building in the most dangerous scenario (fire directly near the entrance group 2 from room 21) is 3.32 minutes, which is less than the required evacuation time until the loss of visibility in the room 5.2 minutes.

Taking into account the above results, evacuation of people from the premises of the sports arena of weightlifting on the street. Nekrasova, 121 in Bila Tserkva, Kyiv region, will be safe in case of fire if the fire safety requirements set forth in the regulations, building codes and national standards of Ukraine are met.



## **Conclusions**

In this qualifying work of the bachelor, the design of the sports arena of weightlifting in the city of Bila Tserkva was performed.

In the diploma work the constructive decision of construction with a metal framework is offered.

Calculations of the main bearing elements: columns, truss.

The calculation and construction of columnar monolithic foundations is carried out.

Developed drawings of the architectural part, structural and foundations.

The calculation of the class of consequences and heat calculation of enclosing structures are considered.

The calculations in the settlement complex of SKAD Office are given.

## List of sources used

1. ДБН В.2.2-13:2003 «Спортивні та фізкультурно-оздоровчі споруди»
2. ДСТУ 8855:2019 «Визначення класу наслідків»
3. ДБН В.2.2-40:2018 «Інклюзивність будівель і споруд»
4. ДСТУ Б А.2.4-4: 2009 «Основні вимоги до проектної та робочої документації»
5. ДБН В.2.5-64:2012 «Внутрішній водопровід та каналізація»
6. ПУЕ:2017 «Правила улаштування електроустановок»
7. ДСТУ Б В.2.7-23-95 «Розчини будівельні»
8. ДБН В.2.5-28-2018 «Природне і штучне освітлення»
9. ДБН В.2.6-31:2016 «Теплова ізоляція будівель (+ 2006, 2013) »
10. ДСТУ Б В.2.6-189:2013 «Методи вибору теплоізоляційного матеріалу для утеплення будівель»
11. ДСТУ 2867 – 94 «Шум. Методи оцінювання виробничого шумового навантаження. Загальні вимоги»
12. ДБН В.1.1.7-2016 «Пожежна безпека об'єктів будівництва»
13. ДБН А.3.1-5:2016 «Організація будівельного виробництва»
14. ДБН А.2.2-3:2014 «Склад та зміст проектної документації на будівництво»
15. ДБН А.3.2-2-2009 «Охорона праці і промислова безпека у будівництві»
16. ДБН В.1.2-14:2018 «Загальні принципи забезпечення надійності та конструктивної безпеки будівель і споруд»
17. ДСТУ Б В.2.6-8-95 (ГОСТ 30245-94) «Будівельні конструкції. Профілі сталеві гнуті замкнуті зварні квадратні і прямокутні для будівельних конструкцій. Технічні умови»
18. ДБН Б.2.2-12:2018 «Планування і забудова територій міських і сільських поселень»
19. ДСТУ Б В.2.7-176:2008 «Суміші бетонні та бетон. Загальні технічні умови»
20. ДСТУ 3760:2019 «Прокат арматурний для залізобетонних конструкцій. Загальні технічні умови»
21. ДБН В.2.5-67:2013 «Опалення, вентиляція та кондиціонування»
22. ДСТУ Б В.2.7-167:2008 «Вироби теплоізоляційні з мінеральної вати на синтетичному зв'язуючому»
23. ДБН В.1.2-7-2008 «Система забезпечення надійності та безпеки будівельних об'єктів. Основні вимоги до будівель і споруд. Пожежна безпека»
24. НАПБ А.01.001-2014 «Правила пожежної безпеки в Україні»

25. ДБН В 1.2-2-2006 «Навантаження і впливи»

26. ДБН В.2.5-64:2012 «Внутрішній водопровід та каналізація»