

**МІНІСТЕРСТВО ОСВІТИ І НАУКИ УКРАЇНИ**  
**НАЦІОНАЛЬНИЙ АВІАЦІЙНИЙ УНІВЕРСИТЕТ**  
**КАФЕДРА КОНСТРУКЦІЇ ЛІТАЛЬНИХ АПАРАТІВ**

**ДОПУСТИТИ ДО ЗАХИСТУ**  
Завідувач кафедри  
д.т.н., професор  
\_\_\_\_\_Сергій ІГНАТОВИЧ  
«\_\_» \_\_\_\_\_ 2022 р.

**КВАЛІФІКАЦІЙНА РОБОТА**  
**ВИПУСКНИКА ОСВІТНЬОГО СТУПЕНЯ МАГІСТРА**  
**ЗІ СПЕЦІАЛЬНОСТІ**  
**«АВІАЦІЙНА ТА РАКЕТНО-КОСМІЧНА ТЕХНІКА»**

**Тема: «Оптимізація посадки на борт літака»**

<b>Виконавець:</b>	_____	<b>Іван ГОРЯН</b>
<b>Керівник: к.т.н., доцент</b>	_____	<b>Тетяна МАСЛАК</b>
<b>Охорона праці: к.т.н., доцент</b>	_____	<b>Катерина КАЖАН</b>
<b>Охорона навколишнього середовища:</b>		
<b>к.т.н., професор</b>	_____	<b>Леся ПАВЛЮХ</b>
<b>Нормоконтролер: к.т.н., доцент</b>	_____	<b>Володимир КРАСНОПОЛЬСЬКИЙ</b>

**Київ 2022**

**MINISTRY OF EDUCATION AND SCIENCE OF UKRAINE**  
**NATIONAL AVIATION UNIVERSITY**  
**DEPARTMENT OF AIRCRAFT DESIGN**

**PERMISSION TO DEFEND**

Head of the department,

Dr. of Sc., professor

\_\_\_\_\_ **Sergiy IGNATOVYCH**

"\_\_" \_\_\_\_\_ 2022

**MASTER DEGREE THESIS**  
**ON SPECIALITY**  
**"AVIATION AND ROCKET-SPACE TECHNOLOGIES"**

**Topic: "Optimization of aircraft boarding processes"**

<b>Fulfilled by:</b>	_____	<b>Ivan HORIAN</b>
<b>Supervisor:</b> <b>PhD, associate professor</b>	_____	<b>Tetiana MASLAK</b>
<b>Labor protection advisor:</b> <b>PhD, associate professor</b>	_____	<b>Katerina KAZHAN</b>
<b>Environmental protection adviser:</b> <b>PhD, professor</b>	_____	<b>Lesya PAVLYUKH</b>
<b>Standards inspector:</b> <b>PhD, associate professor</b>	_____	<b>Volodymyr</b> <b>KRASNOPOLSKYI</b>

**Kyiv 2022**

# НАЦІОНАЛЬНИЙ АВІАЦІЙНИЙ УНІВЕРСИТЕТ

Факультет аерокосмічний

Кафедра конструкції літальних апаратів

Освітній ступінь «Магістр»

Спеціальність 134 «Авіаційна та ракетно-космічна техніка»

Освітньо-професійна програма «Обладнання повітряних суден»

**ЗАТВЕРДЖУЮ**

Завідувач кафедри

д.т.н., професор

\_\_\_\_\_ Сергій ІГНАТОВИЧ

«\_\_\_» \_\_\_\_\_ 2022 р.

## **ЗАВДАННЯ**

**на виконання кваліфікаційної роботи пошукача**

**ГОРЯНА Івана**

1. Тема роботи «Оптимізація посадки на борт літака», затверджена наказом ректора від 05 жовтня 2022 року №1861/ст.
2. Термін виконання роботи: з 06 жовтня 2022 р. по 30 листопада 2022 р.
3. Вихідні дані до роботи: геометричні параметри літака, компонування місць всередині фюзеляжу.
4. Зміст пояснювальної записки: питання про економічну цінність простою літака; фактори, що впливають на час простою; існуючі методи та стратегії посадок пасажирів у літак; аналіз симуляцій методів посадки; питання охорони праці та навколишнього середовища.
5. Перелік обов'язкового графічного (ілюстративного) матеріалу: презентація Power Point, малюнки та схеми.

6. Календарний план-графік:

№	Завдання	Термін виконання	Відмітка про виконання
1	Огляд літератури про процеси «повного оберту» літака	06.10.2022- 18.10.2022	
2	Вивчення факторів, що впливають на економічну цінність простою літака	19.10.2022- 29.10.2022	
3	Аналіз існуючих методів на стратегій посадки пасажирів на літак	30.10.2022- 07.11.2022	
4	Аналіз даних та вибір оптимального методу посадки	06.10.2022- 31.10.2022	
5	Виконання розділів, присвячених охороні навколишнього середовища та праці	01.11.2022- 04.11.2022	
6	Оформлення кваліфікаційної роботи	05.11.2022- 10.11.2022	

7. Консультанти з окремих розділів:

Розділ	Консультанти	Дата, підпис	
		Завдання видав	Завдання прийняв
Охорона праці	к.т.н., доцент Катерина КАЖАН		
Охорона навколишнього середовища	к.т.н., професор Леся ПАВЛЮХ		

8. Дата видачі завдання: 5 жовтня 2022 р.

Керівник кваліфікаційної роботи: \_\_\_\_\_ Тетяна МАСЛАК

Завдання прийняв до виконання: \_\_\_\_\_ Іван ГОРЯН

# NATIONAL AVIATION UNIVERSITY

Aerospace Faculty

Department of Aircraft Design

Educational Degree "Master"

Specialty 134 "Aviation and Rocket-Space Technologies"

Educational Professional Program "Aircraft Equipment"

## APPROVED BY

Head of Department,

Dr. of Sc., professor

\_\_\_\_\_ Sergiy IGNATOVYCH

"\_\_" \_\_\_\_\_ 2022

## TASK

**for the master degree thesis**

**HORIAN Ivan**

1. Topic: "Optimization of aircraft boarding processes", approved by the Rector's order № 1861/CT from 05 October 2022 year.
2. Period of work execution: from 05 October 2022 year to 30 November 2022 year.
3. Initial data: geometrical parameters of the aircraft, the layout of the boarding seats inside of the fuselage.
4. Content: the question of the economic value of aircraft turnaround time; factors affecting on turnaround time; existing methods and strategies of passenger boarding; analysis of simulations of boarding methods; labor and environmental protection.
5. Required material: Power Point Presentation, drawings and diagrams.

6. Thesis schedule:

No	Task	Time limits	Done
1	Review of the literature on the processes of "turnaround time" of the aircraft	06.10.2022- 18.10.2022	
2	Study of factors affecting the economic value of aircraft turnaround time	19.10.2022- 29.10.2022	
3	Analysis of existing methods of passenger boarding strategies	30.10.2022- 07.11.2022	
4	Data analysis and selection of the optimal boarding method	06.10.2022- 31.10.2022	
5	Implementation of the parts, devoted to environmental and labor protection	01.11.2022- 04.11.2022	
6	Edit and correct the draft, modify the format	05.11.2022- 10.11.2022	

7. Special chapter advisers:

Chapter	Adviser	Date, signature	
		Task issued	Task received
Labor protection	PhD, associate professor Katerina KAZHAN		
Environmental protection	PhD, professor Lesya PAVLYUKH		

8. Date of issue of the task: 8 September 2022 year.

Supervisor: \_\_\_\_\_

Tetiana MASLAK

Student: \_\_\_\_\_

Ivan HORIAN

## РЕФЕРАТ

Пояснювальна записка до кваліфікаційної роботи на тему «Оптимізація посадки на борт літака»:

79 сторінок, 16 рисунків, 6 таблиць, 26 джерел

В представленій кваліфікаційній роботі об'єктом дослідження є аналіз стратегій та методів посадки на борт пасажирського літака. Предметом дослідження є вибір оптимального та ефективного методу посадки, визначення його переваг в порівнянні з іншими стратегіями та методами посадки.

Метою кваліфікаційної роботи є визначення найоптимальнішого методу посадки пасажирів на борт літака для зменшення економічних втрат від простою шляхом зменшення часу перебування літака в аеропорту.

Методами дослідження є: аналіз наукових робіт з оптимізації методів посадки пасажирів на борт літака та проблематики простою літаків, аналіз принципів посадки, визначення найвпливовіших моментів на протокол посадки, визначення ефективної стратегії посадки.

Кваліфікаційна робота включає аналіз симуляцій різноманітних стратегій посадки пасажирів на борт літака, і їх вибір для того, щоб максимально скоротити час перебування повітряних суден на землі.

Практична цінність роботи полягає у виконанні аналізу, вибору, та визначенні більш оптимальної стратегії посадки для середньомагістрального пасажирського літака.

Матеріали кваліфікаційної роботи можуть бути використані в авіаційній промисловості та в навчальному процесі, пов'язаному з вивченням конструкції та міцності літака, обладнання повітряних суден, пасажирських перевезень.

**Аванпроект, пасажирський літак, компонування, час простою, посадка, стратегія, ефективність**

## ABSTRACT

Master degree thesis “Optimization of aircraft boarding processes”:

79 pages, 16 figures, 6 tables, 26 references

In the presented qualification work, the object of research is the analysis of strategies and methods of boarding passengers on board of passenger aircraft. The subject of study is the select of optimal and effective method of boarding, to determine its advantages over other strategies and methods of boarding.

The aim of the qualification work is to determine the most optimal method of boarding passengers on board the aircraft to reduce economic losses from downtime by reducing the time of turnaround of the aircraft.

The methods of research are: analysis of scientific works on optimization of methods of boarding passengers on board the aircraft and the problems of aircraft downtime, analysis of the principles of boarding, determination of the most significant moments on the boarding protocol, determination of an effective boarding strategy.

The qualification work includes the analysis of simulations of various strategies for boarding passengers on board the aircraft, and their selection in order to minimize the time spent by aircraft on the ground.

The practical value of the work is to analyze, select, and determine a more optimal boarding strategy than those currently used for midrange passenger aircraft.

The materials of the master's thesis can be used in the aviation industry and in the educational process related to the study of basics of regulation of passenger transportation by air transport, aircraft design and strength, passenger equipment and furnishings.

**Preliminary design, passenger aircraft, layout, turnaround time, boarding, strategy, efficiency**



## **ABBREVIATIONS**

ATFM - Air Traffic Flow Management

IATA - International Air Transport Association

UTC – Universal Coordinated Time

APOC - Airport Operations Center

A-CDM – Airport Collaborative Decision-Making

TOBT – Target Off-Block Time

ICAO - International Civil Aviation Organization

HT – Horizontal Tail

TLC – Take-off and Landing Cycle

MPC – Maximum Permissible Concentration

SARPS - Standards and Recommended Practices

# CONTENT

INTRODUCTION.....	11
PART 1. PASSENGER TRANSPORTATION REGULATIONS.....	12
1.1. The law basics of regulation of passenger transportation by air transport	12
1.2. Boarding of passengers on board of an aircraft to minimize turn-around time .....	19
Conclusion to part 1 .....	24
PART 2. PRELIMINARY DESIGN OF THE MID-RANGE PASSENGER AIRCRAFT .....	25
2.1. The law basics of regulation of passenger transportation by air transport	25
2.2. The choice of the main parameters of the aircraft .....	27
2.3. Brief description of the designed airplane .....	30
2.3.1. Fuselage design.....	31
2.3.2. Wing design .....	35
2.3.3. Tail unit design .....	39
2.3.4. Landing gear design.....	41
2.3.5. Engine selection.....	44
Conclusion to part 2 .....	44
PART 3. AIRCRAFT BOARDING STRATEGY.....	45
3.1. Methods for boarding a commercial airplane.....	46
3.1.1. Conflicts during boarding .....	47
3.1.2. “Random” boarding strategy .....	48
3.1.3. The “back-to-front” boarding strategy .....	49
3.1.4. The “front-to-back” boarding strategy .....	50
3.1.5. The “windows-middle-aisle” boarding strategy .....	51
3.2. Conceptual design of efficient boarding strategy .....	52
3.2.1. “Reverse pyramid” boarding strategy.....	53
Conclusion to part 3 .....	55
PART 4. ENVIRONMENTAL PROTECTION.....	56
4.1. Introduction.....	56
4.2. Water vapor.....	59

4.3. Effects of carbon black .....	59
4.4. Ozone .....	60
4.5. Sound, vibrations and other effects of civil aviation and technical means of supporting infrastructure.....	60
Conclusion to part 4 .....	64
<b>PART 5. LABOUR PROTECTION .....</b>	<b>66</b>
5.1. Introduction.....	66
5.2. Harmful and dangerous production factors .....	66
5.3. Analysis of working conditions and development of protective measures	70
5.4. Fire safety rules at the workplace .....	71
Conclusion to part 5 .....	72
<b>GENERAL CONCLUSION .....</b>	<b>73</b>
<b>REFERENCES.....</b>	<b>74</b>
Appendix A .....	
Appendix B.....	
Appendix C.....	

## INTRODUCTION

Commercial airlines are an integral part of our everyday transport. According to the Federal Aviation Administration (FAA), there are 23,911 commercial flights per day in the United States only. All airline companies try to keep the aircraft in flight as much as possible and try to minimize time spend on the ground. The extra time of the aircraft spend at the airport decrease the efficiency of the plane and also handling capability of the airport.

An aircraft “turnaround” is a special term for the complex processes which are performed before arriving the aircraft and till the departure. Primary operations for the aircraft turnaround are: handling processes at the stand like deboarding, catering, fueling, cleaning, boarding, unloading, loading. All this processes, except boarding, are controlled by airport or airlines staff, by ground handling.

Aircraft boarding is one of the critical processes in turnaround, because it is difficult to control it, it depends on the passengers’ experience and ability to follow the boarding procedure. Therefore, reducing boarding time can cut down processing time for the most part. Adopting a quick and easy boarding strategy will provide benefits to airlines as well as passengers and airport staff. It increases the utilization of ground equipment and the service level of the airline in general. Inefficient boarding processes directly affect the quality of service and how passengers will rate it.

The purpose of my work is to perform preliminary design of passenger aircraft and to make the layout of passenger aircraft, review different strategies for boarding passengers on an aircraft that can reduce processing time and determine the optimal boarding method.

## **PART 1. PASSENGER TRANSPORTATION REGULATIONS**

### **1.1. The law basics of regulation of passenger transportation by air transport**

Carriage by air is the transportation of passengers and baggage by an aviation company in aircrafts for a fixed fee, as well as by the carrier's ground vehicles.

Internal air transportation is air transportation in which the point of departure, point of destination and all landing points are located on the territory of one state.

International air transportation is air transportation in which the point of departure and point of destination are located: respectively, in the territory of two states; in the territory of one state, if the point (points) of landing in the territory of another state.

Transportation period includes: in passenger transportation - a period of time from the moment a passenger enters an airport apron to board an aircraft and until he leaves the apron under the supervision of authorized persons of the carrier; in baggage transportation - a period of time from the acceptance of baggage for transportation and until its delivery to the recipient or transfer under established rules to another organization. At the same time apron means a part of the civil airfield's flying field intended for accommodation of aircraft for the purpose of embarkation and disembarkation of passengers, loading and unloading of luggage, cargo and mail, as well as for other types of service.

Transportation by air is regulated in accordance with international law (if the transportation is international) or national law (if the transportation is domestic).

Air transportation is performed on the basis of a contract of carriage of passengers, cargo or mail with the carrier.

A carrier is an operator licensed to carry passengers, baggage or mail by air.

According to a contract of transportation by air of a passenger, the carrier is obliged to carry the passenger to the point of destination, providing him with a seat on the aircraft operating the flight specified on the ticket, and if the passenger is carrying baggage by air, to deliver that baggage to the point of destination as well.

The term of delivery of the passenger and baggage is determined by the rules of air carriage established by the carriers.

Passengers are obliged to pay for carriage by air, and for the carriage of baggage above the free baggage allowance established by the carrier.

Every contract of transportation by air and its conditions are certified by documents of transportation issued by the carrier or its agents. Documents of transportation include:

- a passenger ticket - when transporting a passenger. It is a document certifying the conclusion of a contract of transportation by air of passengers and baggage and includes a baggage receipt;
- luggage receipt - part of the ticket in which the number of seats and the weight of the checked-in baggage are indicated and which is issued by the carrier as a receipt for the baggage checked-in by the passenger;
- excess Baggage Ticket - a document confirming payment for excess baggage or items subject to compulsory payment, as well as the payment of charges for the declared value of the baggage;
- air waybill - a document confirming a contract between a shipper and a carrier for the carriage of cargo on the carrier's routes. It is made out by the consignor or his authorized representative.

Compliance with the conditions of the contract of carriage is mandatory regardless of whether it is a regular or a charter carriage. It should be taken into account that the conclusion of a contract for passenger transportation implies the rules:

1. The time of departure indicated in the schedule and ticket is not a binding condition of the contract and is not guaranteed by the carrier. In order to ensure flight safety, the flight may be cancelled, postponed or delayed. The reason for these changes may be bad weather conditions at the airports of departure, arrival or stopping points, natural disasters, disruption of the runway, etc.

2. The Carrier reserves the right to replace the aircraft, change the route of carriage and the landing points indicated in the schedule and on the ticket. This right of the carrier is also justified to ensure passenger safety in case of aircraft breakdown or force majeure situations on the route.

In any of the above cases, the carrier, taking into account the legitimate interests of passengers, is obliged:

- notify them of the schedule change;
- carry out the carriage by its own flight or by the flight of another carrier;
- arrange for service of registered passengers at the airport or provide them with

a hotel in accordance with the established procedure. If the circumstances are such that the passenger is forced to cancel the carriage due to a change in the schedule, the carrier is obliged to refund him the amount of money for the aborted carriage.

3. The carrier has the right to refuse carriage of a passenger if his documents are incorrectly executed or not presented in full. It should be noted that the availability, reliability and accuracy of documents issued by state authorities depend solely on the competence of those authorities and the citizen himself, in connection with which all claims often made in such situations against the carrier by passengers are unfounded. The carrier bears no responsibility for the execution of such documents.

4. Passengers have the right to interrupt their journey and make a stopover at any intermediate airport, as long as it provides for boarding. Having stayed at the boarding point for the time required, the traveler can continue on the route. You can book a seat on a similar flight (if you know the exact date of continuation) or request confirmation of a seat on the flight on the desired date.

5. If the passenger did not declare a stopover at an intermediate airport when purchasing the ticket, but decided to exercise this right during the flight, he can continue to fly after reimbursing the carrier the difference in the fare, as well as losses in case of flight delays due to removal of his baggage from the plane, which was issued before the final destination.

An involuntary stop due to illness of a passenger or family member traveling with the passenger on the flight in progress is an exception and does not require refunds. It should be noted that the right to "Stopover" applies mainly to transportation issued at normal fares. If a passenger has a ticket issued at a special fare, stops along the way are subject to restrictions or are prohibited at all in accordance with the rules of application of this fare.

Passengers are obliged to comply with all laws, regulations, rules and instructions of competent authorities of the state to which or through whose territory they are being

transported. This includes compliance with special control, customs, passport, visa, sanitary and other formalities, as well as the rules and instructions of the carrier.

If the state authorities of the country oblige the carrier to return the passenger to the point of departure or any other point because he has been refused entry into the country of destination, transfer or transit, the passenger or the organization that made him out must reimburse the carrier all expenses incurred in connection with this transportation.

A passenger of an aircraft has the right:

- travel on preferential terms in accordance with international law and the rules of air transportation established by the carrier;
- free baggage allowance (including the items carried by the passenger) within the set norms depending on the aircraft type (not less than 10 kg per passenger);
- free carriage (in case of international air transportation) of a child not older than 2 years old without providing him/her a separate seat. Other children not older than 2 years, as well as children aged from 2 to 12 years are carried at a reduced rate, with the provision of separate seats for free use of restrooms, mother and child rooms, as well as hotel accommodation in case of interruption of air carriage by virtue of the carrier or in case of a forced delay of the aircraft during departure and (or) in flight.

The procedure for the provision of services and benefits to aircraft passengers is established by federal aviation regulations. A contract of transportation by air may be terminated at the initiative of the carrier or the passenger. The Carrier may unilaterally terminate a contract of transportation by air of a passenger in the following cases:

- passenger's violation of passport, customs, sanitary and other requirements established by law in relation to air transportation;
- refusal by a passenger to comply with the requirements set forth by aviation regulations;
- the passenger's health condition, which requires special conditions of transportation by air, or threatens the passenger or other persons, and which is confirmed by medical documents, or creates disorder or unremovable inconvenience for other persons;



- refusal by a passenger to pay for the carriage of his/her baggage, the weight of which exceeds the free baggage allowance;

- refusal by a passenger to pay for the carriage of a child over 2 years old accompanying him/her;

- if a passenger violates the rules of conduct on board an aircraft, and if such violation threatens aircraft flight safety or life or health of other persons, or if a passenger fails to follow the instructions of the pilot in command;

presence in personal belongings of the passenger, as well as in his/her baggage or cargo of items or substances forbidden for carriage by air.

If the contract of transportation by air is terminated on the carrier's initiative, the amount paid for the transportation is refunded to the passenger (except for the case when the passenger violates the rules of conduct on board the aircraft).

Passenger has the right to refuse carriage at the airport or on the way. In this case he may get back the payment for carriage or its unused part from the carrier in the amount stipulated by the fare rules.

Passenger's refusal from carriage may be involuntary or voluntary. Involuntary refusal is a refusal caused by the following circumstances:

- cancellation or delay of the flight indicated on the ticket;

- inability to provide the seat or class of service indicated on the ticket due to a booking error; inability to land at the airport indicated on the ticket due to emergency situations;

- change of aircraft type operating the flight;

- illness of the passenger or of a family member traveling with the passenger;

- Incorrect execution of travel documents by the carrier - the impossibility to depart from the airport of transfer by the flight indicated in the ticket, because of the delay of the aircraft or the cancellation of the flight which the passenger should arrive at the airport of transfer.

If a passenger is forced to refuse carriage, the carrier is obliged to offer him carriage on one of the next flights under the conditions specified in the ticket, or refund the cost of

the ticket without penalties. In this case, if the carriage was not performed on any section, the entire amount paid shall be refunded, and if the carriage was partially performed, the amount for the unperformed part of the carriage shall be refunded.

Special flight safety control is carried out by the airport security service and the carrier. It consists in checking whether passengers and their hand luggage have items prohibited for carriage by air transport (firearms and bladed weapons, ammunition, explosives, flammable, poisonous, toxic, explosive substances, compressed and liquefied gases), and other substances and items that may be accepted for carriage only under special conditions.

The purpose of this type of control is prevention of terrorist acts and hostage-taking on board the aircraft and prevention of illegal export of the above-listed items and substances.

A preflight inspection of passengers and hand baggage is arranged in the special control zone immediately before boarding the aircraft. The special screening area consists of one or two checkpoints equipped with technical screening devices:



Figure 1.1 - X-ray television stationary Introscope's for the control of hand luggage

While checking the hand baggage if the screen shows weapons or other items prohibited for carriage by air transport, the passenger is offered to open the hand baggage and then it is inspected. The same offer may be made to the passenger if the contents of the hand baggage contain items and substances that raise doubts as to their purpose.

If prohibited substances or items are found in the items, which the passenger is trying to smuggle, he/she is held responsible for this in accordance with the established procedure. If during the inspection of a passenger, dangerous substances and items, the manufacture, carrying or storing of which involves criminal liability (weapons, ammunition, explosives, explosive devices, poisonous, narcotic, radioactive substances, etc.) are found, the passenger is removed from the flight and together with the materials (act and confiscated substances and items) is transferred to the internal affairs authorities to address the issue of bringing him/her to responsibility.



Figure 1.2 – Stationary and hand-held metal detectors for passenger screening

In some cases, when transportation of dangerous items is illegal, a safety representative may decide to withdraw these items for the duration of the flight. The fact of confiscation is documented by a special document - a report registered in the journal. At that, dangerous goods and substances withdrawn from a passenger that are on sale but prohibited for carriage on civil aircraft (gas cylinders, gas canisters, flammable paint

products, substances and household items that do not have standard factory packaging, etc.) shall be given to escorts or kept at the airport in special premises.

Before going through preflight check passenger is obliged to put all metal items available with him/her on the examination table and pass through a stationary metal detector. If the passage of a special security checkpoint was satisfactory, an inspector makes a note in the ticket about the passage of the preflight check and the passenger is sent to boarding.

In case the signal of the stationary metal detector is triggered, the inspector searches the passenger with the hand-held metal detector. In the presence of audio signals inspector offers the passenger to go to the cabin with hand luggage, where the personal inspection of the passenger is carried out. The personal search is conducted only by persons of the same sex as the passenger being screened in specially allocated rooms at airports, which meet the requirements of sanitation and hygiene. The simultaneous body search of several passengers is prohibited in one room. During a body search, the persons performing it are obliged to be attentive and polite to the passenger and not to allow actions humiliating his/her dignity. If, as a result of the special safety inspection, the passenger was late for the flight, but no dangerous items were found in his/her belongings, the officials conducting the inspection are obliged to take the necessary measures to send the passenger on the next flight. If the passenger refuses to fly or to continue the flight because of the delay in departure, caused by the inspection, the airline is obliged at his request to fully compensate the cost of the ticket or its unused part.

In case of passenger's refusal to pass inspection or to present items for inspection, the passenger is not allowed for transportation.

## **1.2. Boarding of passengers on board of an aircraft to minimize turn-around time**

The aviation industry is quite capital intensive and its profitability is directly dependent on the efficiency of fuel and aircraft use in general. Given that airlines generate income from transportation only when the aircraft is in the air, the goal of all airlines is to reduce the time that an aircraft spends on the ground. However, minimizing aircraft ground time should not sacrifice safety or endanger the health and lives of passengers. Aircraft

ground time is usually called turnaround time. By definition, this is the time required to deboard passengers, unload the aircraft upon arrival and prepare it for the next flight [1].

Optimization of aircraft utilization also includes efficient, i.e., a shorter aircraft turnaround time. There are two main types of turnarounds: short turnaround model and full turnaround model [2]. The full turnaround model has several different operations that are performed during the turnaround time, most of them simultaneously. However, some operations are included, such as passenger boarding, which cannot be performed simultaneously with others, such as fueling, cabin cleaning and supply loading (unloading), either for safety reasons or for passenger satisfaction. Some operations, such as cabin cleaning and loading of on-board power, are simply not performed in the short turn model, which makes it possible to start the boarding process earlier than during a full turn. In addition, special procedures can be applied for the refueling process, so it can be performed simultaneously with passenger boarding. These procedures include the assistance of the fire crew and the presence of a fire truck during refueling for safety reasons. The model of a full turnaround consists of several different steps (according to the flight requirements), that are shown in Figure 1.3.

All operations that affect the duration of the full turnaround time are called critical [3]. Thus, passenger boarding, as shown in Figure 1.3., is at the so-called critical stage [4] of the turnaround, as it has a huge impact on the progress of other operations. Although boarding is only one stage in the full turnover cycle, it is much easier to change and modify than other operations. Over the past two decades, many different landing strategies have been proposed to improve aircraft utilization and reduce handling times.

From an air transport point of view, a flight can be considered as a "gate-to-gate" or "air-to-air" process: while "gate-to-gate" focuses more on the flight path of the aircraft, the "air-to-air" process concentrates on the ground operations at the airport to allow efficient flight operations and accurate departure times. Typical baseline deviations for "air-to-air" flights are 30 seconds for 20 minutes before arrival [5], but can increase to 15 minutes when the aircraft has still not taken off [6]. As shown in Figure 1.4., the average temporal variation (measured as standard deviation) is higher in the flight phase (5.3 min) than in the takeoff (3.8 min) and taxiing (2.0 min) phases, but is significantly lower than both departure (16.6

min) and arrival (18.6 min) variability [7]. If the airplane departs from the airport, the changes in arrival time are relatively small [8]. Thus, the punctuality of arrival is obviously conditioned by the punctuality of a departure.

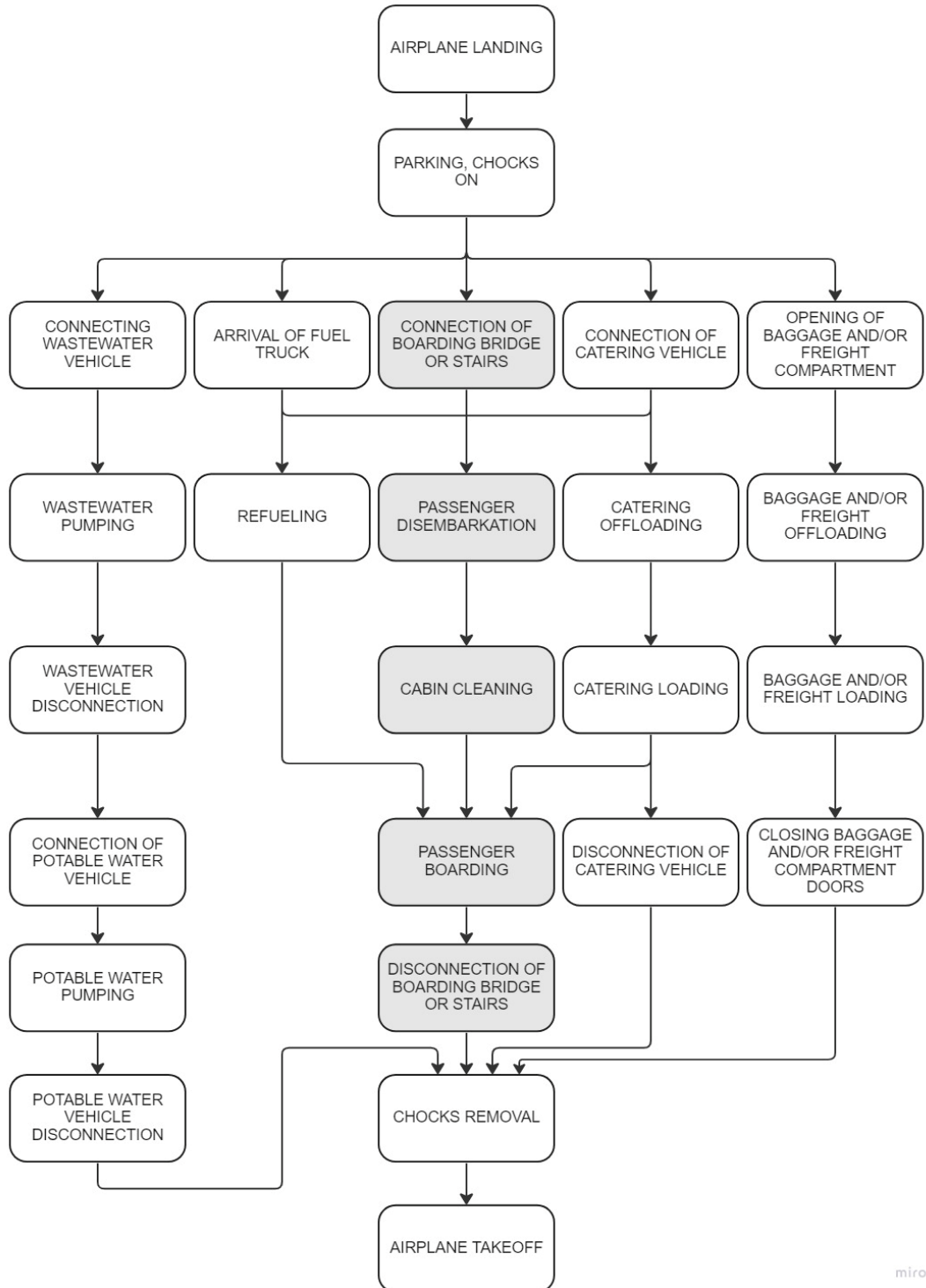

Figure 1.3 – Airplane full turnaround model scheme

The punctuality of all air operations depends on the efficiency of the sides involved in this operation (airline, airport, air network control, air navigation equipment and service provider). In order to achieve the punctuality target, airlines apply so-called time buffers to compensate deviations at the flight level. In 2016, only 80.5 % of flights were on-time (with delays of less than 15 minutes), a percentage that has decreased since 2013, when punctuality was 84 % [7].

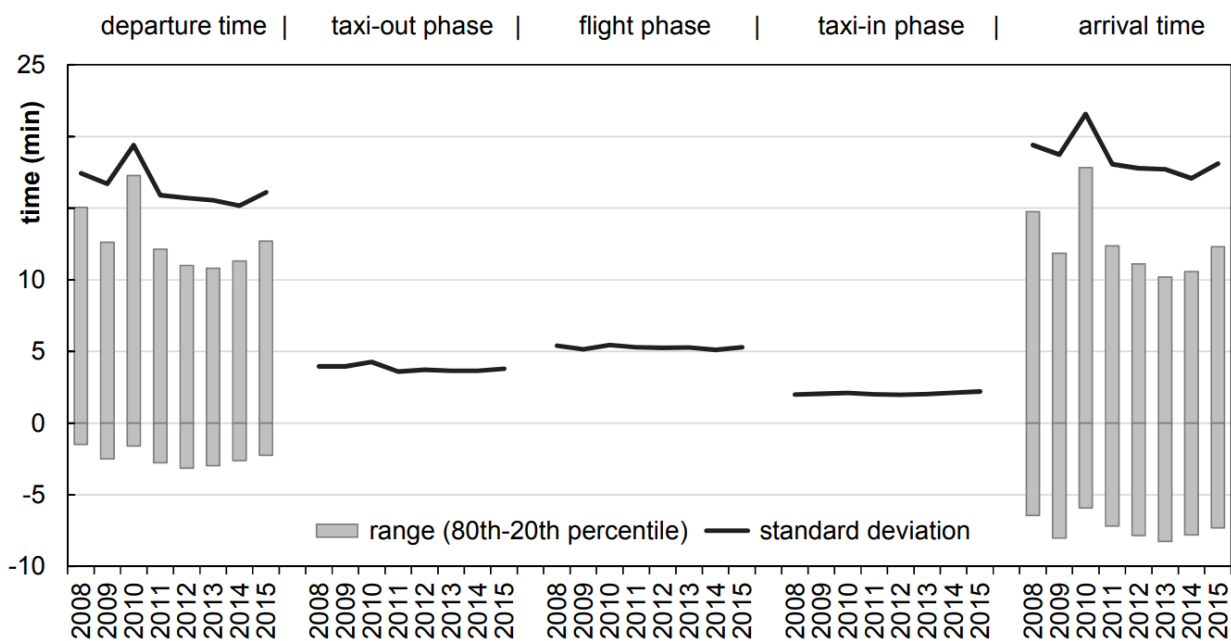

Figure 1.4 - Changeability of ground and flight phases on European flights

In Figure 1.5., the flight delays are reviewed and categorized into four groups of delays: airline delays, reaction delays, travel delays (ATFM - Air Traffic Flow Management), and weather delays (except ATFM, but ATFM delays due to weather conditions at destination). This categorization is based on the IATA standard delay codes as defined in the Airport Service Manual [9]. Airline reasons for delay range from Code 11 "late check-in (passenger and luggage)" to Code 69 "captain's request for a security check". The reaction delay (code 91-96) takes into account the reasons for load connection such as: rotation (aircraft, crew, flight attendants), operation, and check-in error.

The reaction delay begins at 18% and hits a maximum of 66% and 2100 UTC. During this time, airline delays decrease from 37% to 21%. Weather-related and en route delays are

only slightly affected, as evidenced by a relatively stable average share of 8% and 6% respectively. Ground-level delays caused by airlines, passengers, ground handling operators and by other parties represented 35% of all departure delays in 2016, with an average departure time delay per flight of 11.2 minutes [7]. All this requires a sustainable increase in efficiency and predictability of turnover with the support of local initiatives, for example such as APOC (Airport Operations Center) or A-CDM, platforms for interaction and coordination of stakeholders [11].

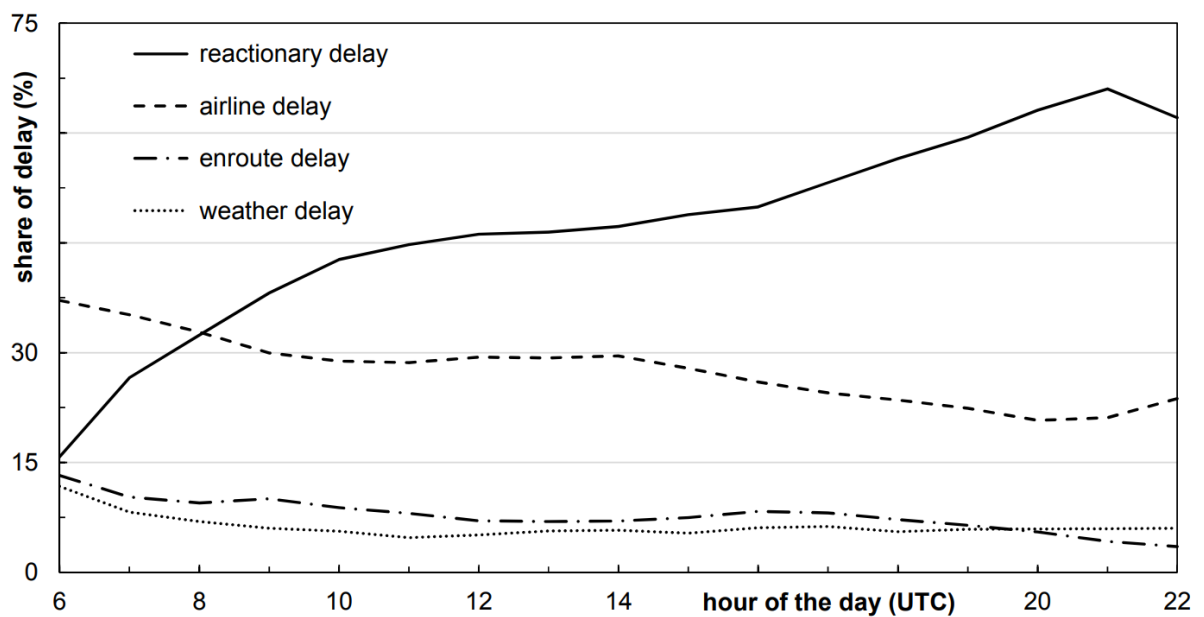

Figure 1.5 – Average departure delay per flight by hour of the day [10]

A complete turnaround consists of five main steps: unloading, cleaning, catering, refueling and boarding, as well as parallel offloading and onloading processes. From the operator's point of view, all these processes of aircraft servicing would follow certain procedures and are mainly controlled by ground handling staff, airport or/and airline [12,13]. As an exception, the boarding procedure may be driven by the passengers' experience and desire or ability to follow the prescribed procedures (e.g., lateness, no-show, quantity of hand luggage, high-priority passengers). To achieve a reliable time mark for TOBT, the critical turnaround path must be under the operational facilities' control. The stochastic and



passenger-controlled boarding process makes it hard to predict processing times reliably, even if boarding is already underway.

### **Conclusion to part 1**

Future 4D aircraft trajectories require comprehensive consideration of ecological, economic and performance constraints, as well as reliable forecasting of all processes related to aircraft. Mutual dependency between airports leads to system-wide, far-reaching consequences in the air traffic network (reaction delays). To overcome airline/airport problems during the day, it is necessary to move to an "air-to-air" approach, paying special attention to aircraft ground operations as a major factor in airlines' punctuality. The ground trajectories of aircraft are mainly composed of the processes of service in the terminal (disembarkation, catering, refueling, cleaning, boarding, unloading, loading), which are determined as aircraft turnover/turnaround. Turnaround operations are mostly controlled by airport, ground handling or airline personnel, with the exception of boarding, which is determined by passenger experience and readiness/ability to follow prescribed boarding procedures.

## **PART 2. PRELIMINARY DESIGN OF THE MID-RANGE PASSENGER AIRCRAFT**

### **2.1. Purpose of the designed aircraft and analysis of prototypes**

Presented thesis are devoted to the conceptual design at the first iteration and a part of preliminary design of mid-range passenger aircraft. The mission of the aircraft is commercial transportation of passengers, baggage, cargo and mail on medium-haul flights. The aircraft design is based on the next main requirements:

- providing the necessary economic efficiency of transportation;
- providing maximum passenger safety;
- providing the necessary environmental conditions for occupants during the flight and maximum comfort and attractiveness (pressurization, galleys, lavatories), ergonomics,
- the choice of specific aerodynamic features is based on the prototypes, (flaps, slats, wing sweep, etc)

As for the requirements to manufacturing, maintenance, cost estimation, evaluation of marketability is not taking into account at this stage of aircraft design process.

During the preliminary stage the main tasks are:

- detailed geometry development
- layout of main parts of the aircraft
- layout of passenger cabin.

The final results of the preliminary design are the drawing package and preliminary design evaluation.

The main prototypes for the designed aircraft are Boeing 737-200, Boeing 727, the operational and technical performances of which are presented in Table 2.1. To determine the initial data of the designed aircraft, we analyze the data of the prototype aircraft.

Table 2.1.

### Operational and Technical Data of Prototype Aircraft

Performance	B-737-200	B-727
Max. payload, kg	19 000	17 400
Number of crew	2	3
Passengers	120	189
Wing loading, kg/m <sup>2</sup>	586	631
Flight range max, km	3100	2780
Cruising altitude range, km	9.5 – 11	9.5 – 11
Max speed, km/h	950	982
Economy speed, km/h	850	883
Number of engines	2 turbofans	3 turbofans
Take-off thrust, kN	119.23	70.3
Cruising thrust, kN	30.2	21
Spec. fuel cons. at take-off, kg/kNh	-	65.8
Specific fuel consumption at cruise flight, kg/kNh	-	85
Compressor pressure ratio	30	18
By-pass ratio	5	1.05
Type of runway	C	B
Approach speed, km/h	244	244
Landing speed, km/h	230	220
Runway length, m	1200	1200
Take-off distance, m	2682	3033
Landing distance, m	1420	1494
Take-off weight, kg	52 390	95 000
Landing weight, kg	46 720	72 575

At the preliminary design phase, the geometry of the main parts of the aircraft is conducted. For the first estimation of the aircraft geometry, the statistical data of prototypes is the origin for all calculations. The geometric characteristics of prototypes are presented in Table 2.2.

Table 2.2.

### Geometric parameters of prototypes

Parameter	B-737-200	B-727
Wing span, m	28.35	32.92
Sweep back angle of $\frac{1}{4}$ of the chord	35	32
Mean aerodynamic chord, m	4.6	5.7
Wing aspect ratio	8.99	7.2
Wing taper ratio	2.94	2.91
Fuselage length, m	30.48	41.51
Fuselage diameter, m	3.88	4
Fuselage fineness ratio	7.61	10.38
Passenger cabin length, m	20.88	28.25
Passenger cabin width, m	3.52	3.56
Cab height, m	2.18	2.11
Cabin volume, m <sup>3</sup>	131.3	188.3
Volume of luggage compartments, m	24.76	43.1
Seat pitch, m	0.762	0.762
Aisle width, m	0.46	-
Horizontal tail (HT) span, m	10.97	10.9
Sweep of the HT along $\frac{1}{4}$ of the chord	35	35
Relative area of the HT	0.322	0.232
Aspect ratio of HT	4.18	3.4
Taper ratio of HT	2.75	2.67
Height of vertical tail (VT), m	6.3	5.1
Sweep angel VT of $\frac{1}{4}$ of the chord	45	55
Relative area of VT	0.233	0.219
Wheel base, m	11.4	19.28
Wheel track, m	5.26	5.72

## 2.2. The choice of the main parameters of the aircraft

The aircraft scheme is determined by the relative arrangement of the units, their quantity and shape. The aerodynamic design and aerodynamic layout of an airplane determine its aerodynamic and technical-operational properties.

Successfully selected scheme can improve the safety and frequency of flights, as well as the economic efficiency of the aircraft. The choice of the layout of the designed aircraft is presented as analysis of the aircraft layout adopted as a prototype.

The airplane is designed as a low wing position plane. This aircraft is designed according to the normal scheme, that is, the horizontal tail is located behind the wing. This scheme is widespread in civil aviation. The main advantages of a normal scheme are:

- the possibility of effective usage of wing high lift devices;
- easy balancing of the aircraft;
- placement of the tail unit behind the wing, allowing the fuselage nose part to be shorter, which not only improves the pilot's visibility, but also reduces the vertical tail area, since the shortened fuselage nose part causes less destabilizing momentum;
- the possibility of reducing the areas of vertical tail and horizontal tail, because the arms of vertical and horizontal tail are much larger than those of other schemes.

When selecting the position of the engines take into account the characteristics of the overall arrangement of the aircraft, operating conditions and to ensure maximum engine thrust to obtain the less drag and to minimize air losses in the air intake. In this scheme of the aircraft engines are placed under the wing on the pylons, which provides the advantages. One of the disadvantages of this arrangement of engines on the wing is that the diameter of the engine increases with the degree of bypass ratio. Therefore, when arranging the engines under the wing, it is necessary to increase the height of the landing gear to ensure the normalized distance from the nacelle outline to the ground surface.

The projected aircraft has a tricycle landing gear scheme with a nose wheel. This scheme of landing gear provides the aircraft with high stability at the takeoff and landing, good controllability during taxiing and effective wheel braking. Aircraft with such landing gear scheme have horizontal longitudinal axis position both when parked and when moving on the airfield, so pilots have better view from the cockpit and increased comfort for passengers. Tricycle landing gear layout can greatly simplify aircraft takeoff and landing in crosswinds by making nose wheel self-orienting and equipped them with shimmy dampers.

The most important task in aircraft design is to reduce fuel consumption as much as possible, both through aerodynamic layout and through a choice of propulsion system type.

At this stage, the quantity of engines is set according to statistical data, taking into account the degree of pressure boost of the prototype aircraft engines. For the designed

aircraft, we accept the following parameters of two turbojet engines with a thrust capacity of 2.8 N/kg with a degree of pressure increase of 35, the bypass ratio 5.5.

The basic parameters of the wing include the type of airfoil and its relative thickness, the sweep  $\chi$  by 0.25 chords, aspect ratio  $\lambda$ , taper ratio  $\eta$ , dihedral angle  $V$  of the wing and the wing specific load  $P$ , and the wing shape in profile.

The wing aspect ratio is a parameter that significantly affects the value of induced drag and the aerodynamic quality of the wing and the aircraft at all. In addition,  $\lambda$  affects the weight and stiffness characteristics of the wing structure.

Subsonic transport aircraft have wings with zero and small sweep. The aspect ratio of wing is in range of  $\lambda = 8 \dots 12$ , with high values of aspect ratio applied to large-size aircraft with a long flight range. Higher values of wing aspect ratio are sometimes chosen for aircraft with a short range due to the desire to improve their takeoff and landing characteristics.

Wing taper ratio has a controversial effect on the aerodynamic, weight and stiffness characteristics of the wing. Increasing the taper ratio  $\eta$  has a positive effect on the distribution of external loads, stiffness and weight characteristics of the wing. It also leads to an increase in the construction height and volume of the central part of the wing, which makes it easier to place fuel and various units, and an increase in the wing area serviced by mechanization significantly increases its efficiency.

However, increasing the constriction also has negative sides. The main one is the tendency of a wing with a large contraction to end-stripping of the flux with simultaneous reduction of aileron efficiency. In connection with the above circumstances, the taper ratio of straight wings of subsonic airplanes is usually small and makes up  $\eta = 2 \dots 2.5$ , which ensures close to a minimum inductive resistance of the wing and high values of  $C_{Y_{\max \text{ pos}}}$ .

The dihedral angle of the wing serves as a tool to ensure the degree of transverse stability of the aircraft. Its magnitude and sign depend in an eye-catching way on the scheme of the aircraft, and for aircraft with swept wings - also on the angle of sweep. For straight wings of subsonic aircraft, the dihedral angle ranges from  $+ 5^\circ \dots 7^\circ$  for a low-plane configuration to  $-1^\circ \dots -2^\circ$  for a high-plane configuration. The sweep increases the transverse stability of the wing and, therefore, swept wings should be given an anhedral angle.

However, layout and other requirements (e.g., landing with a roll) may result in a positive  $V$  of the swept wing. This would cause automatic yaw dampers to be installed in the control system and would require some increase in the vertical tail area.

We choose the following basic parameters of the wing:

$$\lambda = 9; \eta = 2.8; C = 0.11; \chi_{0.25} = 28^\circ.$$

The aerodynamic and weight characteristics of the fuselage essentially depend on its shape and dimensions, which are determined by such geometrical parameters as cross-sectional shape, fineness ratio  $\lambda_f$  and fuselage diameter  $D_f$ . It should be noted that the fuselage fineness ratio and length are specified when the aircraft is subsequently configured to ensure the necessary volumes for accommodating the crew, passengers and cargo, as well as the acceptable shoulders  $L_{VTU}$  and  $L_{HTU}$  of the horizontal and vertical tail unit of the aircraft. The fineness ratio of the fuselage and its parts (nose  $\lambda_{vt}$  and tail  $\lambda_{ht}$ ) is selected from aerodynamics and fuselage weight considerations.

Their final values are specified when making the layout drawing of the fuselage. The diameter of the fuselage of passenger aircraft is mainly determined by the number of passenger seats placed in one row and the class of the passenger cabin, which determines the width of seats with armrests, as well as the width and number of aisles.

A preliminary estimation of the fuselage diameter should be performed based on statistical data and prototype parameters. We choose the following main parameters of the fuselage:  $D_f = 3.9$  m,  $\lambda_f = 9.2$ .

### **2.3. Brief description of the designed airplane**

The projected aircraft is a free-floating low-plane with two turbojet engines placed in the nacelles under the wings, with a three-axis chassis scheme with a nose support.

The wing of the aircraft is trapezoidal, of great elongation with a supercritical wing profile. The leading edge of the wing is equipped with retractable leading flaps; the trailing edge has three-slit flaps and slot ailerons with axial compensation.

### 2.3.1. Fuselage design

The fuselage has round cross-section. The tail unit has fin and fixed stabilizer mounted at the tail of the aircraft.

The fuselage is an all-metal semi-monocoque design with a longitudinal set of stringers and longerons, a transverse set of forms and frames and working skin with reinforcements in the areas of cutouts for hatches, doors, equipment of the aircraft.

The fuselage is conventionally divided by length into forward, middle, and tail parts.

In the forward part of the fuselage is a cockpit, which is separated by a partition from the passenger cabin. In the front part of the cockpit there is a window porthole, in the upper part there is an escape hatch. Entrance to the cockpit is carried out from the passenger cabin by stairs, through the hatch in the floor of the cockpit. Under the cockpit floor there is a technical compartment with a wheel well for nose landing gear, closed by doors, and a shaft with a lower escape hatch that can be opened outward.

Cockpit windows and the design of nose part of cockpit provide adequate visibility for pilots in flight. Windshields and their mounting visors can withstand normalized bird strike.

The circular cross-section of fuselage is the most efficient because it provides the minimum weight and maximum strength, meeting strength requirements and reducing weight are important for aircraft design.

The geometrical parameters, such as: fuselage diameter, length of fuselage, fineness ratio of fuselage, nose part and tail unit geometry are calculated for the designing aircraft. We design the length of the aircraft fuselage by considering the aircraft purpose, number of passengers, cabin layout, and characteristics of the aircraft's center of gravity position and the landing angle of attack.

$$L_{fus} = FR_f * D_{fus} = 9.2 * 3.9 = 35.88 [m];$$

where FR – fineness ratio of the fuselage,

$D_{fus}$  – diameter of the fuselage.



The cabin width of passenger aircraft in a place where we have passenger's seats can be found by the formula:

$$B_{cabin} = n_2 b_2 + n_3 b_3 + n_{aisle} b_{aisle} + 2\delta + 2\delta_{wall}$$

$n_2$ ;  $n_3$  – number of blocks of seats with 2 or 3 seats in a cross section;

$b_2$ ;  $b_3$  – width of block of 2 seats or 3 seats, mm;

$n_{aisle}$  – number of aisles;

$b_{aisle}$  – aisle width, mm;

$\delta$  – distance between external armrests to the decorative panels, mm; minimum 50 mm for the 1<sup>st</sup> class, minimum 30 mm for others classes.

$\delta_{wall}$  = 80...120 mm – width of the wall (fuselage structure, insulation, decorative panels).

The appropriate width of economic class cabin:

$$B_{cab} = n_3 * b_3 + n_{aisle} b_{aisle} + 2\delta + 2\delta_{wall};$$

$$B_{cab} = 2 * 1420 + 1 * 500 + 2 * 200 = 3800 [mm];$$

Aisle width is defined in FAR 25.815. According to the recommendations and on the base of statistic data of prototypes the width of aisle can be taken the 400 mm.

After the definition of the cabin width, we should define the height of the cabin, which is also very important for the comfort. For domestic and short-long range passenger aircraft the minimum height of the cabin is 1950 mm.

The passenger seats are installed along the length of the passenger cabin with correct seat pitch, which depend on the flight duration and class of the cabin. Seat pitch must be divisible to one inch (25,4 mm).

Cabin length  $L_{cab}$  for typical accommodation with constant seat pitch  $L_{seat}$

$$L_{cab} = L_1 + (N-1)L_{seat} + L_2$$

$L_1$  – distance from the wall to the back of the seat in first row, mm;

$L_2$  - distance from the back of the seat in the last row to the wall, mm.

The length of economic passenger cabin:

$$L_{econ} = 1200 + (25 - 1) * 870 + 250 = 22330 [mm];$$

Baggage compartments are placed under the floor of passenger cabin. It is important in the flight which will influence gravity center of the aircraft. Incorrect placement of cargo and passengers, can lead to emergency situations in flight, that is why we have to calculate exactly cargo placement and limit their weight.

Given the fact that the unit of load on floor  $K = 400 \dots 600 \text{ kg/m}^2$

The area of cargo compartment is defined:

$$S_{cargo} = \frac{M_{bag}}{0.4K} + \frac{M_{cargo\&mail}}{0.6K} = \frac{20 \cdot 120}{0.4 \cdot 600} + \frac{15 \cdot 120}{0.6 \cdot 600} = 15 \text{ m}^2$$

$M_{bag}$  – mass of baggages of all passengers,  $M_{bag} = m \cdot n_{pass}$ ,  $m$ - mass of baggage for one passenger for free,  $n_{pass}$  – number of passengers.

$M_{cargo \& mail}$  – mass of additional cargo and mails on the board of aircraft., approximately 15 kilograms for each passenger.

Cargo compartment volume is equal:

$$V_{cargo} = v \cdot n_{pass} = 0.2 \cdot 120 = 24 \text{ m}^3$$

Luggage compartment design similar to the prototype

International standards provide that if the plane made a mixed layout, be sure to make two dishes. If flight duration less than 3 hours the food to passengers is not issued in this case providing only water and tea.

Tickets to the flight time less than one hour, buffets and toilets cannot be done.

Kitchen cupboards and must be placed at the door, preferably between the cockpit and passengers or cargo, have separate doors.

Refreshment and food cannot be placed near the toilet facilities or connect with wardrobe.

According to international standards, the volume of the galleys should be about 0.1 cubic meter per passenger, so the volume of galley should be:

$$V_{galley} = 0.1 * n_{passenger} = 0.1 * 120 = 12 [m^3];$$

The total area of galley floor:

$$S_{galley} = \frac{V_{galley}}{H_{cab}} = \frac{12}{1.5} = 8 [m^2];$$

If food organized once it is given a set number 1 weighing 0,62 kg. Food passengers appears every 3.5...4 hour flight.

Number of meals per passenger breakfast, lunch and dinner – 0.8 kg; tea and water – 0.4 kg, the total weight of food for passenger and crew number is about 148.8 kg.

Buffet design similar to prototype.

Number of toilet facilities is determined by the number of passengers and flight duration: with  $t > 4:00$  one toilet for 40 passengers,

$t = 2 \dots 4$  hours and 50 passengers

$t < 2$  hours to 60 passengers.

$$t = \frac{Range_{flight}}{V_{cruise}} + 0.5 = \frac{5200}{828} + 0.5 = 6.78 [h]$$

$$N_{lavatory} = \frac{N_{passenger}}{40} = \frac{120}{40} \geq 3;$$

The number of lavatories I choose according to the original airplane and it is equal 3.

Area of lavatory:  $S_{lav} = 1.5m^2$

Width of lavatory: 1m. Toilets design similar to the prototype.

On my aircraft, 2 galleys and 3 lavatories are designed. Galley and lavatory design are similar to the prototype, galley and lavatory layout are shown in the layout drawings.

### **2.3.2. Wing design**

The designed aircraft is made by the low-plane scheme, which from the point of view of aerodynamics and layout is the least advantageous, because in the connection zone of the wing with the fuselage, smooth flow and there is additional resistance through the interference of the "wing-fuselage" system. This disadvantage can be significantly reduced by setting the fillets, providing a diffuser effect. The need to maintain a higher fuselage position in the "low-plane" aircraft is associated with the condition of not touching the wing tip when landing with a roll, the runway surface, as well as with the provision of safe operation of the control system when the engines are placed on the wing.

The low-plane design is most often used for passenger aircraft because it provides greater safety, compared to other variants, for emergency landings on the ground and water. When landing on the ground without landing gear retracted, the wing absorbs the impact energy, protecting the passenger cabin. When ditching, the airplane lands onto water up to the wing, which gives additional floatation to the fuselage and simplifies the organization of work related to the evacuation of passengers.

An important advantage of the low-plane scheme is the lowest weight of the structure, because the main landing gear supports are often connected to the wing and their dimensions and weight are smaller than in the high-plane.

Each cantilever part includes: central wing section; outer wing section; fixed nose section; fixed tail section; wing tip; wing torsion box - double-spar design, made of high-strength aluminum alloy, fittings to the fuselage; propulsion system mounting brackets; centre wing section and outer wing section joints; flap mounting assemblies; slat mounting assemblies; spoilers mounting assemblies; aileron mounting assemblies.

The torsion box of a wing is fuel tanks inside. The fasteners that connect the components of the structure provide a tight seal. The system of sealing covers of inspection manholes is made easily replaceable and does not require additional application of sealant.

The middle part of the wing includes: torsion box; non-removable nose bays; non-removable tail bays.

The torsion box includes: front and rear spars; upper and lower panels of monocoque skin structures; set of ribs, and hinges of high lift devices attached to the spars and reinforced ribs in current cross-section.

Each outer wing section includes: a load-bearing torsion box; a fixed nose section; a fixed tail section; a removable wingtip.

The design of the winglet and slats is prefabricated and riveted.

The nose part of the wing is of prefabricated construction, consisting of panels of three-layer construction with using of polymer composites and longitudinal beams.

The tail section of the wing includes: the tail section of the wing; flaps; ailerons; spoilers. The tail section of the wing consists of upper and lower panels of three-layer polymer composites construction.

The flaps are sliding, double-slotted flaps. The flap section includes the main and tail links. Ailerons are made in the form of a prefabricated structure using polymer composites constructions. The spoilers are made of polymer composites.

During the preliminary design stage, the usual practice is to choose the airfoil from the large number of airfoils whose geometric and aerodynamic characteristics are available in the aeronautical literature.

1. Wing airfoil: For designing aircraft supercritical airfoil was taken.
2. Relative thickness of the airfoil is 0.110.
3. Location of the wing on fuselage: low-wing
4. Aspect ratio of the wing  $\lambda_w = 9.00$ ;
5. Taper ratio of the wing  $\eta_w = 2.80$ ; The taper ratio influences the following quantities: induced drag, structural weight, ease of fabrication.
6. Sweep back angle of a wing is 28 degrees.
7. Wing area:

Wing area ( $S_{wing}$ ): This is calculated from the wing loading and gross weight which have been already decided, (in appendix A)

$$S_{wing} = \frac{m_0 \cdot g}{P_0} = \frac{82992 \cdot 9.8}{4.705 \cdot 10^3} = 173 \text{ m}^2$$

Where  $m_0$  – take off mass of the aircraft;

$g$  – gravitational acceleration,

$P_o$  – wing loading at cruise regime of flight.

After the calculation, we compare the area of our wing with a wing area of prototypes and if it necessary we could recalculate it.

So, we take the wing area  $S_{wing} = 252 \text{ m}^2$ .

8. Wing span is:

$$l = \sqrt{s_{wing} \cdot \lambda_w} = \sqrt{173 \cdot 9} = 39.5 \text{ m}$$

9. Root chord is:

$$C_{root} = \frac{2S_w \eta_w}{(1 + \eta_w) \cdot l} = 5,87 \text{ m}$$

10. Tip chord is:

$$C_{tip} = \frac{C_{root}}{\eta_w} = 2.1 \text{ m}$$

11. On board chord for trapezoidal shaped wing is:

$$C_{board} = C_{root} \cdot \left(1 - \frac{(\eta_w - 1) \cdot D_f}{\eta_w \cdot l_w}\right) = 5,87 \cdot \left(1 - \frac{(2.8 - 1) \cdot 3.9}{2.8 \cdot 35.9}\right) = 5,46 \text{ m}$$

12. Wing construction and spars position.

To choose the structure scheme of the wing it is necessary to determine the type of its internal design. The torsion box type with three spars was chosen to meet the requirements of strength and at the same time to make the structure comparatively light.

Relative coordination of the spar's position is equal: for a wing with two spars:  $x_{1spar} = 0.2 C_i$ ;  $x_{2spar} = 0.6 C_i$  from the leading edge of current chord in the wing cross-section,

The spars are shown at the drawing (appendix B).

### 13. Mean aerodynamic chord definition.

The geometrical method of mean aerodynamic chord determination has been taken, which is presented at Figure 2.1.

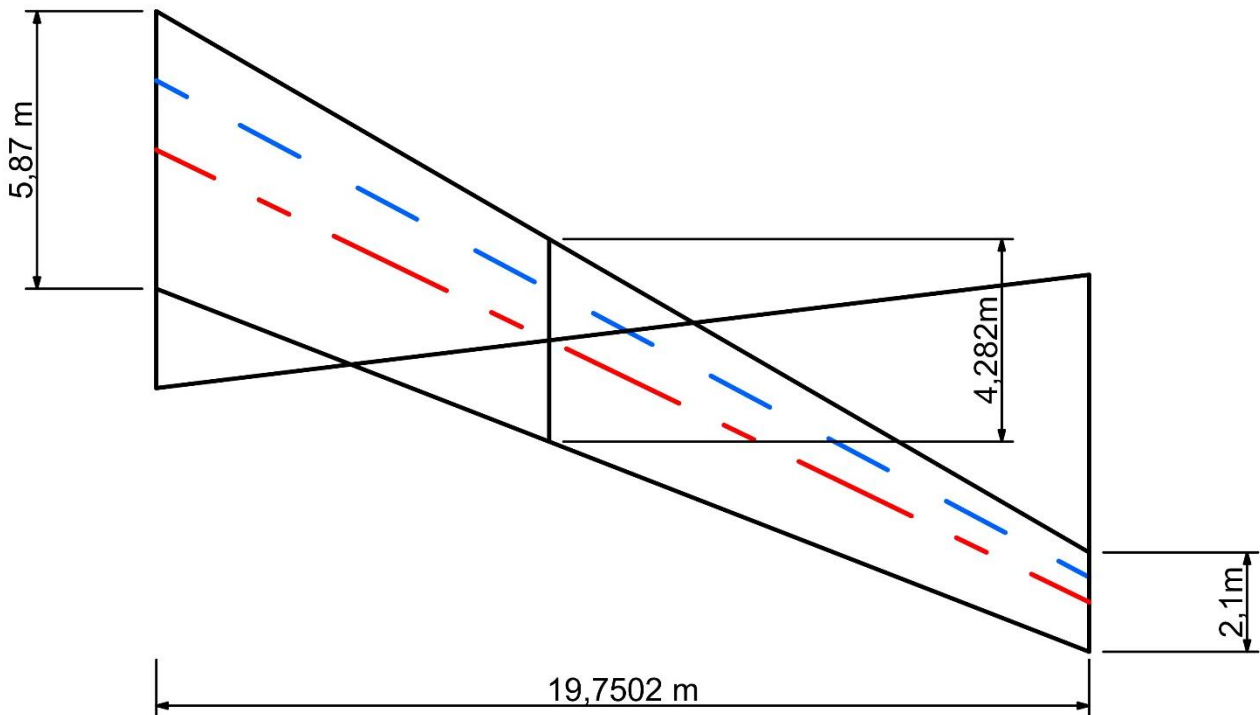

Figure 2.1. – Determination of mean aerodynamic chord

Mean aerodynamic chord is equal  $b_{MAC} = 4.282 \text{ m}$ .

After determination of the geometrical characteristics of the wing we could come to the estimation of the aileron's geometry.

The main purpose of the ailerons is to create rolling moment and provide adequate rate of roll. Ailerons geometrical parameters are determined by the next formulas:

$$\text{Ailerons span } l_{aileron} = (0.3..0.4)l_{wing}/2$$

$$\text{Ailerons chord } C_{aileron} = (0.22..0.26)C_i$$

$$\text{Aileron area } S_{aileron} = (0.05..0.08)S_{wing}/2$$

Ailerons are equipped by the secondary control surfaces (aerodynamic balance). Area of aileron's trim tabs of the aircraft with two engines:  $S_{trim \ tabs} = (0.04..0.06) S_{aileron}$ .

Range of aileron deflection: upward  $\delta_{aileron} \geq 25^\circ$  downward  $\delta_{aileron} \geq 15^\circ$

So, the results are:

$$\text{Aileron's span: } l_{\text{aileron}} = 0.35 \frac{l_w}{2} = 6.3 \text{ m}$$

$$\text{Aileron area: } S_{\text{aileron}} = 0.06 \frac{S_w}{2} = 5.19 \text{ m}^2$$

The relative coordination of high-lift devices on the wing chord are:  $C_f = (0.28..0.3)$   
 $C_i$  – for one slotted and two slotted flaps.

### 2.3.3. Tail unit design

The tail unit of the airplane is made free-bearing, in the classical scheme with one centrally located fin.

The stabilizer is made mainly of composite materials (CM) and consists of: an all-molded frame made of CM with external three-layer panels; nose and tail parts; riveted design. The elevator is two-link, two-section and made mainly of CM. There are removable covers for design inspection, repair and maintenance, as well as replacement of all mechanical parts along the rudder hinge assemblies.

The fin is made primarily of composite materials and consists of: an all-molded frame of CM with external triple-layer panels; the nose; the tail; and the equipment cowl.

The connection between the fin and the fuselage is made by fittings, which are made by machining of aluminum alloy forgings.

The tail unit is protected from degradation or loss of strength when exposed to the environment under all expected operating conditions, and there is ventilation and drainage in all compartments.

Usually, the areas of vertical  $S_{\text{VTU}}$  and horizontal  $S_{\text{HTU}}$  of TU is:

$$S_{\text{HTU}} = (0.18..0.25)S;$$

$$S_{\text{VTU}} = (0.12..0.20)S;$$

For more exact:

$$S_{\text{HTU}} = (b_{\text{mac}} \cdot S) / L_{\text{HTU}} \cdot A_{\text{HTU}}$$

$$S_{\text{VTU}} = (l \cdot S) / L_{\text{VTU}} \cdot A_{\text{VTU}}$$



Where  $L_{HTU}$  and  $L_{VTU}$  - arms of horizontal TU and vertical TU.

$l, S$  – wing span and wing area.

$A_{HTU}, A_{VTU}$  – coefficients of static moments, values of which may be taken from the table.

Values  $L_{HTU}$  and  $L_{VTU}$  depend on some factors. First of all, their value is influenced by the length of the nose part and tail part of the fuselage, sweptback and wing location, and also from the conditions of stability and control of the airplane.

In the first approach we may count that  $L_{HTU} \approx L_{VTU}$  and we may find it from the dependences: Trapezoidal scheme, normal scheme  $L_{VTU} = (0.2..3.5) b_{mac}$

Determination of the elevator area and direction:

$$S_{el} = (0.3..0.4) S_{HTU}$$

Rudder area:

$$S_{rudder} = (0.2..0.22) S_{VTU}$$

The area of aerodynamic balance.

$$S_{ab\ el} = (0.22..0.25) S_{el}$$

$$S_{ab\ rudder} = (0.2..0.22) S_{rudder}$$

Determination of the TU span. TU span is related to the following dependence:

$$l_{HTU} = (0.32..0.5) l_{wing};$$

In this dependence the lower limit corresponds to the turbo jet engine aircraft, equipped with all-moving stabilization.

The height of the vertical TU is determined accordingly to the location of the engines. Taking it into account we assume:

$$\text{Low wing, EonW, } M < 1 \quad h_{VTU} = (0.14..0.2) l_w$$

Tapper ratio of horizontal and vertical TU we need to choose:

For planes  $M < 1$   $\eta_{HTU} = 2..3$   $\eta_{VTU} = 1..1,33$

TU aspect ratio we may recommend:

For transonic planes  $\lambda_{VTU} = 0.8..1.5$ ,  $\lambda_{HTU} = 3.5..4.5$

Width/chord ratio of the airfoil. For horizontal and vertical TU in the first approach, for more accurate 0.08..0.10. If the stabilizations fixation is on the fin we need to use upper limit of it to provide fixation base on the fin.

TU sweptback is taken in the range  $3..5^\circ$ , and not more than wing sweptback. We do it to provide the control of the airplane in shock stall on the wing.

#### **2.3.4. Landing gear design**

The projected aircraft has a tricycle landing gear scheme with a nose support. Such a landing gear scheme provides the aircraft with high stability on takeoff and runway, good controllability when driving on the ground and effective wheel braking. Aircraft with such landing gear scheme have horizontal longitudinal axis position both when parked and when moving on the airfield, so pilots have a better view from the cockpit and increased comfort for passengers.

The landing gear of the aircraft consists of two under wing main supports and one nose support. Each main support is made up of four wheels with hydraulic disc brakes and a wheel cooling system. The main supports retract into the fairing compartments in the direction of the plane of symmetry of the aircraft. When retracted, the wheels of the main supports are automatically braked.

The nose support consists of a steerable strut with two non-braked wheels. The front support is retracted into the front landing gear compartment of the fuselage.

The undercarriage retraction and release system provide:

- retracting and releasing the landing gear in main operating mode;
- release of struts and closing of landing gear compartment doors in standby mode;
- release of the props and closing of the main support pivots by means of the hydromechanical system;

- signal to the braking system for braking the wheels the main landing gear retracts (post-flight braking);

- retracting with incomplete release and release with incomplete retracting cycle.

The system is designed to lock the landing gear retraction on the ground when the shock absorbers are compressed.

Retracting and releasing the nose support and main landing gear supports are performed from separate electrohydraulic subsystems.

In case of failure of the main and reserve modes of landing gear release, provides: hydromechanical release of the main landing gear struts, mechanical release of the nose support, mechanical closure of the main landing gear compartment flaps.

The wheel braking system is designed for braking during parking and taxiing. The wheel braking system is of the electro-hydromechanical type, with anti-braking automatics of continuous-discrete action and a built-in automatic performance monitoring system.

In the primary stage of design, when the airplane center-of-gravity position is not defined and there is no drawing of airplane general view, only the part of landing gear parameters may be determined.

The distance from the centre of gravity to the main LG

$$B_m = (0.15..0.20)b_{MAC},$$

With the large distance the lift of the nose gear during take off is complicated, and with small, the strike of the airplane tail is possible, when the loading of the back of the airplane comes first. Besides the load on the nose LG will be too small and the airplane will be not stable during the run on the slickly runway and side wind.

Landing gear wheel base comes from the expression:

$$B = (0.3..0.4)l_f = (6..10)B_m = 12.56 \text{ m}$$

Large value belongs to the airplane with the engine on the wing.

The last equation means that the nose support carries 6..10% of aircraft weight.

The distance from the center of gravity to the nose LG:

$$B_n = B - B_m = 11.71 \text{ m}$$

Wheel track is:

$$T = (0.7..1.2)B \leq 12\text{m} = 5.7 \text{ m}$$

On a condition of the prevention of the side nose-over the value T should be  $> 2H$ , where H – is the distance from runway to the center of gravity.

Wheels for the landing gear is chosen by the size and run loading on it from the take-off weight; for the front support we consider dynamic loading also.

Type of tires and the pressure in it is determined by the runway surface, which should be used. We install breaks on the main wheel, and sometimes for the front wheel also.

The load on the wheel is determined:

$$F_{main} = \frac{(B - B_m)m_0 \cdot 9.81}{B \cdot n \cdot z} = 189634.73 \text{ N}$$

$$F_{nose} = \frac{B_m \cdot m_0 \cdot 9.81 \cdot K_g}{B \cdot z} = 41086.98 \text{ N}$$

Where n, and z – is the quantity of the supports and wheels on the one leg.

$K_g = 1.5..2.0$  – dynamics coefficient.

By calculated  $F_{main}$  and  $F_{nose}$  and the value of  $V_{take\ off}$  and  $V_{landing}$ , pneumatics is chosen from the catalog, the following correlations should correspond.

$$P_{slmain}^K \geq P_{main}; P_{slnose}^K \geq P_{nose}; V_{landing}^K \geq V_{landing}; V_{takeoff}^K \geq V_{takeoff}$$

Where K is the index designated the value of the parameter allowable in catalog. For ensuring of airplane pass ability, used on the ground runways, pressure in the wheel pneumatics should range in  $P=(3..5)10^5$ , [Pa]. From the catalog of Michelin select the following wheels: the base support - H44.5x16.5-21/28PR in inches (brake); H44 - wheel diameter in inches, which corresponds to 1117.6 mm, 16.5-inch wheel width - 419 mm, 21 inch = 533.4 mm rim diameter, 28 Ply rating - marking the tire. Nose support - 27x7.75-R15/12PR/225Speed Mph (non-braked).

### 2.3.5. Engine selection

For the designed aircraft, we choose the CFM56-7BE turbofan engine produced by CFM International (an association of the American private company General Electric and the French company SNECMA), the specifications of which are given in Table 2.3.

*Table 2.3.*

**Technical characteristics of CFM 56-7 BE engines**

Characteristics	CFM 56 - 7 BE
Thrust, kgs	14165
Degree of dual circuit	6.60
Total degree of pressure rises	31.5
Air consumption, kg/sec	466
Thrust, kgs	2996
Specific fuel consumption, (kg/h)/kgs	0.545

### Conclusion to part 2

In this section of the thesis the following was done: analysis of prototype airplanes and selection of the main parameters of the airplane; with the help of a computer program developed at the Department of Aircraft Design, calculations of the main flight and technical characteristics of the aircraft were made, all the results of which are presented in Appendix A; the basic geometric parameters of the main parts of the designed aircraft were selected; obtained the basic geometric parameters of the main parts of the designed aircraft; selection of engines, specifically CFM56; passenger cabin layout, consumer equipment layout.

As a result of a certain number of comparative calculations, computational and research work the aircraft was designed to meet the requirements of aviation engineering, safety, practicality and economy.

### PART 3. AIRCRAFT BOARDING STRATEGY

There are various ways to significantly improving the boarding process: introducing more sophisticated boarding procedures (it can be as random boarding, as individual seat assignment), baggage grouping or dynamic seating approaches, using of a second door, reducing the amount of carry-on luggage and infrastructural modifications.

I will consider different strategies for individual seat assignment (also with the possibility of using a second entrance) and try to find the most optimal ones in my opinion.

I will be using a presented in second part of the thesis mid-range passenger aircraft to look at different strategies for boarding passengers. In this modification it has 20 rows of 6 seats each, one aisle that divides the row into 2 parts of 3 seats each, and all seats will be economy class for ease of calculation. There are also two passenger entrances on this aircraft (see Figure 3.1).

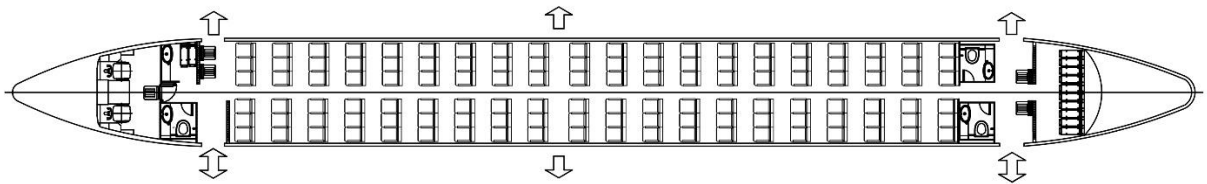

Figure 3.1 – Boeing 737 passenger seats layout

The passenger compartment is divided into utility areas and seating areas. The equipment and furnishings which are installed in the seating areas are economy class passenger seats and cabin attendant seats, linings and furnishings that cover the compartment structure, overhead storage bins, passenger service units. As for the utility areas: cabin attendant seats, passenger service units, equipment, galleys, lavatories.

In the lower deck of the aircraft, there are two lower baggage holds: the forward cargo compartment and the aft cargo compartments.

Emergency equipment is composed of fire protection and emergency oxygen equipment, cockpit and cabin escape facilities, floatation and survival equipment, evacuation signaling equipment, rapid decompression system.

### 3.1. Methods for boarding a commercial airplane

The passenger boarding procedure consists of a set of simple rules [14]:

- enter the aircraft through the assigned door;
- move ahead along the aisle till you reach the desired row of seats;
- put your hand luggage in the overhead compartment and sit down.

This at first sight simple process can be complicated by adding additional variables, such as: more entry points (rear, front, and, sometimes, if the aircraft configuration allows, entry in the middle); more aisles in the cabin; restrictions (or lack thereof) on the amount of hand luggage, etc.

There is also the possibility of a strategy of occupying seats without prior seats, which will not be discussed in the next strategies.

In this case, aircraft configuration with 20 rows, only economy class and two boarding access doors located at the front and rear of the aircraft is used, as shown in Figure 3.2. If two doors can be used, I assume that all passengers seated in rows 1-10 of the aircraft will enter the aircraft through the front door, and the remaining passengers (seated in rows 11-20) will enter the aircraft through the rear door. Several situations with luggage are also being considered. To further analyze the approach proposed, I discuss the seating and walkway obstructions resulting from the methods.

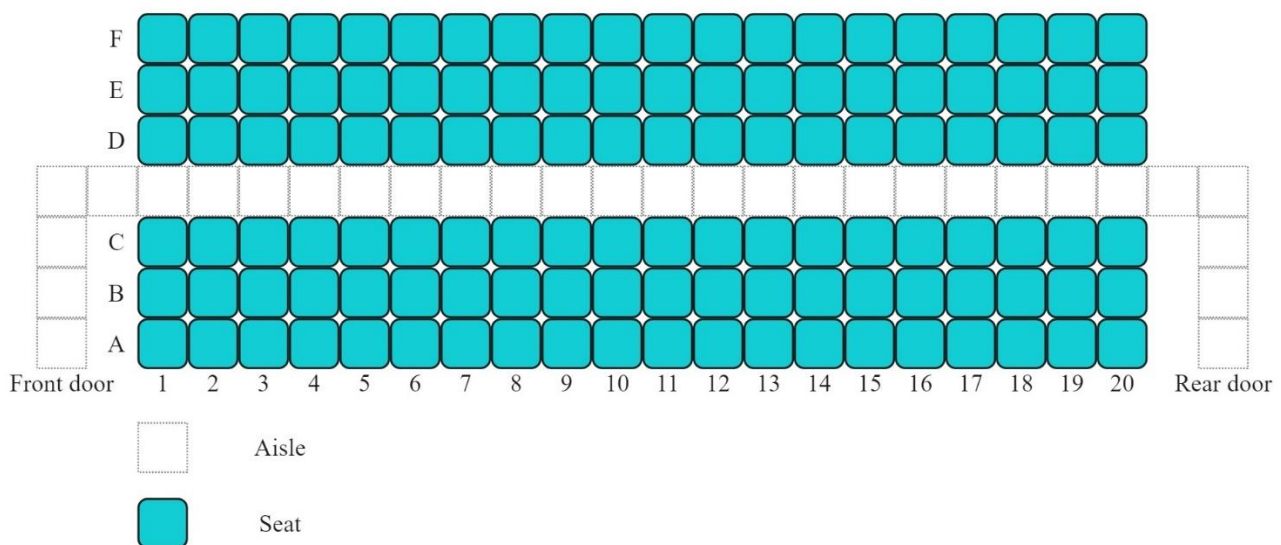

Figure 3.2 – Seat configuration of plane with only economy class.

### 3.1.1. Conflicts during boarding

During boarding, it happens that passengers enter the aircraft together and due to the size of the space limited by the size of the aircraft interior, various conflicts may arise. In particular, there are two types of conflicts during boarding: conflicts at home and conflicts in the aisle. "Conflicts between aisles", when a passenger in the process of boarding and interferes with a passenger in the corridor of the cabin. In Figure 3.3. shows an example in which passenger A, who is trying to pass to seat 5A, is interfered by passenger B, who is assigned to seat 3F and who is putting his hand luggage at this moment. In this case, passenger B is obliged to wait until passenger A finishes putting his luggage to make way for passenger B. "Seat conflicts" occur when a passenger is unable to access their seat because other passenger/passengers, that already seated in the same row are blocking the path to the seat, as shown in Figure 3.4

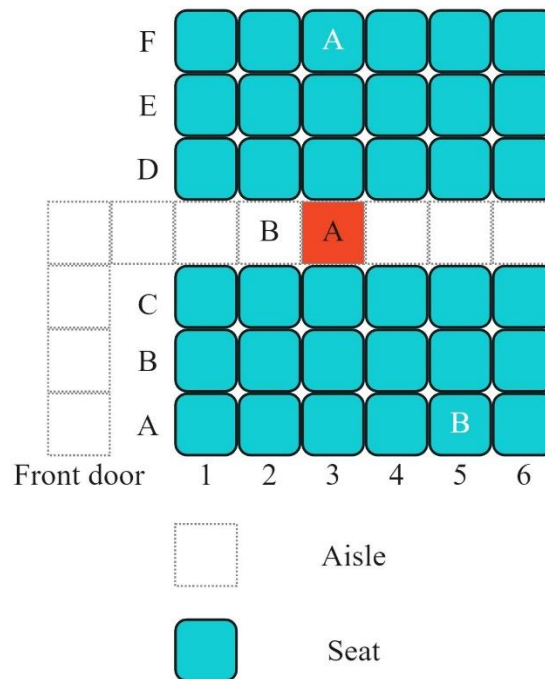

Figure 3.3 – Aisle conflict example.



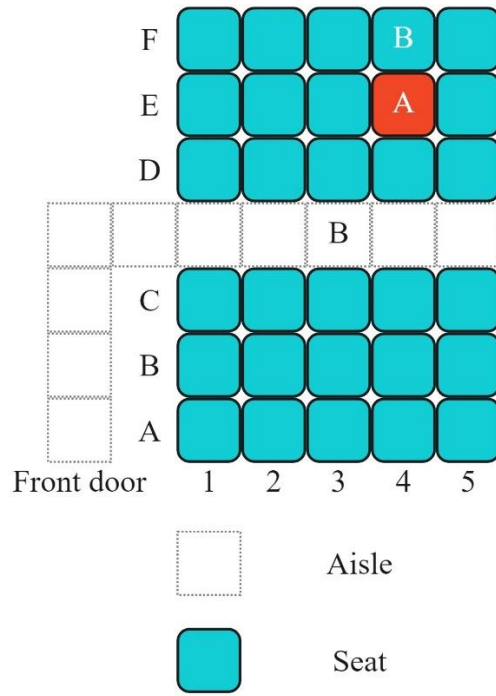

Figure 3.4 – Seat conflict example.

**3.1.2. “Random” boarding strategy**

As the name suggests, the random strategy (see Figure 3.5) is the use of a randomly assigned order to control the boarding process. This means that all passengers can enter the aircraft cabin and take their assigned seats in the order in which they wait in the queue at the boarding gate.

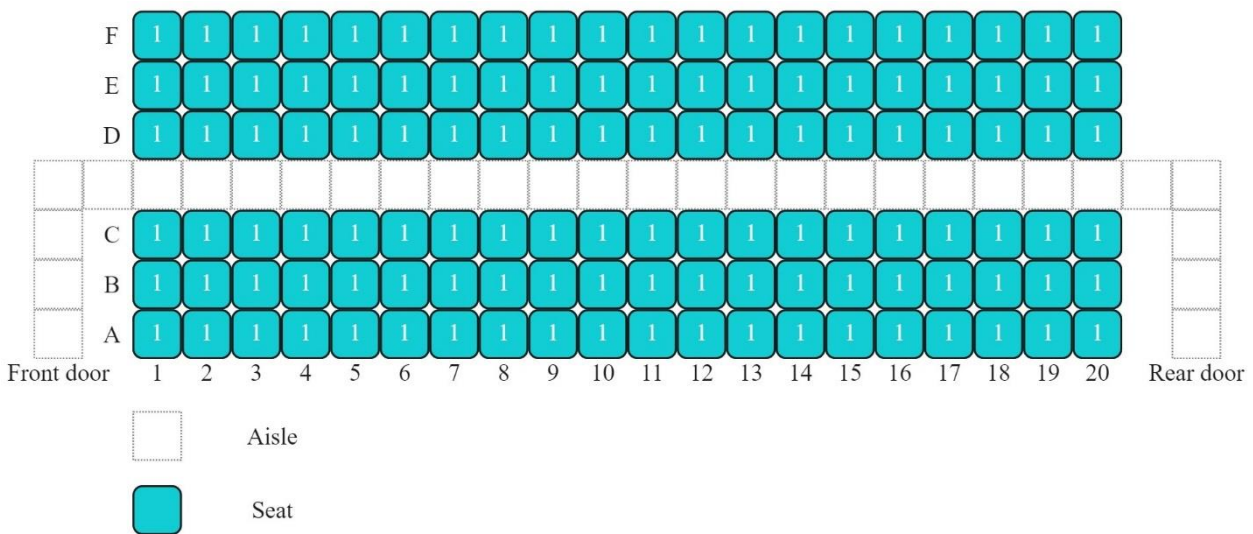

Figure 3.5 – Random boarding.

The random landing strategy is very popular among "low cost" airlines because of its not the worst efficiency and the fact that it is a very suitable strategy for companies that use aircraft with one cabin configuration ("full economy"). This boarding strategy is used by some airlines such as Jet2.com, JetBlue, Ryanair and WOW air.

Note, that the random boarding strategy should not be confused with the "free-for-all" or "free-seating" strategy. The "free-seating" differs from the "free-for-all" in that in the "free-seating" strategy no seats are assigned, but passengers enter the cabin in the order in which they queue at the gate and take the seat they like best. A great example is the Southwest Airlines case, where passengers are divided into three possible groups (A, B or C) according to the time for which they booked the ticket, and they are free to choose the seat they find most comfortable.

### **3.1.3. The “back-to-front” boarding strategy**

In "back-to-front" boarding strategy (see Figure 3.6.), it is expected that passengers will board the aircraft in descending order. This means that the boarding process starts from the back rows and progresses to the front rows. This strategy is able to minimize the number of "Aisle conflicts". This, in turn, leads to a reduction in the overall boarding time. But in order to minimize "Aisle conflicts", passengers must be placed in a special order in the boarding queue depending on which row they will sit in. This fact makes the "back-to-front" strategy rather a theoretical strategy due to the complexity of its implementation.

Due to the fact that it is not easy to separate passengers in the queue for boarding according to the row in which they have been appointed, the "back to front" boarding strategy is commonly simplified by combining rows of seats into blocks. This allows to determine the order in which passengers enter each part of the aircraft, although it cannot guarantee the complete avoidance of "Aisle conflicts", because the process of boarding inside of each block will be at random.

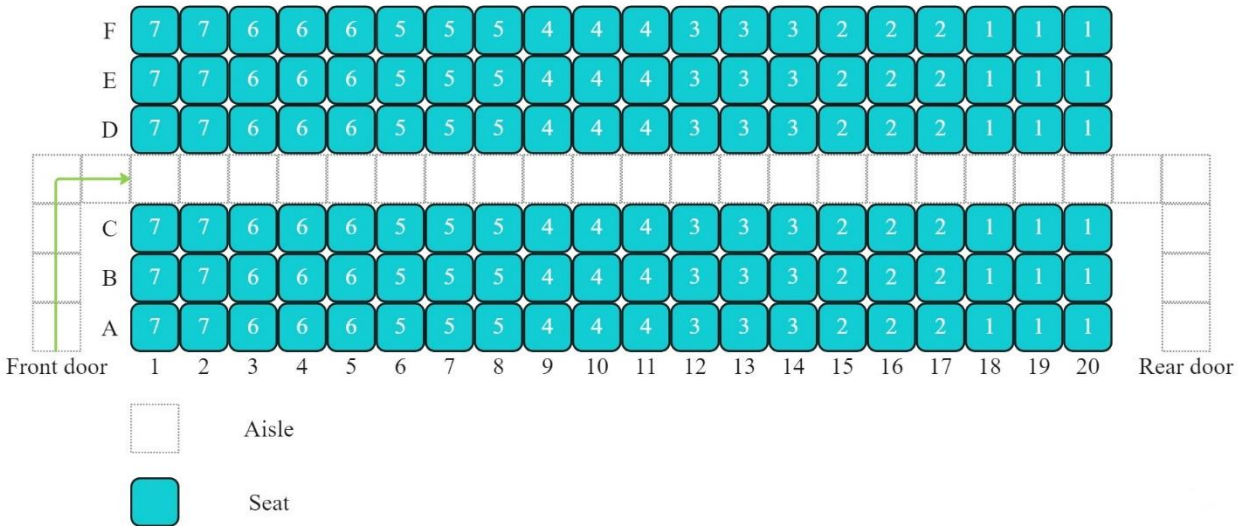

Figure 3.6 – “Back-to-front” boarding strategy by blocks.

**3.1.4. The “front-to-back” boarding strategy.**

The "front-to-back" strategy (see Figure 3.7.) is the reverse order of the previous strategy. In that case, for the same reasons described above, passengers are separated into several boarding blocks depending on the row that corresponds to their assigned seat. Passengers aboard the aircraft in the order established by airline.

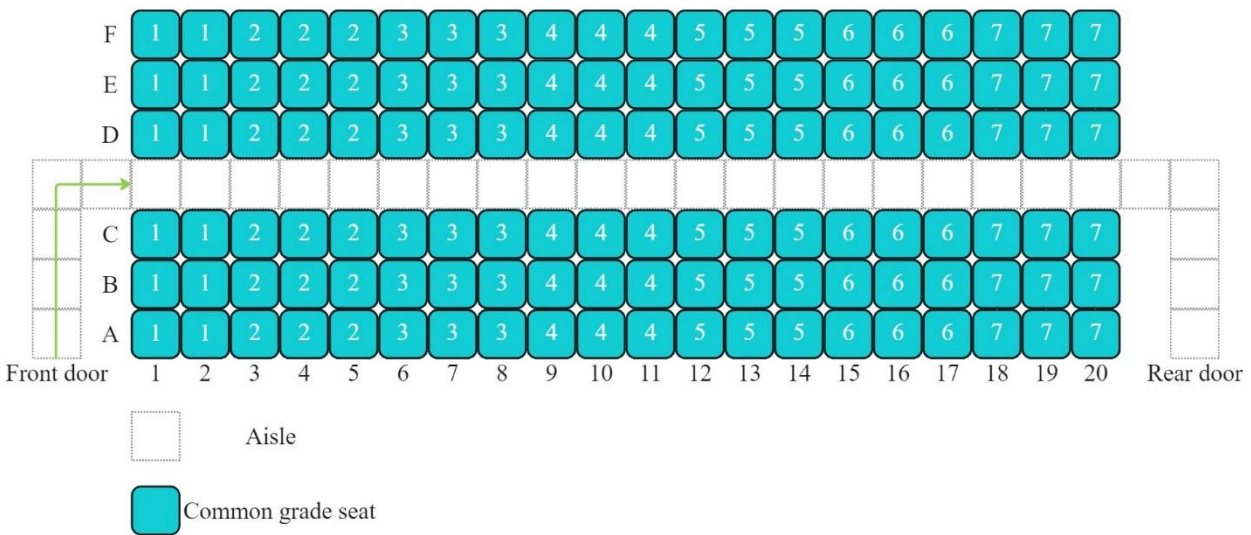

Figure 3.7 – “Front-to-back” boarding strategy.

This strategy is the worst in terms of time efficiency for its implementation.

But this strategy can be used in combination with the “back-to-front” strategy, because it is useful for all those companies that offer various grades on their flights. A nice

example of this is the American Airlines case (see Figure 3.8.), where passengers with "elite" status are the first to board the plane.

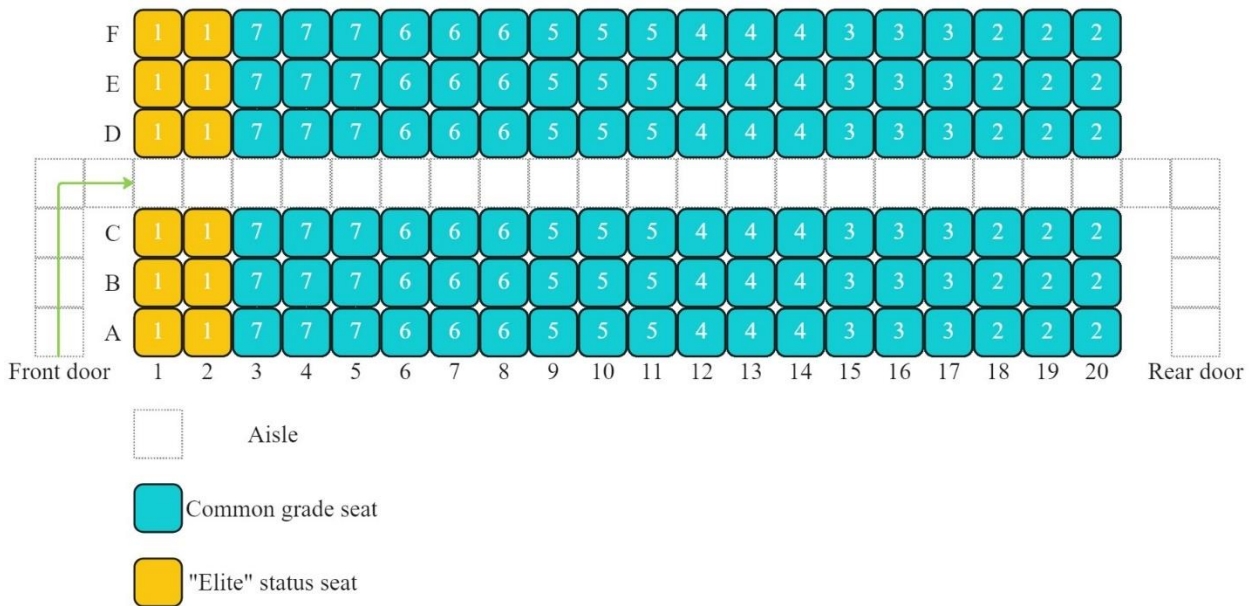

Figure 3.8 – American Airlines boarding strategy with using of “Elite” status seats

### 3.1.5. The “windows-middle-aisle” boarding strategy

The main goal of this boarding strategy is to minimize “Seat conflicts”. But that doesn't stop the "Aisle conflicts" from happening.

To do this, passengers are divided into boarding blocks according to their assigned seats and then enter the aircraft in the following order (see Figure 3.9.): first of all, passengers with the seats located next to the windows - seats A and F; then passengers with the seats that are located in the middle of each of the rows - seats B and E; and, finally, the passengers with the places located along the aisle – seats C and D.

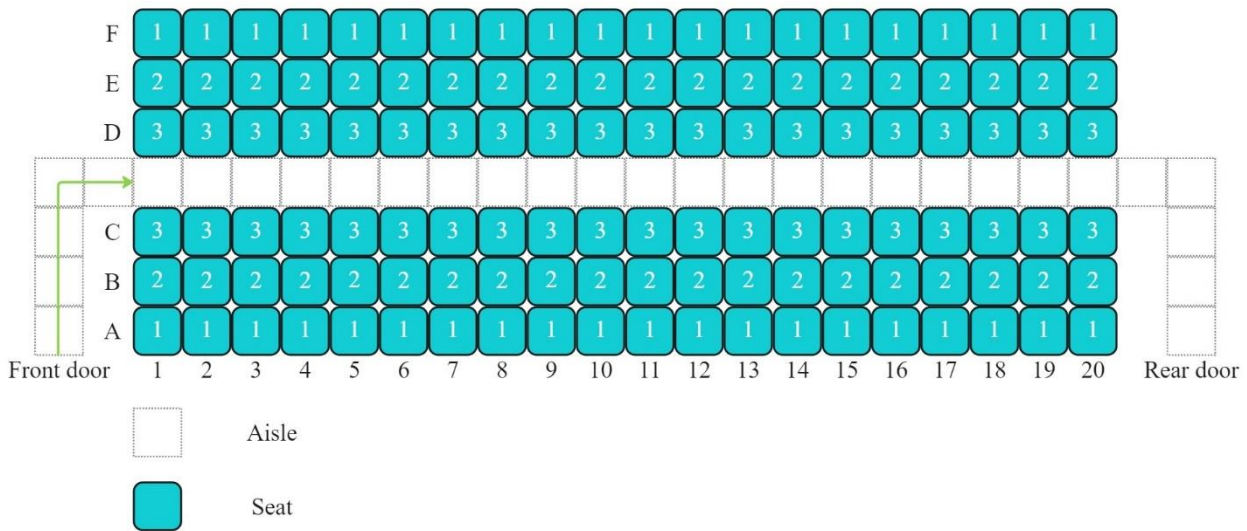

Figure 3.9 – “Windows-middle-aisle” boarding strategy.

### 3.2. Conceptual design of efficient boarding strategy

To analyze and find the most optimal boarding strategy I used simulation data given by Delcea et al. [15]. The main benchmarking method was "back-to-front", and it has already been proven, that this boarding method provides a shorter boarding time compared to the random boarding method used in practical applications with a fully loaded aircraft. A total of 600,000 runs were done with random seat assignment to obtain the average results shown in Table 3.1. The average results for full occupancy level were rounded to the nearest whole number and reported in so-named ticks.

Table 3.1.

#### The average boarding time of different methods compared to random seat strategy

Name of boarding method	Average boarding time (in ticks)	Boarding time compared to random strategy (deviation in %)
Random	277.14	-
Back-to-front	253.00	-7.71
Front-to-back	295.64	+6.675
Windows-middle-aisle	215.5	-21.391

The rightmost column shows the average deviation of specific method compared to “Random” method.



### 3.2.1. “Reverse pyramid” boarding strategy

Van den Briel et al. noted that strategies that divide people into blocks for boarding often lead to underutilization (or incomplete utilization) of the aircraft cabin space, leading to high levels of idle time. To solve this problem, the reverse pyramid strategy was invented. It is a combination of two existing strategies (back-to-front & windows-middle-aisle) with the aim of boarding the aircraft from the outside to the inside with the maximum possible use of the cabin space in the aircraft and minimizing the downtime (see Figure 3.10.).

This is reached by assigning within the same group of passengers with seats in different parts of the aircraft, which maximizes the level of activity in all parts of the plane. Moreover, boarding from the windows to the aisle minimizes potential seat conflicts between passengers, resulting in shorter overall boarding times. Though various studies conclude that the reverse pyramid boarding strategy is extremely efficient and reduces boarding time [17], one of the main disadvantages is its low applicability in real operations. Similar to the window-middle-aisle strategy, the reverse pyramid does not consider of existing relationships among passenger. Boarding from window-seats to aisle-seats means that the passengers, that are travelling together and often occupying neighboring seats, must enter the aircraft at different times.

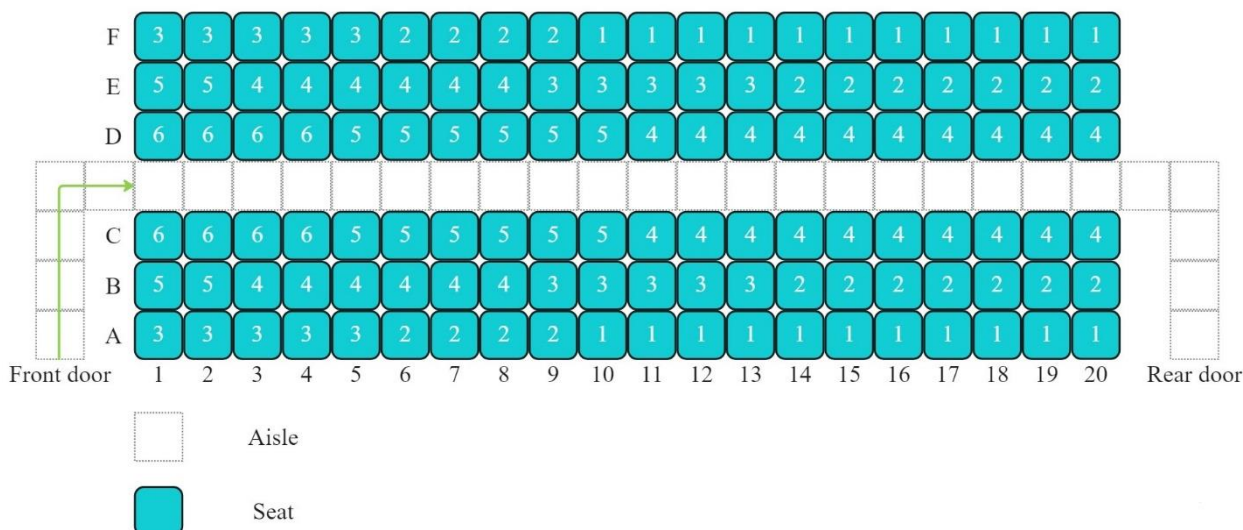

Figure 3.10 – “Reverse pyramid” boarding strategy (only front door access);

Using specific benchmark [15] I can compare average time of this strategy with random method.

Table 3.2.

**The average boarding time of reverse pyramid method compared to random seat strategy**

Name of boarding method	Average boarding time (in ticks)	Boarding time compared to random strategy (deviation in %)
Random	277.14	-
Reverse pyramid (only front door access)	193.43	-30.205

But there's more. This variation of the reverse pyramid combines concepts from the "Windows-middle-aisle" rules and "back-to-front" too, but method applies when both entrances are used. All passengers with seats in rows 1 through 10 enter the front door, and all passengers with seats in rows 11 through 20 enter the back door. See figure 3.11. below.

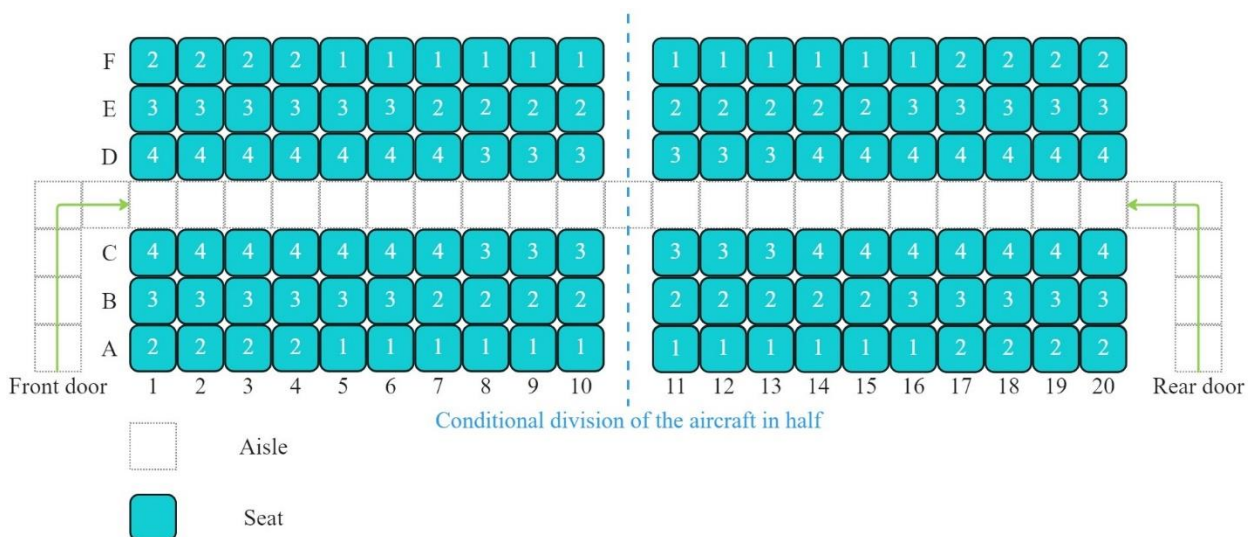

Figure 3.11 – “Reverse pyramid” boarding method when both entrances are used.

Table 3.3.

**The average boarding time of reverse pyramid method (both entrances) compared to random seat strategy**

Name of boarding method	Average boarding time (in ticks)	Boarding time compared to random strategy (deviation in %)
Random	277.14	-
Reverse pyramid (only front door access)	181.75	-34.42

### **Conclusion to part 3**

As a result of the analysis of the presented methods of passenger boarding, as well as simulation data found in open sources [15], I can summarize that individual seating reduces boarding time by 35% compared to random boarding in a given Boeing 737 aircraft.

Using a second door would make boarding faster but eliminate the sequencing via bus transfer or boarding on foot. To provide a close to unobstructed landing for aircraft such as the Boeing 737, a landing gate with an additional entrance to the aircraft, such as an over-wing bridge, is required. Depending on the airline's specific boarding procedures, reducing the amount of carry-on luggage to one piece per passenger can reduce boarding time by 5-15%, and further eliminating carry-on luggage/bags (e.g., allowing only a few over the shoulder bags) can reduce boarding time by 20%-25% compared to a calibrated Boeing 737 scenario with a random landing strategy [16]. A very promising stochastic approach to further improving aircraft boarding is the "reverse pyramid" strategy.



## **PART 4. ENVIRONMENTAL PROTECTION.**

### **INFLUENCE OF AIRPLANE ON THE ENVIRONMENT AT THE AIRPORT'S ZONE**

#### **4.1. Introduction**

The fact that airplanes pollute the environment with their exhaust emissions is quite obvious and unquestionable. In fact, any human economic activity harms nature and contributes to climate change. The only question is how much this or that type of activity contributes to this overall process. Civil aircraft and the systems of ground infrastructure serving them have sound, vibration, electromagnetic, ionizing and some other negative environmental impacts.

Pollutants emitted by aircraft engines also contribute to the pollution of the earth's surface. An additional contribution to pollution comes from the current repair and maintenance of civil aircraft, accompanied by the formation of process wastewater at airports, maintenance facilities, auxiliary production facilities, aircraft washing stations, buildings and auxiliary facilities. Surface wastewater contains oil products, detergents, disinfectants, de-icing and anti-icing substances, products of destruction of materials of aircraft landing gear and ground support equipment. Start-up of engines, taxiing, take-off and landing of airplanes, i.e., those operations that release into the environment a significant number of products of incomplete combustion of fuel, deposited on the ground and accumulating in it within 10 ... 15 years depending on the period of their natural degradation, take place on the airport territory. The concentration of carcinogenic hydrocarbons in the soil of aerodromes is close to critical, and near runways and airstrips is higher than the maximum permissible norms. The concentration of carcinogens in the grass growing near the runway and airstrips is 10 times higher. In a worm feeding on contaminated grass, the concentration of carcinogens is 100 times higher than in soil. It is very difficult to trace the food chain and even more so to say with certainty that at the end of the food chain was an animal consumed by humans. It is unequivocally proven only that grass (hay) must be disposed of and not fed to animals [18].

Aviation accounts for approximately 3 percent of the total anthropogenic greenhouse effect. It must be said that not all experts agree with this estimate. Which is quite natural, because this figure is very approximate, partly even speculative. After all, the exhaust gases from aircraft contain carbon dioxide, water vapor, nitrogen oxides and fine soot. All of these components have an ambiguous and sometimes multidirectional impact on the environment and the planet's climate.

The carbon dioxide is evenly distributed. The fact is that jet fuel, kerosene, is a complex mixture of hydrocarbons. It contains 86 percent carbon and 14 percent hydrogen. During combustion carbon combines with air oxygen, so burning every kilogram of kerosene adds 3.15 kilograms of carbon dioxide to the atmosphere. Since carbon dioxide is very stable, it is evenly distributed around the globe.

Under ideal conditions, the final combustion products of jet fuels should be carbon dioxide and water vapor, the ratio between which depends on the carbon and hydrogen (C/H) content of the fuel. If jet fuel consisted only of hydrocarbons, the chemical composition of which can be schematically expressed by the formula  $C_nH_m$ , then its thermal oxidation equation could be written as:

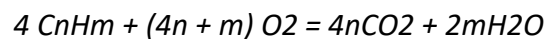

In fact, the general appearance of an aviation fuel molecule can be represented as  $C_nH_mO_xN_yS_z$ , and there are other combustion products present in the composition of emissions resulting from its combustion in civil aircraft engines, which constitute no more than 9% of the mass of substances emitted by an aircraft engine. A small part of them (about 0.4%) is due to the design features of the aircraft engine, which allow incomplete fuel oxidation, accompanied by the formation of carbon monoxide (CO), sulfur oxides (SO<sub>x</sub>), non-methane volatile organic compounds (NMVOC or  $C_nH_m$ ), nitrogen oxides (NO<sub>x</sub>).

In addition, in real conditions, it is practically impossible to ensure the stoichiometric ratio 3 between aviation fuel and oxidizer (atmospheric air oxygen) required for complete combustion in all modes of operation of aircraft engines. It should be added that the ratio of the components of the exhaust mixture may vary depending on the type and modification,

operating conditions and service life of the aircraft engine, as well as the nature and composition of the fuel. In addition, CO<sub>2</sub> easily migrates in the vertical direction as well, so whether it was formed near the surface of the Earth or at an altitude of 10-11 thousand meters, where most civil aviation corridors are located, does not play any role.

Therefore, it is not difficult to calculate that about 2.2 percent of all anthropogenic carbon dioxide is emitted into the atmosphere by airplanes. Road transport accounts for about 14 percent, and other modes of transport - sea, rail, and others - produce a total of 3.8 percent. The intensity of pollutant and greenhouse gas emissions depends on the operating phase of the aircraft engines, which are determined by the flight segment. The work performed by aircraft engines from the time they start on the ground, during taxiing, taking off and climbing within 900 meters, and descending from 900 meters, landing, and taxiing through the airport area again were combined into the takeoff and landing cycle (TLC) phase. Thus, the geographically localized aviation emissions of pollutants and greenhouse gases from civil aircraft into the planetary boundary air layer near the airport and on its territory up to the altitude of 900 m correspond to the phase of the TLC.

In the airport area, aviation emissions account for about 60% of the gross air emissions. Their intensity depends on the environmental perfection of aircraft engines, the intensity of air traffic, the system of aircraft dispatching in the airspace near the airport and on the ground on its territory and, finally, on the number of passengers and cargo transported. It should be noted that the intensity of aviation emissions at different segments of the TLC is not equal. So, at takeoff and climb up to 900 m the aircraft engines use, as a rule, 100% and 85% of the maximum available power (thrust) and fuel consumption for takeoff. Accordingly, the specific emissions and fuel consumption of the aircraft at this phase of the TLC are the highest.

When taxiing, a small, and not constant, fraction of the takeoff thrust is used, which is about 7%. During descent, the aircraft's engines use about 30% of maximum thrust. However, despite the differences in the intensity and absolute value of emissions at different segments of the TLC, it is customary to calculate for the entire takeoff and landing cycle. The estimation of the total quantity of the main pollutants entering the air environment of the controlled area of the civil aviation airport serving a city with a population of millions

of people as a result of its industrial activity (without taking into consideration the air pollution by special-purpose motor transport and other ground sources) shows that on the area of about 4 km<sup>2</sup> about 1000-1500 kg of carbon oxide, 300...500 kg of hydrocarbon compounds and up to 500 kg of nitrogen oxides are emitted into the atmosphere per day. Such amount of emitted harmful substances under an unfavorable combination of meteorological conditions (presence of fogging and temperature inversion) can lead to an increase in their concentrations to values close to the MPC (Maximum permissible concentration).

## **4.2 Water vapor**

It is much more difficult to assess the role of water vapor emitted by aviation. That is, quantitative assessment is not difficult: it is known that burning one kilogram of kerosene produces 1.23 kilograms of water vapor. The qualitative assessment, however, is more difficult. When hot and humid exhaust gas enters the cold environment, the steam condenses, forming tiny water droplets. Water vapor both heats and cools.

This development is observed in 10-20 percent of cases. In other words, air transport actually increases cloud cover on our planet. However, the question is relevant here: is it good or bad for the climate? On the one hand, clouds reflect some of the short-wave solar radiation back into space. On the other hand, ice crystals in such clouds absorb long-wave infrared radiation, and then direct some of this heat to the earth. There are two differently directed effects, and experts cannot say for sure which one prevails, although most experts tend to believe that heating is still somewhat stronger than cooling.

## **4.3 Effects of carbon black**

Another factor affecting the environment and the planet's climate is soot in the form of fine dust. The diameter of soot particles in aircraft exhaust gases ranges from 5 to 100 nanometers. It is clear that this dust, as soon as it enters the atmosphere, contributes to the formation of a condensation trace, as some of the water vapor emitted by the aircraft simultaneously with the soot settles on it. In addition, soot particles can remain suspended in the air for weeks, contributing to cloud formation. However, these processes also involve

dust particles of other origin, both natural (volcanic dust, desert dust, dust from soil erosion) and anthropogenic (industrial emissions), as well as liquid droplets of different nature.

In such a situation, it is extremely difficult to assess the effect of soot in general, and even more soot emitted specifically by aircraft. Even the question of whether soot contributes to an increase or decrease in cloud cover has not yet been answered definitively and unambiguously.

#### **4.4. Ozone**

A separate topic is the effect of aircraft exhaust gases on the concentration of ozone in the atmosphere. It is known that the combustion chamber of a modern aircraft engine can heat up to 2,000 degrees Celsius. At such temperatures, free nitrogen in the air binds to oxygen, forming NO and NO<sub>2</sub> oxides, but these oxides have a multidirectional effect on atmospheric ozone: at high altitudes they decompose it, at low altitudes they form it.

Ozone decomposition prevails at altitudes above 16,000 meters, but ordinary civilian aircraft do not fly there. Their corridors are below 12 thousand meters, and their nitrogen oxides cause active ozone formation. Unfortunately, this so-called tropospheric ozone enhances the greenhouse effect - just like carbon dioxide or water vapor. In addition, increased ozone in the air has a negative effect on health. And this ozone has nothing to do with the stratospheric ozone layer, which protects our planet from harsh ultraviolet radiation. In other words, the ozone hole over Antarctica cannot be patched with airplane exhaust.

#### **4.5. Sound, vibration and other effects of civil aviation and technical means of supporting infrastructure**

Sound, vibration and other impacts of civil aviation and airport support infrastructure have been studied since the 1970s. By the level of noise load aviation takes the leading place among all other sectors of the economy. The main categories of persons exposed to the adverse effects of aviation noise include: the population living near the airport and flight paths, employees and visitors to airports and other aviation infrastructure facilities, and passengers. Those who live in the zone of influence of airports receive a daily dose of noise that is 3 times higher than the permissible value.

The sources of noise generated by modern subsonic airplanes are aircraft engines, auxiliary power units and airflow streamlined airframe (elements of wing mechanization). During ground operation of aircraft engines ("low gas" mode), the main sources of noise are auxiliary power units. When taking off, climbing and flying at cruising altitudes, the noise of the main engines prevails, and the highest noise level is produced by the aircraft at cruising altitudes. On landing approach, the noise associated with the airflow of the airframe makes the main contribution. For non-powered twin-turboprop engines, the internal noise of the hot part is composed of the noise of the combustion chamber, turbine and exhaust duct. The jet noise is caused by turbulent pulsations in the zone of its mixing with atmospheric air.

As the jet diameter and gas temperature increase, the noise spectrum shifts toward low frequencies, and as the flow velocity increases, it shifts toward high frequencies. Therefore, modern engines are characterized by noise in the low-frequency and middle parts of the overall spectrum. The noise spectrum of jet engine occupies a wide frequency band from 10 to 20 thousand Hz, but its main energy is concentrated in the area of 50-10 thousand Hz. The noise spectrum of jet engine blades is concentrated in the area of 2000-5000 Hz, and the air jet noise spectrum is concentrated in the area of 100-400 Hz. The main sources of noise at the aerodrome are aircraft engines during start-up and warm-up, as well as during take-off and landing of aircraft.

The average duration of ground operation of the engines of one aircraft, including the average taxiing time on the runway before takeoff and after landing from the start of the engines to their shutdown, is from 10 to 18 minutes for aircraft of different types. Under these conditions the noise level in the residential areas (on the side facing the airfield at the distance of 2 km) is equivalent to 75-85 dBA, and the maximum noise level is 90-92 dBA [19]. In order to limit the sound load created by aircraft, it is normalized on the ground (technical standardization) and in the territory of residential areas (hygienic standardization).

The technical regulations reflect the capabilities of modern aircraft and engine construction to achieve minimal noise levels under standard flight conditions or during take-off and landing. In order to protect public health and the environment in the design of

residential development near airports, permissible values of aviation noise levels are established by regulatory documents. Thus, the civil airport is a complex source of intensive non-permanent noise generated by aircraft. It should be noted that large airports, as a rule, are located in densely populated areas. Accordingly, a significant number of residents will suffer from the increased noise load produced by aircraft taking off and landing, as well as moving on the ground. In order to reduce the noise load from civil aircraft the following measures are envisaged:

- limiting the operation of the noisiest types of aircraft and replacing them with less noisy ones, both domestic and foreign, that meet the regulatory requirements of ICAO Annex 16 [20];
- limitation or prohibition of night operation of the noisiest types of aircraft; scheduling of aircraft movement, taking into account the hourly and daily noise balance of the territory near the airport by exit routes;
- organization of rational ground and flight operation of aircraft;
- improvement of air traffic control techniques, avoiding taxiing aircraft on the airfield with engines running due to the use of their towing to the launch site by special tractors (the method is widely used in many major airports).

From the presented analysis of measures to limit the negative impact of acoustic load, it follows that the problem associated with high sound pressure in the area of airports, adjacent residential areas, as well as other natural and territorial complexes is well known and sufficiently studied. A set of measures has been developed, the implementation of which has made it possible to slightly reduce the sound pressure in the area of airports and the surrounding area, despite the increase in the intensity of operation of the civil aircraft fleet.

Nevertheless, the task of limiting the sound impact at airports and the surrounding area cannot yet be considered completely solved. Negative effects caused by vibration are similar in nature to acoustic ones and are characterized by similar quantitative indicators. Sources of vibration are aircraft landing, and it spreads mainly on the ground, reaching the foundations of buildings, structures and engineering structures, which are destroyed by the induced vibrations. Vibration affects not only the employees of the industry, but also the passengers of aircraft.

However, the perceptible effect of vibration is quite limited, since it extends to a distance of 150...200 m from the runway. As in the case of effects caused by sound effects, the negative effects of vibration load are well enough studied. Special measures for its limitation in the airport area have been developed and are being taken. However, this problem also cannot be considered as completely solved. At the same time, it should be noted that neither acoustic nor vibration loading can have a large-scale impact on the environment and the climate. In the field of reduction of noise and emissions generated by international civil aviation, significant progress has been made.

For example, significant technological advances have resulted in a 75 percent reduction in the noise generated by current aircraft, and an 80 percent increase in fuel efficiency per passenger-kilometer compared to aircraft from the 1960s. The development of new innovative technologies that can have an impact on the environment and new energy sources for aviation is proceeding at a rapid pace, so ICAO will need to make significant efforts to keep up this pace, updating and developing relevant environmental SARPS and ICAO guidance materials as necessary.

Less common, but quite significant negative impact factors are electromagnetic and ionizing radiation. Sources of electromagnetic radiation are radio equipment - radar stations, radio navigation systems and means of radio communication, the main purpose of which is to ensure the movement and navigation of aircraft. The complex of ground radars includes airfield and en-route observation radars, en-route radar complexes, airfield survey radars, landing and meteorological radars. They emit electromagnetic energy in the most dangerous frequency range for humans (300 MHz ... 300 GHz) [21]. Development of this type of technology is mainly on the way of continuous increase in the intensity of radiated power, which is hundreds and thousands of times higher than the maximum permissible levels established for the human.

An equally dangerous type of physical impact is ionizing radiation, whose sources are found in fuel level control systems, instruments with glowing dials and aircraft icing sensors. Ionizing radiation is used in baggage screening machines in airports, and ubiquitous electronic computer complexes. These instruments require a system of special measures and precautions not only for handling, but also for disposal at the end of their service life and



write-off. Handling rules and precautions for electromagnetic and ionizing radiation sources have been developed for all civil aviation facilities where they operate.

It should be noted that the negative effects associated with the use of this equipment are local in nature and, therefore, their large-scale impact on the environment and the climate is of little significance.

Civil aircraft and the ground infrastructure serving them also have sound, vibration, electromagnetic, ionizing and other impacts. The impact of noise and vibration loads, electromagnetic and ionizing radiation on natural and economic systems in the area of airports and the surrounding area is well studied. It is localized in the near zone of airports, beyond which the negative effects caused by these impact factors are relatively small.

#### **Conclusion to part 4**

Air transport is one of the most important branches of social production and is designed to meet the needs of the population and social production in transportation. At the same time, transport is one of the main pollutants of the environment.

Until recently, the issue of the impact of aviation on the environment and human health occupied an insignificant place in the general discussions on environmental protection. But the public awareness of the importance of environmental problems and concern about ways to solve them caused the governments of many countries to adopt appropriate policy measures aimed at reducing the impact of aviation on nature. Therefore, recently environmental issues in air transport processes have attracted much more attention than it was before. There is a frank desire to preserve and improve the current level of environmental quality.

Many countries in Europe and North America have economic mechanisms to compensate for the harmful impact of civil aviation on the environment. Unfortunately, little attention is paid to these issues in Ukraine.

Theoretical and methodological approaches to ecological and economic assessment of the impact of civil aviation on the environment are almost completely absent. Theoretical and methodological provisions related to the creation of a mechanism for compensation for environmental and economic losses from air transport processes require further deepening

and supplementation. At the same time, according to objective estimates, in the near future the expected growth of air traffic volumes may reach 30-40% per year, and with the introduction of a new air navigation service system in Ukraine, which corresponds to the new air traffic control strategy, the number of transit aircraft is expected to increase by 5-6 times!

The increase in the volume of air transport in our country will certainly lead to a corresponding increase in environmental impact. Thus, if even now the quantitative indicators of ecological and economic losses are insignificant, in the near future their significant growth is possible.

## **PART 5. LABOUR PROTECTION**

### **OCCUPATIONAL HEALTH AND SAFETY MEASURES FOR SUPPLY CHAIN ENGINEER**

#### **5.1. Introduction**

The process engineer selects the equipment on which the technological process should be carried out, the optimal modes of operation, the basic methods of quality control, and maintains technological documentation. Technologist is at the head of inventive and rationalization work. He participates in experimental work on the development of new technological processes and their implementation in production, in organizational and technical measures for the timely development of production capacity. Undoubtedly, such work is the work of increased danger and observance of norms and requirements of labor protection is a priority both for the employee and for the employer.

#### **5.2. Harmful and dangerous production factors**

The engineer-technologist may be exposed to a number of dangerous and harmful factors of production, the most significant of which are the following:

- increased voltage level in the PC power supply and control circuits, which can lead to electrical injury to the operator in the absence of earthing or grounding of the equipment (the source - alternating current of industrial frequency 50 Hz voltage 220 V, serving to power the PC, as well as high frequency currents of up to 12 000 V power supply systems of individual circuits and display units);
- an increased level of electric and magnetic field strength in a wide frequency range (including from 50 Hz industrial frequency currents from PCs, auxiliary devices, other electrical installations, power cables, lighting installations, etc. - especially when there is no grounding or neutral grounding of the equipment);
- do not meet the sanitary standards visual parameters of displays, especially having a grain size (pixel) of 0.3 mm or more, frame frequency - 50-75 Hz, as well as violations of the visual parameters of certified PC (the appearance of unstable images) due to the impact on the display of high values of the magnetic field from the current sources of

industrial frequency 50 Hz (the so-called indirect effect of magnetic fields); increased direct and reflected brilliance level; increased brightness of the light image;

- excessive energy streams of blue-violet light from the display screen in the visible range of electromagnetic wavelengths, reducing the clarity of image perception by the eye;

- low or high level of illumination;

- increased level of static electricity;

- increased level of air gasses (first of all - carbon dioxide and ammonia, which are formed during exhalation), especially in poorly ventilated rooms;

- increased level of dustiness of the working area air from external sources;

- microclimate parameters that do not meet the standards: increased temperature due to constant heating of PC parts, decreased humidity, decreased or increased air speed (mobility) of the working area;

- violation of standards for the aeroionic composition of the air, especially in rooms with a developed system of supply and exhaust ventilation and (or) with air conditioners, where the concentration of negatively charged light oxygen ions (aeroions) useful for the body may be 10-50 times lower than normal, while the concentration of harmful positive ions is much higher than normal;

- increased content of pathogenic (disease-causing) microflora (primarily staphylococcus aureus) in the air, especially in winter when there is high indoor temperature, poor airing, low humidity and violation of the aeroionic composition of the air;

- increased noise level from running PC and printer cooling fans, unregulated fluorescent lighting sources, etc.;

- increased level of soft X-ray radiation from the electron-beam tube of the display (this factor takes place only in older VDTs (visual display terminal) produced before 1992);

- increased eye strain and adynamic eye muscles, i.e., their low mobility with high static visual tension for a long time, which can cause various eye diseases, especially

such as spasm of accommodation (loss of muscle contraction), decreased visual acuity, decreased reserve of relative accommodation, and then myopia;

- monotony of labor;
- increased mental stress due to the large volume of information processed and assimilated;
- physical overstrain due to the irrational organization of the workplace (uncomfortable chairs, tables, lack of supports for the text, for the feet and hands, etc.), which greatly increases the strain on the muscles of the spine, legs, arms, neck and eyes;
- increased nervous and emotional stress (an additional harmful manifestation of work on the PC - this accelerates the withdrawal from the body of many essential vitamins and macronutrients);
- external constantly acting environmental factors: the presence of harmful substances (carbon monoxide, ozone, ammonia, nitrogen oxides, sulfur, etc.), salts of heavy metals and organic compounds (phenol, benz(a)pyrene, formaldehyde, polychlorinated biphenyls, free radicals, etc.) in the air of the working area;
- sharp deterioration of air quality in terms of aeroionic composition, an increase in its content of various allergens, fungi, viruses, bacteria, microorganisms;
- increased information loads from the outside (and not just while working on the PC) causes additional mental overload, stress, which also increases the likelihood of diseases of the vision and other most stressed and weakened organs;
- in addition to eye disease, there may be diseases of the heart, kidneys, nervous system, gastrointestinal tract, immune and bronchopulmonary systems.

If the above factors affect a person whose body is not completely healthy, such a complex negative impact is greatly exacerbated (according to statistics, people suffering from various gastrointestinal diseases, especially gastritis, dysbacteriosis of various degrees, etc., or lack of many vital vitamins, micro- and macro-elements, proteins, amino acids, almost 90%. Thus, in the process of work an engineer-technologist is affected by the following hazardous and harmful occupational factors:

1. physical:

- 1.1. increased levels of electromagnetic radiation;
  - 1.2. increased levels of ultraviolet radiation [25];
  - 1.3. increased level of infrared radiation [25];
  - 1.4. increased level of static electricity;
  - 1.5. increased levels of dustiness in the air in the work area [22];
  - 1.6. increased content of positive air ions in the air of the working area [22];
  - 1.7. reduced content of negative air ions in the air of the working area [22];
  - 1.8. low or high humidity in the working area [22];
  - 1.9. reduced or increased mobility of the working area air [22];
  - 1.10. high noise level; [23]
  - 1.11. increased or decreased level of illumination [24];
  - 1.12. increased level of direct brilliance [24];
  - 1.13. increased level of reflected brilliance [24];
  - 1.14. increased level of blinding;
  - 1.15. uneven brightness distribution in the field of view;
  - 1.16. increased brightness of the luminous image;
  - 1.17. increased level of pulsation of the luminous flux;
  - 1.18. increased voltage value in an electrical circuit, the short circuit of which can occur through the human body.
2. chemical:
    - 2.1. increased content of carbon dioxide, ozone, ammonia, phenol, formaldehyde and polychlorinated biphenyls in the working area air.
3. psycho-physiological:
    - 3.1. visual strain;
    - 3.2. attention span;
    - 3.3. intellectual stress;
    - 3.4. emotional stress;
    - 3.5. long static loads;
    - 3.6. the monotony of work;
    - 3.7. large volume of information processed per unit of time;

3.8. irrational organization of the workplace.

4. biological:

4.1. increased content of microorganisms in the air of the working area.

### **5.3. Analysis of working conditions and development of protective measures**

The manufacturing engineer, while on the job, is obliged to:

- perform only the work assigned to him and for which he has been instructed;
- keep the workplace clean and tidy throughout the day;
- keep all ventilation openings of the devices open;
- only use the external mouse device with the special mouse pad;
- if it is necessary to stop working for a while, close all active tasks correctly;
- only turn off the power supply if the operator has to be in the immediate vicinity

of the VDT during a computer break (less than 2 m), otherwise the power supply may not be turned off;

- comply with sanitary regulations and observe work and rest schedules;
- comply with the rules for operating computer equipment in accordance with

the operating instructions;

- choose the most physiological mode of displaying black symbols on a white background when working with text information;

– comply with the regulated breaks established by the regime of working time and perform the recommended exercises for the eyes, neck, arms, torso, legs during physical recesses and physical recesses;

- keep the distance from your eyes to the screen within 60 cm.

It is forbidden to start work if:

– there is no a hygienic certificate on the VDT, which includes an assessment of visual parameters;

– there is no information about the results of certification of working conditions at this workplace or if there is information that the parameters of this equipment do not meet the requirements of sanitary norms;

- there is no protective screen of "full protection" class;
- The protective screen screen's grounding conductor has been disconnected;
- Equipment malfunction has been detected;
- absence of protective earthing of the PC or VDT devices;
- absence of carbon dioxide or powder fire extinguisher and first aid kit;
- violation of hygienic norms of VDT placement (in case of single-row

arrangement less than from the walls, in case of arrangement of workstations in columns at a distance less than 3 m, in case of arrangement on the area less than 6 sq.m. per workstation, in case of row arrangement of displays with screens facing each other). During work it is forbidden: to touch simultaneously the monitor screen and keyboard; to touch the back of the system unit (processor) when the power is on; switching interface cables connectors of peripheral devices when the power is on; cluttering the top panels of devices with papers and foreign objects; allow cluttering the workplace with paper to prevent the accumulation of organic dust; make power off while performing active tasks; make frequent power switching.

#### **5.4. Fire safety rules at the workplace**

Ensuring fire safety is an integral part of production or other activities of officials, employees of enterprises and entrepreneurs. This should be reflected in employment agreements (contracts) and charters of enterprises [26].

The head of the enterprise must determine the duties of officials (including deputy heads) concerning fire safety, appoint persons responsible for fire safety of separate buildings, constructions, premises, sections, etc., technological and engineering equipment, as well as than retention and operation of technical means of fire protection.

Duties concerning fire safety, retention and operation of fire protection equipment must be reflected in the relevant job descriptions (functional responsibilities, instructions, regulations, etc.).

At each enterprise, taking into account its fire hazard, an order (instruction) must establish an appropriate fire protection regime, including certain:



- the possibility of smoking (smoking area), the use of open flame, household heating appliances;
- in all cases of detecting the breakage of power wires, failure of grounding and other damage to electrical equipment, the smell of burning immediately turn off the power and report the emergency situation to the manager and the electrician on duty;
- If you find a person caught under voltage, immediately release him from the action of current by turning off the power supply and before the arrival of the doctor to provide first aid to the victim; in case of fire of equipment, turn off the power and take measures to extinguish the fire with a carbon dioxide or powder fire extinguisher, call the fire department and report the incident to the head of the work.

### **Conclusion to part 5**

The occupational safety policy is based on the principles of:

- priority of life and health of employees, full responsibility of the employer for the creation of appropriate safe and healthy working conditions;
- increasing the level of industrial safety by ensuring comprehensive technical control over the condition of production facilities, technologies and products, as well as creating safe and non-hazardous working conditions.

## GENERAL CONCLUSION

Boarding an aircraft is at the critical turnaround path. An efficient boarding procedure should take into account as operational constraints, as well as individual passenger behavior. Contrary to the refueling, catering and cleaning processes, the boarding process is mostly controlled by the passenger and not by airports or airlines staff. The models for the estimation of boarding procedures mainly depend on the assumptions related to the individual passenger processes in the aircraft rather than on reliable field data measurements.

This thesis provides an analysis of the operations data including classification of boarding times, passenger arrival times, passenger interaction times as a fundamental basis for estimation of boarding simulation models. After the preliminary design of the mid-range passenger aircraft and concept about the layout of passenger cabin, these data are used to compare the results after and find the optimal boarding procedure for further use.

This thesis uses the analysis of simulations of passenger behavior in different boarding scenarios, where the passenger movement is defined as a one-dimensional, a stochastic and a time/space discrete transition process. These data are used to compare the results after and find the optimal boarding procedure for further use.

The influence of airplane on the environment at the airport's zone have been discussed in the part of environmental protection.

The occupational health and safety measures for supply chain engineer are also presented in the part of labor protection.

## REFERENCES

1. Marelli, S., Mattocks, G., & Merry, R. (1998). The role of computer simulation in reducing airplane turn time. *Boeing Aero Magazine*.
2. Kierzkowski, A., & Kisiel, T. (2017). The human factor in the passenger boarding process at the airport. *Procedia Engineering*, 187, 348-355.
3. Schultz, M., Kunze, T., & Fricke, H. (2013). Boarding on the critical path of the turnaround. Tenth USA/Europe Air Traffic Management Research and Development Seminar (ATM '13). Chicago.
4. Steiner, A., & Philipp, M. (2009). Speeding up the airplane boarding process by using pre-boarding areas. 9-th Swiss Transport Research Conference. Monte Verica/Ascona.
5. Bronsvort, J.; McDonald, G.; Porteous, R.; Gutt, E. Study of aircraft derived temporal prediction accuracy using FANS. In *Proceedings of the 13th ATRS World Conference*, Abu Dhabi, UAE, 27–30 June 2009.
6. Mueller, E.R.; Chatterji, G.B. Analysis of aircraft arrival and departure delay. In *Proceedings of the AIAA Aviation Technology, Integration, and Operations Conference*, Los Angeles, CA, USA, 1–3 October 2002.
7. Eurocontrol. Performance Review Report—An Assessment of Air Traffic Management in Europe during the Calendar Year 2014, 2015, 2016, 2017 Performance Review Commission; Eurocontrol: Brussels, Belgium, 2017.
8. Tielrooij, M.; Borst, C.; van Paassen, M.M.; Mulder, M. Predicting arrival time uncertainty from actual flight information. In *Proceedings of the 11th USA/Europe ATM Seminar*, Lisbon, Portugal, 23–26 June 2016.
9. IATA. AHM 730—Codes to be used in aircraft movement and diversion messages. In *Airport Handling Manual*, 37th ed.; IATA: Montreal, QC, Canada, 2017.
10. Eurocontrol. CODA DIGEST All-Causes Delay and Cancellations to Air Transport in Europe—2016; Eurocontrol: Brussels, Belgium, 2016.
11. SESAR. Single European Sky ATM Research Programme. In *European ATM Master Plan*, 2015 ed.; Eurocontrol: Brussels, Belgium, 2015.

12. Fricke, H.; Schultz, M. Improving aircraft turn around reliability. In Proceedings of the 3rd ICRAT, Fairfax, VA, USA, 1–4 June 2008; pp. 335–343
13. Fricke, H.; Schultz, M. Delay Impacts onto turnaround performance. In Proceedings of the 8th USA/Europe ATM Seminar, Napa, CA, USA, 29 June–2 July 2009.
14. Schultz, M. (2017). Dynamic change of aircraft seat condition for fast boarding. *Transportation Research Part C*, 85, 131-147.
15. Delcea, C.; Cotfas, L.-A.; Chiriță, N.; Nica, I. A Two-Door Airplane Boarding Approach When Using Apron Buses. *Sustainability* 2018, 10, 3619.
16. Schultz, M. A metric for the real-time evaluation of the aircraft boarding progress. *Transp. Res. Part C Emerg. Technol.* 2018, 86, 467–487.
17. D. C. Nyquist and K. L. McFadden, “A study of the airline boarding problem,” *Journal of Air Transport Management*, vol. 14, no. 4, pp. 197–204, 2008
18. Environmental Law of Ukraine: Textbook for universities / Ministry of Education and Science of Ukraine, National Law Academy of Ukraine named after Yaroslav the Wise; Edited by V. K. Popova, A. P. Hetman.
19. <https://www.icao.int/environmental-protection/CORSIA/Pages/SARPs-Annex-16-Volume-IV.aspx>
20. <https://zakon.rada.gov.ua/rada/show/va037282-99#Text>
21. Developing safety standards for electromagnetic energy: the IEEE International Committee on Electromagnetic Safety (ICES)
22. <https://zakon.rada.gov.ua/rada/show/va042282-99#Text>
23. <https://zakon.rada.gov.ua/rada/show/va037282-99#Text>
24. [https://ledeffect.com.ua/images/\\_\\_branding/dbn2018.pdf](https://ledeffect.com.ua/images/__branding/dbn2018.pdf)
25. <https://zakon.rada.gov.ua/laws/show/z0978-21#Text>
26. <https://zakon.rada.gov.ua/laws/show/z0252-15#Text>

## INITIAL DATA AND SELECTED PARAMETERS

Passenger Number 120  
 Flight Crew Number 2  
 Flight Attendant or Load Master Number 4  
 Mass of Operational Items 1423.26 kg  
 Payload Mass 18468.00 kg

Cruising Speed 850 km/h  
 Cruising Mach Number 0.7966  
 Design Altitude 11.00 km  
 Flight Range with Maximum Payload 4200 km  
 Runway Length for the Base Aerodrome 2.55 km

Engine Number 2  
 Thrust-to-weight Ratio in N/kg 2.800  
 Pressure Ratio 35.00  
 Assumed Bypass Ratio 5.50  
 Optimal Bypass Ratio 5.50  
 Fuel-to-weight Ratio 0.2100

Aspect Ratio 9.00  
 Taper Ratio 2.80  
 Mean Thickness Ratio 0.110  
 Wing Sweepback at Quarter Chord 28.0 deg.  
 High-lift Device Coefficient 1.050  
 Relative Area of Wing Extensions 0.140  
     Wing Airfoil Type - supercritical  
     Winglets - installed  
     Spoilers - installed

Fuselage Diameter 3.90 m  
 Fineness Ratio 9.20  
 Horizontal Tail Sweep Angle 30.0 deg.  
 Vertical Tail Sweep Angle 35.0 deg.

## CALCULATION RESULTS

Optimal Lift Coefficient in the Design Cruising Flight Point 0.40504

Induce Drag Coefficient 0.00901

ESTIMATION OF THE COEFFICIENT  $D_m = M_{\text{critical}} - M_{\text{cruise}}$

Cruising Mach Number 0.79660  
 Wave Drag Mach Number 0.80734  
 Calculated Parameter  $D_m$  0.01074

Wing Loading in kPa (for Gross Wing Area):

    At Takeoff 4.705  
     At Middle of Cruising Flight 4.094  
     At the Beginning of Cruising Flight 4.531

Drag Coefficient of the Fuselage and Nacelles 0.00800  
 Drag Coefficient of the Wing and Tail Unit 0.00903

Drag Coefficient of the Airplane:

    At the Beginning of Cruising Flight 0.02784  
     At Middle of Cruising Flight 0.02688

Mean Lift Coefficient for the Ceiling Flight 0.40504

Mean Lift-to-drag Ratio 15.06886

Landing Lift Coefficient 1.605  
Landing Lift Coefficient (at Stall Speed) 2.407  
Takeoff Lift Coefficient (at Stall Speed) 1.986  
Lift-off Lift Coefficient 1.449  
Thrust-to-weight Ratio at the Beginning of Cruising Flight 0.621  
Start Thrust-to-weight Ratio for Cruising Flight 2.616  
Start Thrust-to-weight Ratio for Safe Takeoff 2.748

Design Thrust-to-weight Ratio 2.858

Ratio  $D_r = R_{cruise} / R_{takeoff}$  0.952

SPECIFIC FUEL CONSUMPTIONS (in kg/kN.h):

Takeoff 34.8553  
Cruising Flight 57.4325  
Mean cruising for Given Range 59.2800

FUEL WEIGHT FRACTIONS:

Fuel Reserve 0.03541  
Block Fuel 0.21368

WEIGHT FRACTIONS FOR PRINCIPAL ITEMS:

Wing 0.13310  
Horizontal Tail 0.01168  
Vertical Tail 0.01151  
Landing Gear 0.04053  
Power Plant 0.08855  
Fuselage 0.08397  
Equipment and Flight Control 0.12914  
Additional Equipment 0.01284  
Operational Items 0.01715  
Fuel 0.24908  
Payload 0.22253

Airplane Takeoff Weight 82992 kg  
Takeoff Thrust Required of the Engine 118.59 kN

Air Conditioning and Anti-icing Equipment Weight Fraction 0.0222  
Passenger Equipment Weight Fraction  
(or Cargo Cabin Equipment) 0.0158  
Interior Panels and Thermal/Acoustic Blanketing Weight Fraction 0.0068  
Furnishing Equipment Weight Fraction 0.0125  
Flight Control Weight Fraction 0.0060  
Hydraulic System Weight Fraction 0.0167  
Electrical Equipment Weight Fraction 0.0322  
Radar Weight Fraction 0.0031  
Navigation Equipment Weight Fraction 0.0047  
Radio Communication Equipment Weight Fraction 0.0023  
Instrument Equipment Weight Fraction 0.0054  
Fuel System Weight Fraction 0.0073

Additional Equipment:

Equipment for Container Loading 0.0078  
No typical Equipment Weight Fraction  
(Build-in Test Equipment for Fault Diagnosis,  
Additional Equipment of Passenger Cabin) 0.0050

TAKEOFF DISTANCE PARAMETERS

Airplane Lift-off Speed 259.33 km/h  
Acceleration during Takeoff Run 2.16 m/s  
Airplane Takeoff Run Distance 1195 m  
Airborne Takeoff Distance 578 m  
Takeoff Distance 1774 m

CONTINUED TAKEOFF DISTANCE PARAMETERS

Decision Speed 246.36 km/h  
Mean Acceleration for Continued Takeoff on Wet Runway 0.21 m/s\*s  
Takeoff Run Distance for Continued Takeoff on Wet Runway 2256.56 m  
Continued Takeoff Distance 2834.94 m  
Runway Length Required for Rejected Takeoff 2938.15 m

LANDING DISTANCE PARAMETERS

Airplane Maximum Landing Weight 69050 kg  
Time for Descent from Flight Level till Aerodrome Traffic Circuit Flight 21.8 min  
Descent Distance 51.38 km  
Approach Speed 241.75 km/h  
Mean Vertical Speed 1.96 m/s  
Airborne Landing Distance 514 m  
Landing Speed 226.75 km/h  
Landing run distance 707 m  
Landing Distance 1220 m  
Runway Length Required for Regular Aerodrome 2038 m  
Runway Length Required for Alternate Aerodrome 1733 m

ECONOMICAL EFFICIENCY

THESE PARAMETERS ARE NOT USED IN THE PROJECT

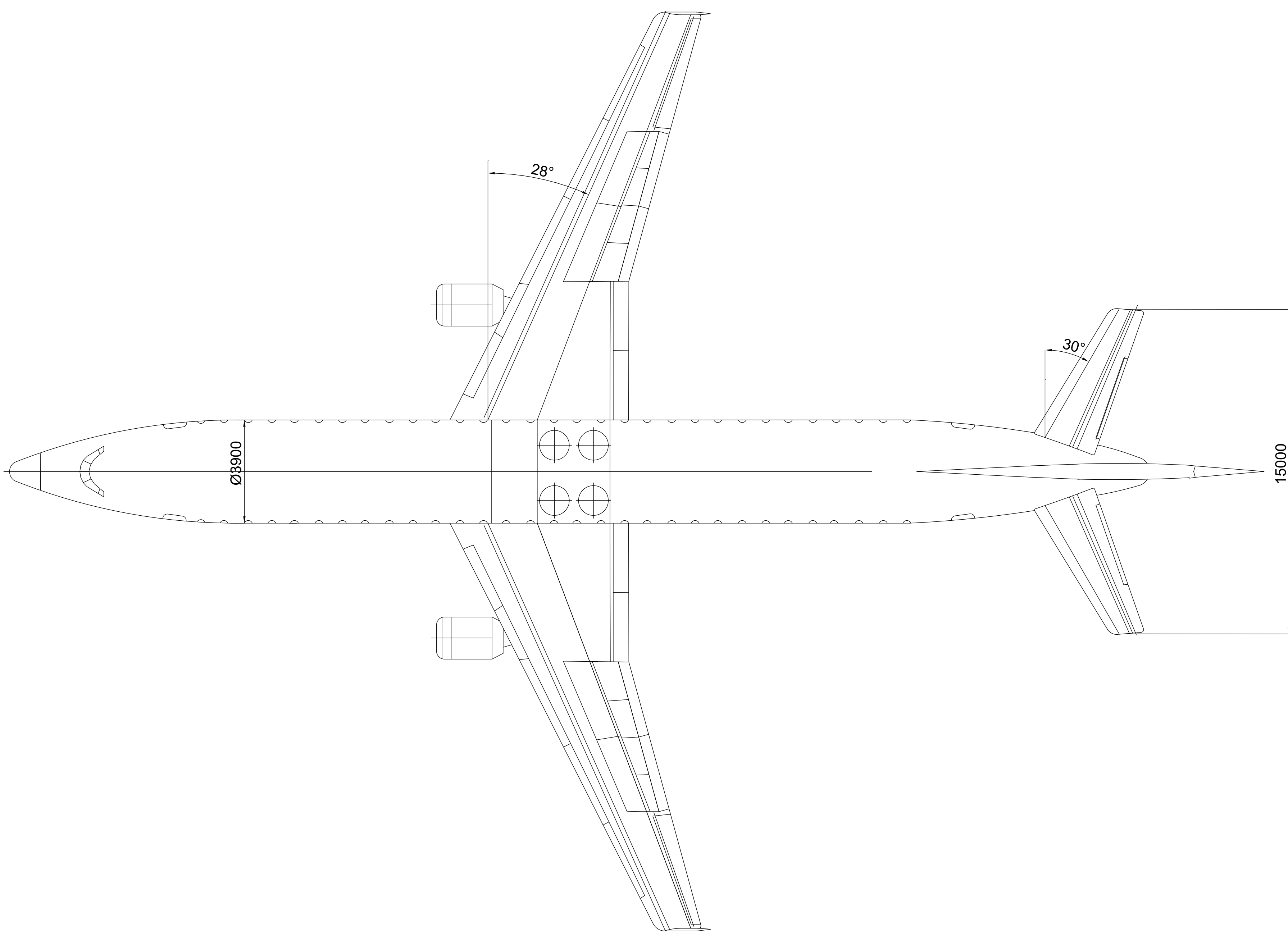
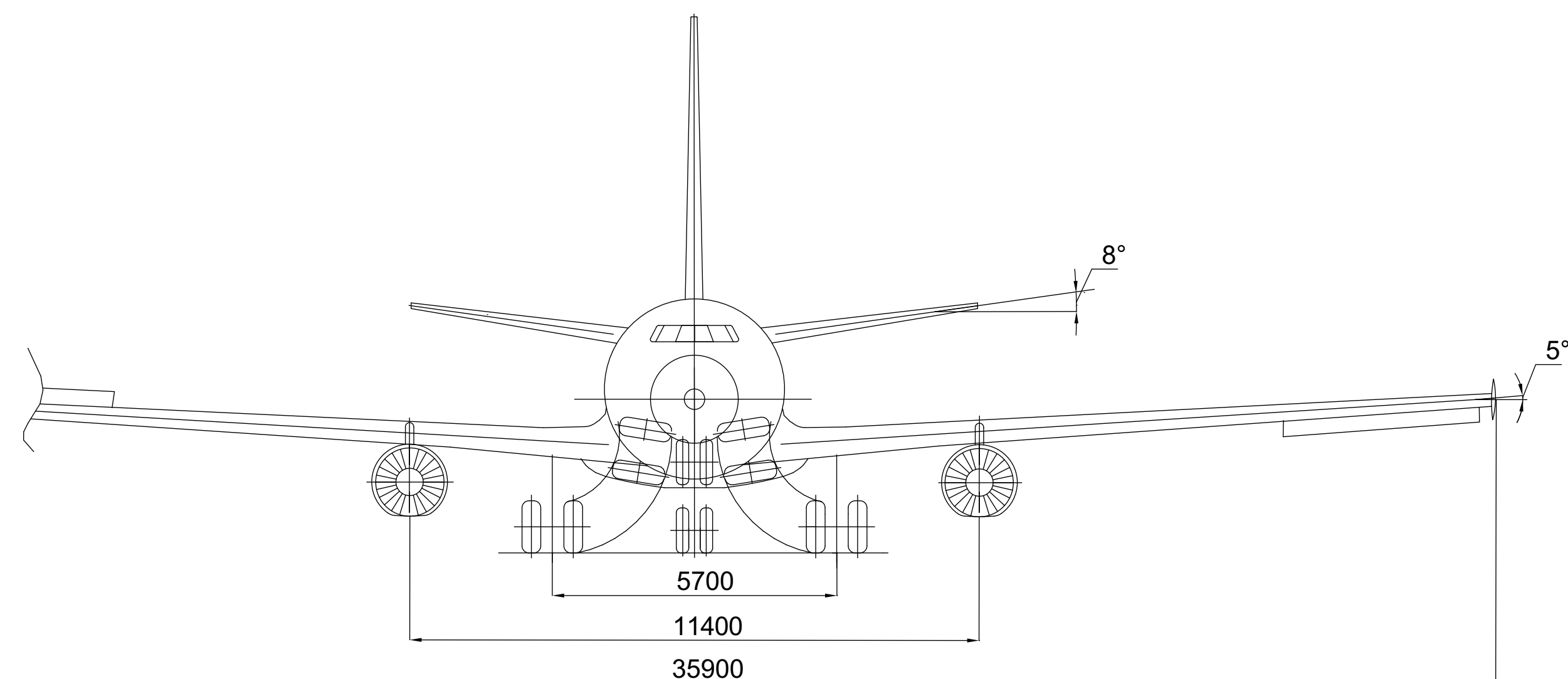
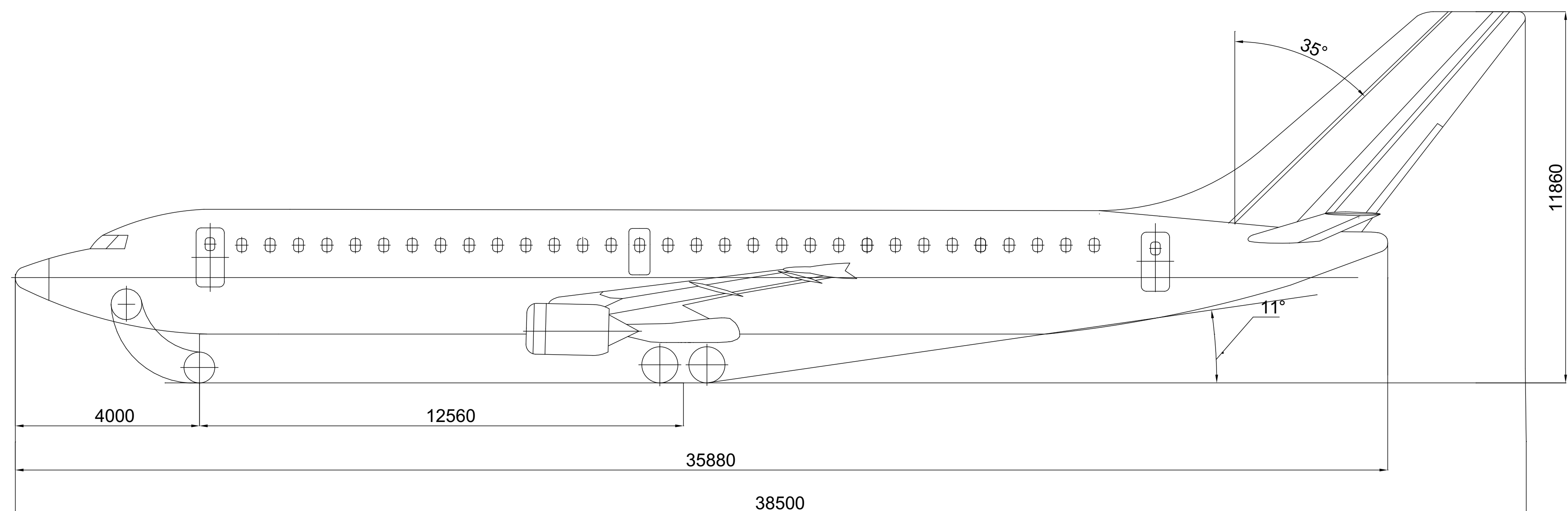

N	Main data of the aircraft	Unit of measure	Value
<u>Geometry data</u>			
1	Wing span	m	35,9
2	Wing area	m	143
3	Airplane length	m	39,9
4	Aircraft height	m	11,86
5	Wing extension	-	9
6	Wing taper	-	2,8
7	Average aerodynamic chord	m	4,3
<u>Mass data</u>			
1	Takeoff weight	kg	82992
2	Weight of an empty, loaded airplane	kg	
3	Payload	kg	18468
4	Fuel weight	kg	20671
<u>Flight characteristics</u>			
1	Cruising speed	km/h	850
2	Flight range	km	900
3	Runway length	m	4200
4	Take-off speed	km/h	260
5	Approach speed	km/h	240
6	Takeoff distance	m	2835
7	Landing distance	m	1220
<u>Powerplant data</u>			
1	Engine type	-	CFM56
2	Number of motors	units	2
3	Thrust capacity	N/kg	2,8
4	Specific fuel consumption	(kg/h)/kgs	0,545
<u>Efficiency data</u>			
1	Weight of empty aircraft per passenger	kg/pass.	264,15
2	Capacity	(kg/km)/h	14799
3	Fuel consumption per tonne-kilometer	g/t*km	228,627
4	Fuel consumption per passenger-kilometer	g/pass.*km	22,99
5	Average hourly fuel consumption	kg/h	3383,5
6	Average fuel consumption per kilometer	kg/km	4,22

Department of aircraft design					NAU 22 02H 00 00 00 33 GV			
Ch.	List	No of document	Sign	Data	Mid-range passenger plane (general view)	Lit.	Mass	Scale
Designed by		Horian I.						1:100
Checked by		Maslak T.				List 1		Lists 4
Reviewer								
Stand. insp.		Krasnopolskiy V.			APPENDIX B			
Head of dep.		Ignatovych S.						



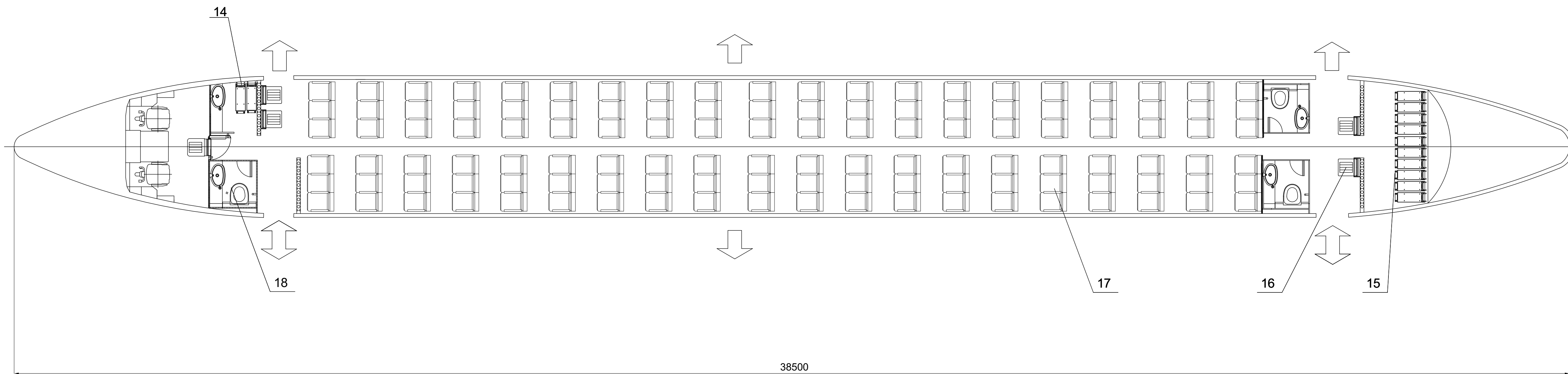
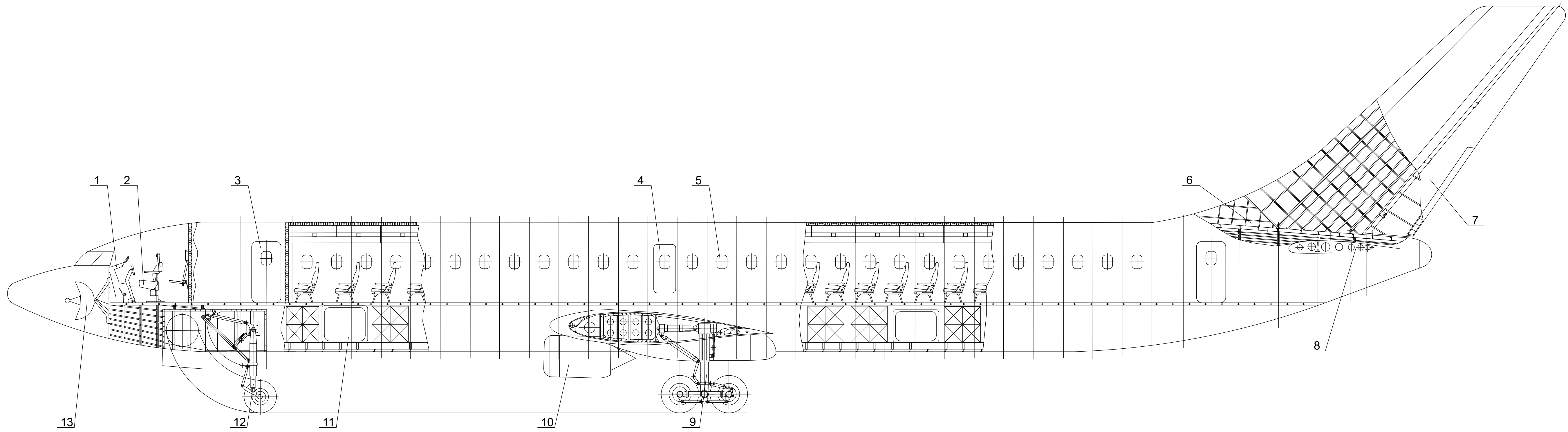

External Area	Position	Marking	Name	QTY	Note
	1	NAU 22 02H 75 10 00	Control panel	1	
	2	NAU 22 02H 75 20 00	Pilot's seat	2	
	3	NAU 22 02H 75 30 00	Front door	2	
	4	NAU 22 02H 75 40 00	Emergency exit	4	
	5	NAU 22 02H 75 50 00	Illuminator	34	
	6	NAU 22 02H 34 00 00	Keel	1	
	7	NAU 22 02H 33 00 00	Rudder	1	
	8	NAU 22 02H 31 00 00	Stabilizer	1	
	9	NAU 22 02H 41 00 00	Main landing gear support	2	
	10	NAU 22 02H 60 00 00	Power plant	2	
	11	NAU 22 02H 75 60 00	Cargo compartment	2	
	12	NAU 22 02H 42 00 00	Front landing gear support	1	
	13	NAU 22 02H 71 00 00	Locator	1	
	14	NAU 22 02H 75 70 00	Buffet	1	
	15	NAU 22 02H 75 70 00	Galley	1	
	16	NAU 22 02H 75 80 00	Flight attendant's seat	4	
	17	NAU 22 02H 75 90 00	Ec. class pass. seat	120	
	18	NAU 22 02H 78 00 00	Lavatory	3	

Department of aircraft design					NAU 22 02H 00 00 33 LA			
Ch.	List	Nr of document	Sign	Date	Passenger medium-range aircraft (layout)	Lit.	Mass	Scale
Designed by		Horian I.						1:50
Checked by		Masiak T.				List 2	List 3	
Reviewer								
Stand. insp.		Krasnopolskiy V.			APPENDIX C			
Head of dep.		Ignatovych S.						