

MINISTRY OF EDUCATION AND SCIENCE OF UKRAINE
NATIONAL AVIATION UNIVERSITY
Faculty of Transport, Management and Logistics
Logistics Department

APPROVED
Head of the Department

Matveev V.V.
(signature, surname and name)
«07» November 2022

DIPLOMA THESIS

(EXPLANATORY NOTES)

OF GRADUATE OF ACADEMIC DEGREE

«MASTER»

THEME: **«Improving the information interaction of supply chain participants»**

Speciality 073 «Management»

Educational and Professional Program « Logistics »

Done by Dostatnii R.R.
(surname and name) (signature, date)

Supervisor Pozniak O.V.
(surname and name) (signature, date)

Standards Inspector Kaban N.D.
(surname and name) (signature, date)

Kyiv 2022

МІНІСТЕРСТВО ОСВІТИ І НАУКИ УКРАЇНИ
НАЦІОНАЛЬНИЙ АВІАЦІЙНИЙ УНІВЕРСИТЕТ
Факультет транспорту, менеджменту і логістики
Кафедра логістики

ЗАТВЕРДЖУЮ
Завідувач кафедри логістики
Матвеев В.В.
(підпис, П.І.Б)
«07» листопада 2022 р.

КВАЛІФІКАЦІЙНА РОБОТА

(ПОЯСНЮВАЛЬНА ЗАПИСКА)

ЗДОБУВАЧА ОСВІТНЬОГО СТУПЕНЯ

«МАГІСТР»

ТЕМА: «Удосконалення інформаційної взаємодії учасників ланцюга постачання»

зі спеціальності 073 «Менеджмент»
(шифр і назва)
освітньо- професійна програма «Логістика»
(шифр і назва)

Здобувач: Достатній Роман Русланович
(прізвище, ім'я та по батькові) (підпис, дата)

Науковий керівник: Позняк О.В.
(прізвище та ініціали) (підпис, дата)

Нормоконтролер: Кабан Н.Д.
(прізвище та ініціали) (підпис, дата)

Київ 2022

NATIONAL AVIATION UNIVERSITY
Faculty of Transport, Management and Logistics
Logistics Department

Academic degree Master

Speciality 073 «Management»

Educational and Professional Program « Logistics »

APPROVED
Head of the Department

Matveev V.V.
(signature, surname and name)
«05» September 2022

TASK

FOR COMPLETION THE DIPLOMA THESIS OF GRADUATE

Dostatnii Roman

(surname and name)

1. Theme of the diploma thesis: « Improving the information interaction of supply chain participants» was approved by the Rector Directive №1225/CT. of September 05, 2022.
2. Term performance of thesis: from September 05, 2022 to November 30, 2022.
3. Date of submission work to graduation department: November 07, 2022.
4. Initial data required for writing the thesis: general and statistical information analysis of information system, general information of the company «DSV», production and financial indicators of the company «DSV», literary sources on logistics and IT in logistics, Internet source.
5. Content of the explanatory notes: introduction, the concept and types of clients of a logistics company; information systems in logistics; problems of implementation of information systems for interaction with clients; analysis the financial indicators of the logistics company «DSV»; analysis of «DSV» company's clients; development of a customer relationship management system; calculation of project performance indicators; conclusions and recommendation .
6. List of obligatory graphic matters: tables, charts, graphs, diagrams illustrating the current state of problems and methods of their solution.

7. Calendar schedule:

№	Assignment	Deadline for completion	Mark on completion
1	2	3	4
1.	Study and analysis of scientific articles, literary sources, normative legal documents, preparation of the first version of the introduction and the theoretical chapter	05.09.22-28.09.22	Done
2.	Collection of statistical data, timing, detection of weaknesses, preparation of the first version of the analytical chapter	29.09.22-10.10.22	Done
3.	Development of project proposals and their organizational and economic substantiation, preparation of the first version of the project chapter and conclusions. Editing the first versions of master thesis	11.10.22-28.10.22	Done
4.	Preparing the final version of the master thesis, checking by standards inspector	29.10.22-02.11.22	Done
5.	Approval for a work with supervisor, getting of the report of the supervisor, getting internal and external reviews, transcript of academic record	03.11.22-06.11.22	Done
6.	Submission work to Logistics Department	07.11.22	Done

Graduate _____
(signature)

Supervisor of the diploma thesis _____
(signature)

8. Consultants of difference chapters of work:

Chapter	Consultant (position, surname and name)	Date, signature	
		The task was given	The task was accepted
Chapter 1	Associate Professor, Pozniak O.V	05.09.22	05.09.22
Chapter 2	Associate Professor, Pozniak O.V.	29.09.22	29.09.22
Chapter 3	Associate Professor, Pozniak O.V	11.10.22	11.10.22

9. Given date of the task September 05, 2022.

Supervisor of the diploma thesis: _____
(signature of supervisor)

Pozniak O.V
(surname and name)

Task accepted for completion: _____
(signature of graduate)

Dostatnii R.R.
(surname and name)

ABSTRACT

The explanatory notes to the diploma thesis «Improving the information interaction of supply chain participants» comprises of 101 pages, 34 figures, 23 tables, 78 references.

KEYWORDS: INFORMATION FLOW, PARTICIPANT, SUPPLY CHAIN, LOGISTICS COMPANY, IT SYSTEMS, IMPROVEMENT, CUSTOMERS, WAREHOUSE REAL ESTATE, LOGISTICS OPERATORS

The purpose of the study is to further develop the theoretical and practical aspects of improving the information interaction of supply chain participants for effective work in a competitive environment.

The subject of the study is a set of theoretical and practical problems related to the organization of the information interaction within supply chain with different participants.

The object of research is forms of information interactions between LLC DSV Logistic and supply chain participants.

Research methods - scientific search, empirical, analysis and synthesis, modeling, expert estimates, extrapolation of time series.

Diploma thesis consists of three chapters, introduction, conclusions and recommendations.

The materials of the diploma thesis are recommended for use in scientific research, in the educational process and in the practical work of logistics specialists.

CONTENTS

	page
NOTATION.....	7
INTRODUCTION.....	8
CHAPTER 1. THEORETICAL BASIS OF INFORMATION INTERACTION OF SUPPLY CHAIN PARTICIPANTS.....	11
1.1. The concept of information flow in the supply chain.....	11
1.2. Types of interaction between participants in supply chains.....	18
1.3. Information technologies used to support the interaction of supply chain participants.....	26
1.4 Chapter 1 summary.....	35
CHAPTER 2. ANALYSIS OF INFORMATIONAL INTERACTION OF LLC DSV LOGISTICS IN SUPPLY CHAIN.....	37
2.1. General characteristics of the company.....	37
2.2. Analysis of the financial indicators of the company.....	44
2.3 Analysis of interaction between the company and supply chain participants.....	54
2.4 Chapter 2 summary.....	59
CHAPTER 3. PROJECT PROPOSALS FOR IMPROVING THE INFORMATIONAL INTERACTION OF SUPPLY CHAIN PARTICIPANTS.....	60
3.1 Development of directions for improving the information interaction between LLC DSV LOGISTICS and supply chain participants.....	60
3.2 Development of the CRM implementation project.....	66
3.3 Calculation of project performance indicators.....	77
3.4 Chapter 3 summary.....	87
CONCLUSIONS AND RECOMMENDATIONS.....	89
REFERENCES.....	92
APPENDIX A.....	100

NOTATION

APS	– Advanced Planning System
AGIL	– Agility’s Global Integrated Logistics
BPR	– Business Process Reengineering
CRM	– Customer Relationship Management
CSCM	– Customer Service Chain Management
CPFR	– Collaborative Planning, Forecasting, and Replenishment
CBPR	– Construction Business Process Reengineering
DSV	– De Sammensluttede Vognmænd
DKK	– Danske Kroner
ERP	– Enterprise Resource Planning
EBIT	– Earnings Before Interest and Taxes
HQ	– Headquarter
IF	– Information Flows
IT	– Information Technology
LS	– Logistic System
LC	– Logistics Company
LLC	– Limited Liability Company
MIS	– Management Information Systems
MR	– Material Resources
MRP	– Material Requirements Planning
NPV	– Net Present Value
PL	– Provider Logistics
SCM	– Supply Chain Management
SRM	– Supplier Relationship Management
SCEM	– Supply Chain Event Management
UEI	– Unified Information Space
VMI	– Vendor Managed Inventory

INTRODUCTION

Market conditions of business determine information and contractual relations as the basic attributes of doing business. Business information support forms the enterprise's communications system as an open system, on the basis of which the enterprise's operating environment is formed, where its employees interact with suppliers, consumers, intermediaries, and partners. The system of setting up such interactions is determined by the information interaction of the enterprise, the formation and management of which is a complex, time-consuming and relevant process in the market conditions of business.

Information interaction is an important and necessary component of the management system to ensure the development of the enterprise, on which the effectiveness of the entire team depends. A key role is played by the quality of information flows that form the basis of communication policy. At the same time, attention should be paid to maintaining the optimal ratio between the results obtained and the costs of information interaction activities.

Modern trends in the practice of managing relations in the supply system, which are formed under the influence of many macro- and microeconomic factors both in Ukraine and abroad and are accompanied by the emergence of various problems, as well as the weak development of scientific research in the field of management of such complex economic systems as the supply chain taking into account the specifics of the domestic economy, encourage specialists to pay more and more attention to both conceptual and applied aspects of this management.

In modern economic conditions, an important factor in the success of enterprises is the rapid exchange of information, as well as its rapid collection and processing for making effective management decisions. In order to quickly receive an order or transfer data about the necessary products, there must be a circulation of information everywhere. The value of information in product supply chains consists in its use from

the moment of placing the order until the receipt of the goods and further cooperation with business partners and with all links of the supply chain.

Analysis of the latest studies, in which the solution to the problem was initiated. The following domestic and foreign scientists made a significant contribution to the research of information interaction in modern conditions: Afanasyev M.V., Burnet J., Hirnyak O.M., Golubkova O.M., Griffin R., Yatsura V., Ivashchenko V. I., Kovalchuk T.M., Kotler F., Meskon, Michael H., Noritsyna N.I., Oklander M.A., Pylypenko A.A., Pylypenko S.M., Otenko V.I., Primak T. O., Romat E. V., Khmarska I. A. and others.

The purpose of the study is to further develop the theoretical and practical aspects of improving the information interaction of supply chain participants for effective work in a competitive environment.

To achieve this purpose such tasks should be done:

- to find out the essence and functions of information interaction in supply chain;
- to characterize the process of information interaction of supply chain participants;
- to systematize the experience of using information programs for the interaction of supply chain participants;
- to investigate the informational interaction of the participants of the company's supply chain;
- to evaluate the effectiveness of information interaction of enterprise participants;
- to develop directions for improving the information interaction of the participants of the company's supply chain;
- to propose the project for implementation of a CRM system;
- to evaluate the effectiveness of the proposed measures.

The subject of the study is a set of theoretical and practical problems related to the organization of the information interaction within supply chain with different participants.

The object of research is forms of information interactions between DSV Logistic LLC and supply chain participants.

Research methods. In the process of writing the thesis, general scientific and empirical methods of research were used, in particular, methods of analysis and synthesis - in the study of the genesis of the economic entity and the scope of application of the category "information interaction"; method of systematization - when systematizing information interaction in the supply chain; methods of economic analysis - when assessing information interaction; tabular - to present calculations and evaluate specific research results.

When writing the thesis, we used foreign and domestic literary sources on the chosen topic, statistical data on the financial activities of the logistics company and Internet sources.

Structurally, the thesis consists of an introduction, three chapters, conclusions, a list of used sources and appendices.

CHAPTER 1

THEORETICAL BASIS OF INFORMATION INTERACTION OF SUPPLY CHAIN PARTICIPANTS

1.1 The concept of information flow in the supply chain

The foundation of logistics and SCM from the perspective of management, controlling and making optimization decisions in the supply chain is information. The concept of information in logistics is multifaceted: it is information and telecommunication systems and technologies, global computer networks, corporate integrated and local logistics support systems, electronic business, electronic document management, etc. One of the most important purposes of management of information flows in logistics is to help logisticians to choose and use information resources, using which they can make better decisions regarding the management of logistics processes in supply chains [1, p. 25].

Information as an object of management in logistics is transformed into the concept of information flow, emphasizing the dynamics of receiving and transforming information and the connection with the material flow or services [2, p. 9].

In the internal economic sphere of the enterprise, every employee is a generator or recipient of the flow of information, regardless of his place in the organizational structure or qualification level. Generators and recipients of external flows of information — natural and legal entities that are in informational interaction with this economic structure [3, p. 7].

Information Flows (IF) is a flow of messages and data in speech, document (paper and electronic) and other forms, accompanying a material flow and/or process of rendering services in the considered LS (supply chain) and intended for realization of administrative functions.

The classification of Information Flows is shown in Fig. 1.1.

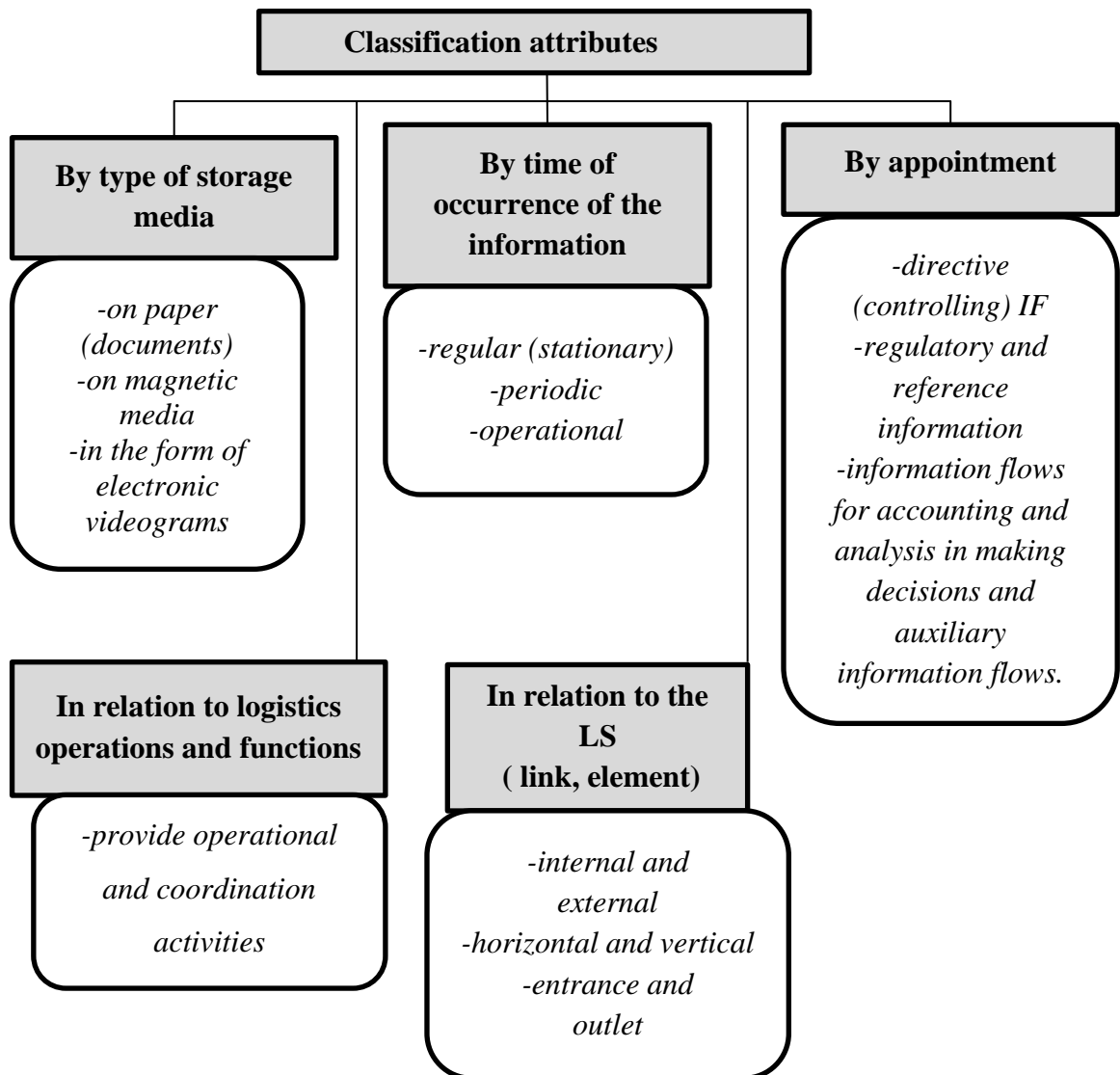

Figure 1.1 - Classification of information flows in logistics

Information flows provide direct and feedback to their generator, which positively affects the effectiveness of management decisions. Data is perceived by the receiver as information in the case when his "memory" contains concepts and models that allow understanding the content of the received information [8, p. 9]. That is why there is a need for feedback between horizontal and vertical levels of management to avoid excessive information flows and ensure their proper quality.

An important aspect of information flow characteristics is its difference from document circulation. According to VI Kunchenko-Kharchenko, document circulation characterizes the movement of only internal documented information about economic processes [4, p. 175]. Information flows are much broader in purpose and ensure not

only the circulation of orderly internal business documentation in the information system of the enterprise [9, p. 121]. In addition, the information flow can have both a documented form and an undocumented (unofficial) form, which depends on the nature of the communication exchange within the organizational structure of the enterprise and in its interaction with the external environment.

The characteristics of information flows are also the direction, structure, time period of their functioning.

The direction of the information flow as the movement of information through communication channels is determined by the purposefulness of the data being transmitted. Reaching the addressed position (recipient) is ensured by a clear regulation of the flow direction, which greatly simplifies movement along organizational routes and reduces operating time costs. The direction of the information flow determines the permanent communication link between the person who makes the economic decision and the person who forms his information support [13, p. 33].

The structure of the information flow is determined by the nature of the information content and is a combination of arrays of information messages (written documented information, oral messages) as structural units of information [11, p. 330]. The syntactic structural construction of the information flow must take into account the relationship between information elements, the possibility of its semantic interpretation, as well as ensuring the unity of the user with the information [7, p. 74]. Connections are established between the components of the information flow on the basis of joint movement from the addresser to the addressee, forming a complete system.

The information flow differs from the sum of individual structural parts, and this phenomenon, according to the systemological concept and the law of synergism, indicates a high level of organization and, accordingly, contributes to increasing the overall effectiveness of the enterprise [10, p. 4].

The time of functioning of the information flow is determined by the term from the beginning of the generation of the information content of the flow until it is received by the person who initiated the information request, or is the recipient of the

information flow without a prior request. The passage of the information flow from the source of formation to the consumer is regulated by time, which is determined by certain terms of the business plan, current regulatory norms, the need for timely submission of reports and management decisions.

The quality of information flows largely depends on the quality of the information they provide. Accordingly, the functioning of information flows will contribute to the economic performance of the enterprise under the conditions of ensuring the quality characteristics of information, in particular, reliability, accuracy, objectivity, relevance, usefulness, relevance. Speed, discreteness, intensity, capacity, density, multifunctionality are the specific features that characterize the movement of information flows of the enterprise.

The importance of information exchange for the process of making management decisions is determined by the clearly established regulation of the time limits of information movement, namely its speed. The maximum amount of information received in the minimum amount of time is evidence of the efficiency of the economic system, its ability to flexibly, timely and adequately respond to external and internal signals. Providing business processes with high-speed information flows is a prerequisite for obtaining a significant competitive advantage, in particular, due to the prompt implementation of intellectual achievements and creative ideas of employees and partners.

The information flow is characterized by discreteness, which consists in the internal structuring and ordering of data within its limits [3, p. 30]. Dividing the stream into separate components (informational parts) allows you to identify likely qualitative and quantitative changes in information, the degree of interconnection of informational units.

The discreteness of the information flow indicates the participation of each information generator in the created information flow, the peculiarities of the division of labor, the uniformity of the information load and the functional responsibility of employees. Discretion of the information flow allows you to control the individual

work of employees, purposefully and effectively use information technologies, and actively manage the use of information resources.

The degree of use and speed of movement of information flows determine their intensity. The optimally constructed organizational structure of the enterprise, successfully established business relations with counterparties, active work of marketing and information departments contribute to high intensity, regularity of information flows and constant information provision of business processes in conditions of dynamism and variability of external influencing factors. The completeness of the information flow is assessed by capacity. Capacity for information flow is the potentially possible volume of data and information transmitted in one direction. The density of the information flow is determined by the depth of the communication exchange, which involves the maximum amount of information resources of the enterprise [2, p. 224; 12, p. 168].

Information flows are characterized by multifunctionality, because they function in business processes with various goals and provide an information basis for management decisions, professional knowledge of employees, regulatory and legal documents of the enterprise, analytical studies, processes of development and implementation of new products, processes of creating and maintaining the market image of the enterprise, maintaining economic security and formation of business development prospects.

The variety of functions performed by information flows, as well as their areas of application, allow us to determine the classification types of flows (Table 1.1).

Table 1.1 – Types of information flows

Type of classification	Type of information flow
Thematic orientation of the content	Monothematic, polythematic
Specialization of use	Single, multi-disciplinary
The sphere of circulation	Internal, conditionally internal, external
The direction of movement relative to the enterprise	Outbound, inbound
The method of obtaining information from the external environment	Independent, mediated
Information data period	Planned, current, retrospective
Officialism	Official, unofficial

End of table 1.1

Scale of action	International, national, local
Belonging to the participants of the information exchange	Direct, reverse
Management level	Vertical, horizontal
The form of information carriers	Material, electronic, oral, combined
Reliability	Reliable, risky, unreliable
Degree of identification	Identified, partially identified, not identified
Frequency of occurrence	One-time, periodic, permanent
Structure	Simple, complex

Information flows create a basis for the information interaction of various participants in the supply chain to ensure the smooth movement of the material flow, the information interaction between the participants of the supply chain must be effective and in a real-time system, since all participants work in conditions of an unstable, rapidly changing external environment.

Accordingly, supply chain management is a systematic approach to planning and managing the flow of information, materials and services at all stages of the movement of goods from the producer to the final consumer. The information flow accompanies all accompanying flows in supply chains (see Fig. 1.2), and in some cases precedes it, since information about the movement of cargo can arrive before its physical arrival.

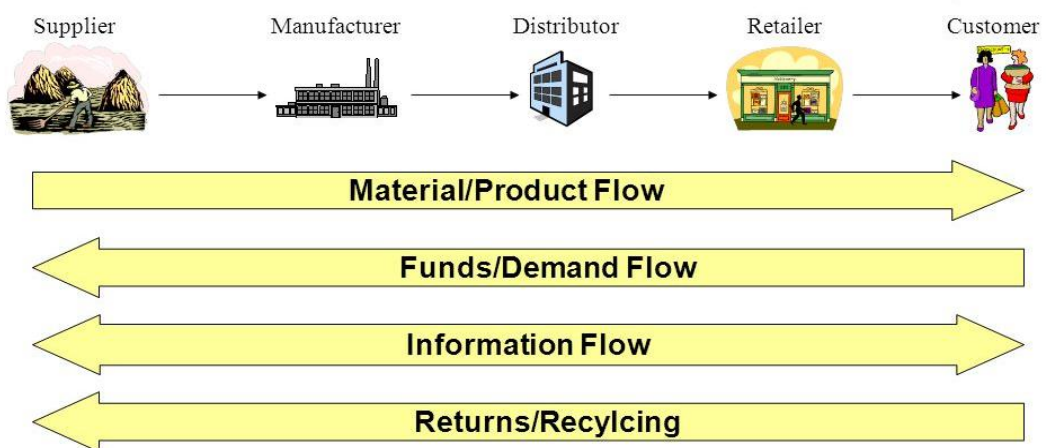

Figure 1.2 – Place of information flow in Supply Chain

The information flow is the movement of information that reflects the dynamics of the promotion of goods and is recorded in the vast majority of such documents as

goods and transport invoices, invoices, other profit and loss documents for goods and containers, acts, certificates, registers, orders, goods reports, reports on the movement of goods, cash reports. The main goal of the formation of information flows in logistics systems is to provide the management body of the enterprise with the data necessary for the optimization of management decisions. The means of achieving this goal are the application of a complex of modern technical means and the use of administrative, organizational, and economic-mathematical methods and the creation of automated supply chain management systems on this basis, which would cover all participants in the logistics chain [33, p. 54].

The basis of the modern development of supply chain management is increasing the importance of information. The use of information in supply chains is aimed at ensuring a quick and correct exchange of information between partners about real and forecasted demand from customers, about changes in stocks, about transport and storage capacities.

The purpose of such an exchange is to replace physical stocks with information about them. With the help of information technology tools for managing supply chains, today it is possible to perform most of the functions related to the solution of tasks related to the management of the entire supply chain. That is why it is noted that information is the main element of any of the management functions.

Having complete, reliable, up-to-date and operational information provides market advantages and reduces financial risk, effectively supports decision-making. In the presence of complete information, it becomes possible to make rational management decisions.

Therefore, a management system of any level of complexity can function only if information circulates in it, and therefore the management process, in particular the organization of supply chains, is primarily an information process that ensures the performance of the functions of collecting, transmitting, processing, analyzing data and accepting reasonable decisions based on the received information.

The information needs of the supply chain arise in accordance with the sequential execution of the stages of order implementation: demand, order, stock status,

production, delivery, qualified personnel, purchasing department, control of order fulfillment, planning, solving operational problems, the guarantee of the fulfillment of which in the parameters "quantity-quality- price-place-time" completely depend on the presence of an integrated information system of all links of the logistics chain (suppliers, manufacturers, distributors, carriers, logistics operators), and on all resources (material, financial, human, informational).

If SCM is a continuation and development of the concept of integrated logistics in terms of interfunctional and interorganizational coordination, interaction of supply chain subjects, then it is necessary to determine what types of interaction occur between participants of the supply chain

1.2 Types of interaction between participants in supply chains

Before determining the types of interactions that occur in supply chains, it is necessary to determine the participants of supply chains themselves, who need to form and ensure certain business relationships.

Participants (contractors) of the supply chain form the so-called "three parties" in the logistics of the company, and the company that forms the LS is sometimes called the central (focal) company of the supply chain or the "master" of the logistics process.

These three parties (for industrial and trading companies) are as follows (Fig. 1.3):

- 1st party — suppliers (MR and GP);
- 2nd party — users of the GP;
- 3rd party — logistics intermediaries.

In the foreign practice of logistics management, the term "Third Party Logistics" (3PL) is used to designate a logistics intermediary.

Carriers, freight forwarders, cargo terminals, warehouse operators and other legal entities or individuals performing basic logistics functions or a set of such

functions are the main logistics intermediaries for a company — a producer of goods or a trading company.

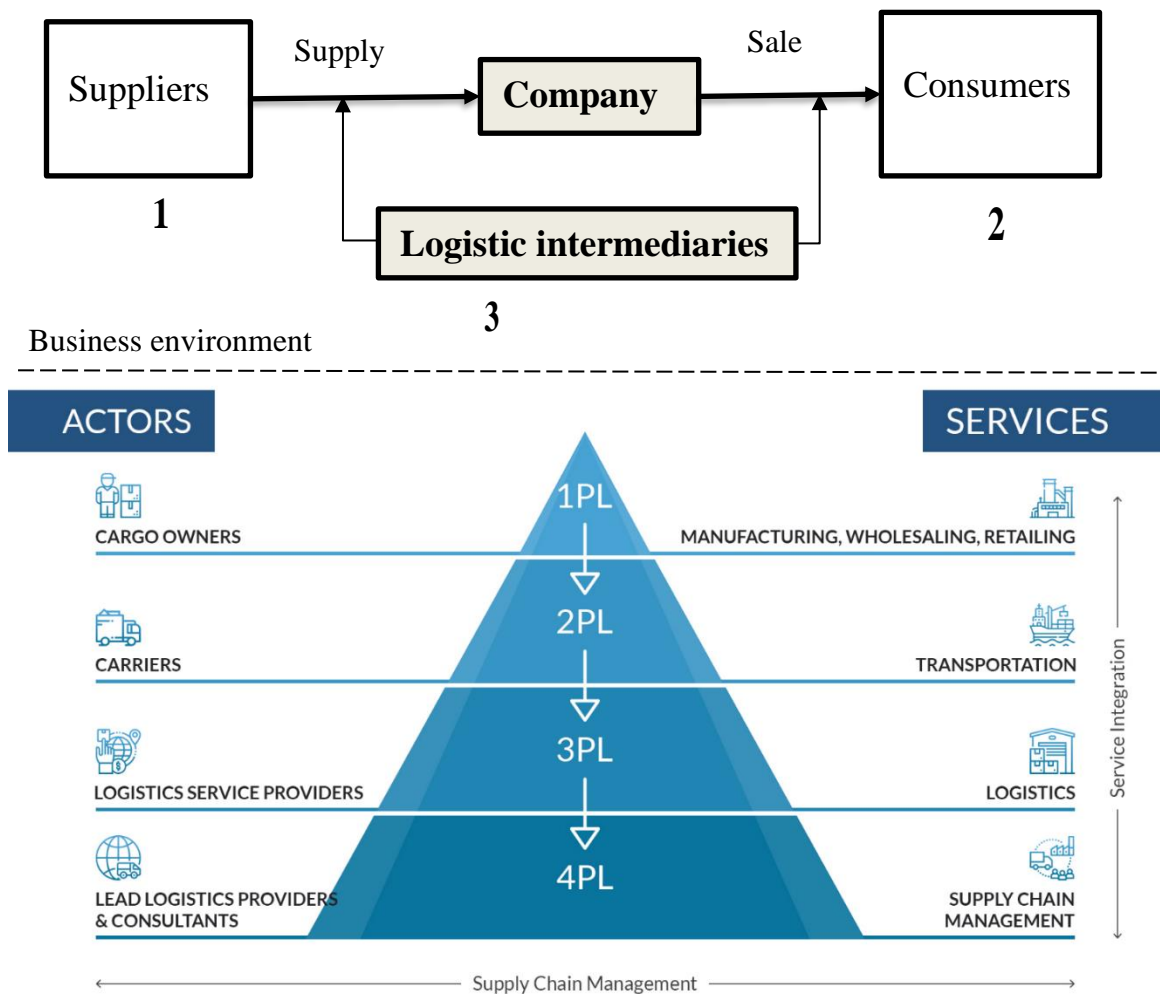

Figure 1.3 – The main participants of Supply Chain [77]

Auxiliary logistics intermediaries usually include insurance and security firms, customs brokers, surveyors, banks, other financial institutions that perform calculations for logistics functions/operations, information-computer service and communication companies, etc.

Companies that provide complex logistics services to consumers are called logistics operators or providers of complex logistics services.

A large number of participants in the supply chain need to form and ensure effective interaction to minimize the loss of time, resources and risks, financial losses that occur in the process of movement of material and related flows.

First of all, the process of interaction is presented as a set of procedures that are performed continuously and consistently, with the help of which partnership relations are formed and implemented. At the same time, the development of such relations involves the use of a strategy of increasing the value of consumers, aimed at intensifying their purchases and increasing profitability due to adaptation to the reaction of consumers to marketing incentives, ensuring a high level of service at the enterprise, improving the logistics service complex, etc. To ensure effective interaction with business partners, enterprises need to solve the following optimization tasks at each stage of relationship organization [44, p. 2]:

- assessment of the competitive strength of supply chain participants by aspects: managerial, marketing, logistic, economic, production-technological, social-behavioral and others;
- assessment of competence of supply chain participants by characteristics: ability to integrate, ability to adapt, ability to communicate;
- development of a matrix for the formation of an optimal portfolio of relationships with business partners;
- formation of a set of strategies for working with potential and real participants in the supply chain;
- identification of goals of supply chain subjects;
- study of the motivational field of interaction subjects and assessment of priority incentives for partnership;
- development of measures that provide a motivating influence on the processes of interaction into a single complex that activates the process of achieving the goals of each of the partners;
- formation of an information technology architecture that ensures synchronization of key business processes of strategic interaction;
- choosing the optimal technology for managing flow processes of enterprises participating in partnership interaction.

The activity of forming, maintaining and developing long-term mutually beneficial relations with consumers, business partners and competitors, aimed at

ensuring the most complete satisfaction of consumer needs, contributes to the achievement of the goals of each of the partners and the acquisition of competitive advantages.

In general, the term "partnership" is a legal form of organizing the joint economic activity of several individuals or legal entities; the term "interaction" is a mutual connection between objects in action, as well as an agreed action between someone, something [51, p. 5].

The term "interaction" is used in various fields of science, and its interpretation depends on the subject and direction of research. Therefore, the concept of "interaction" is characterized by the presence of actual, effective and relatively stable connections that allow objects to influence each other, as well as the presence of the influence itself, the result of which is a mutual change of objects.

At the same time, the terms "cooperation" and "cooperation" are used simultaneously. In the dictionary of the Ukrainian language, cooperation is interpreted as a joint activity, joint actions, and cooperation - as a joint activity with someone. "Cooperation" can be interpreted as a process of interaction between two or more participants, in which the use of "coercion" is excluded and joint searches for the realization of common interests dominate. In this context, it is necessary to analyze the term "partnership" as one of the types of interaction based on the expectation that the partner will behave in accordance with the terms of cooperation during the interaction.

A generalization of the definitions of the set of concepts that condition partnership relations in the supply chain are shown in fig. 1.4.

Partnership in the modern sense is a type of relationship between different subjects, which consists in forming a single position on certain issues and organizing joint actions. The specificity of partnership is the preservation of relative independence by each of the partners in the main aspects of activity. Therefore, partnership as a type of joint activity in supply chains consists in the equality of its participants, which implies equal rights and obligations of each of the parties, and therefore mutual responsibility.

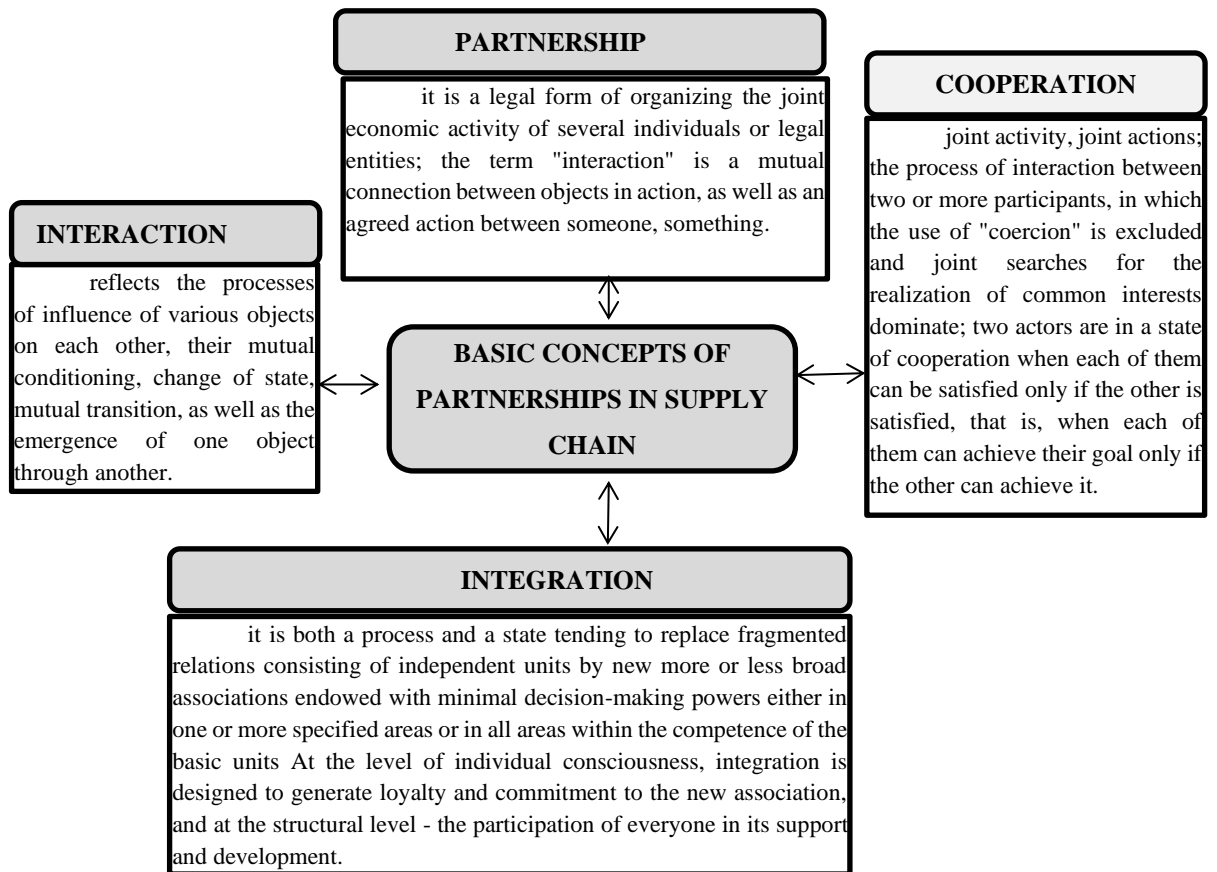

Figure 1.4 - Basic concepts revealing the meaning of partnership relations in supply chains

Management of the supply chain in conditions of competition is built on the principles of strengthening cooperation and trust - partnership relations, as well as on the principle of synergism, that is, the awareness that the effectiveness of managing the whole is always greater than the total effectiveness of its constituent elements. The term "partnership relations" includes a number of types of cooperation style, including cooperation, coordination and joint activity [24].

The characteristics of these relationships are given in table. 1.2.

The main effect of partnership is the use of resources and capacities with the synergistic effect of the interaction of partner organizations, the main goal of which is to build such an integrated structure that is able not only to ensure the competitiveness of enterprises and profit, but also to achieve a stable position on the market in the long-term perspective.

Table 1.2 – Distinctive features of partnership types

№	Types of partnerships	Types of activities	Term	Scale of activity
1	Cooperation	Fewer number of contracts Longer term contracts	Short-term	The only function performed
2	Coordination	Information relations Relationships on work in progress	Long-term	Several functions performed
3	Common activity	Electronic data exchange. Integration of the supply chain Joint planning Joint use of technologies	Long-term, without a fixed date	Companies consider each other as an extension of their own enterprise

In the conditions of globalization, several fundamentally different forms of strategic partnership in the supply chain may be appropriate (Fig. 1.5).

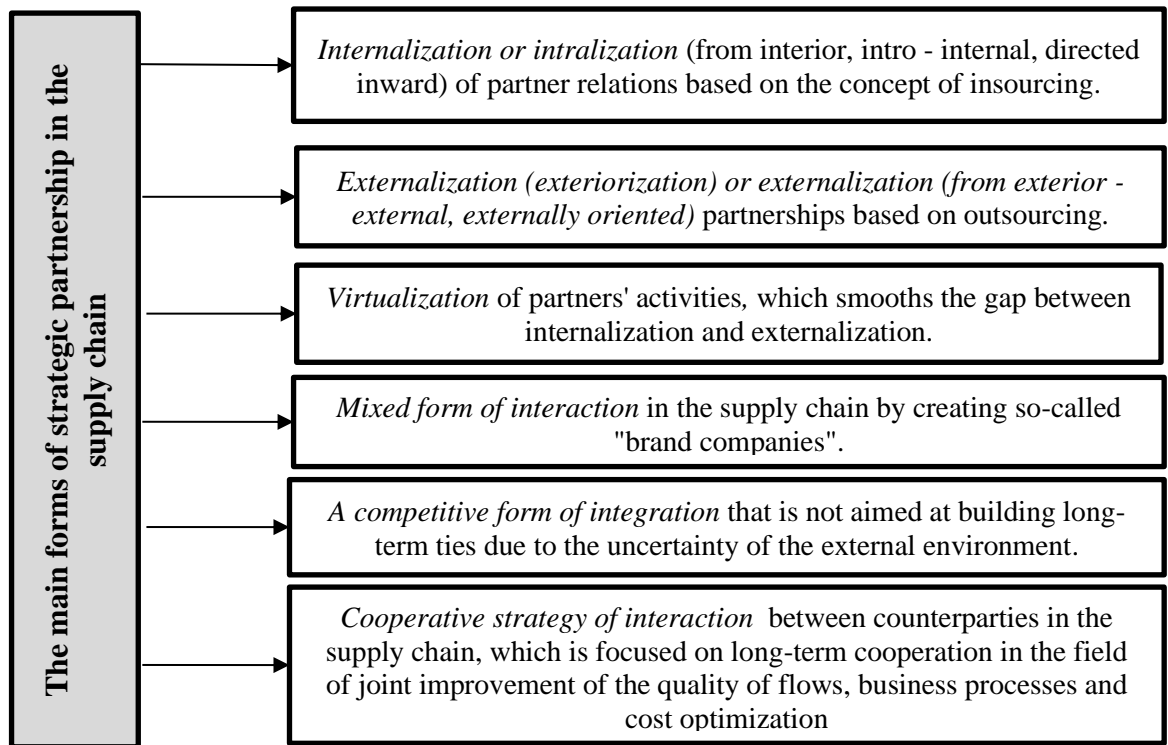

Figure 1.5 - The main forms of strategic partnership in the supply chain

Building a supply chain on the basis of internalization (insourcing) implies the unification of related types and distribution of functions of production activities within one organization. Such integration is typical for enterprises of fuel and energy, construction, agro-industrial complex. Business entities seek to insure themselves against unfavorable market conditions by creating closed, self-sufficient structures.

The main advantages of building supply chains on the basis of internalization are: increased control over the participants of the system; management of intra-company flow processes from a single logistics center mainly on a non-commodity basis; ensuring the stability and reliability of economic relations and supplies. The main disadvantage of integration based on internalization is the creation of large vertically integrated systems, the so-called push type, which can ultimately lead to an increase in inventory in the supply chain, a decrease in the quality of flow processes and service level, as well as an increase in the number of auxiliary workers. Externalization involves the distribution of functions of production activities between different enterprises with the subsequent synchronization of their activities through partnership agreements (outsourcing). To the greatest extent, this way of developing relationships in the supply chain is typical for the automotive industry, where most of the components are produced at outsourcing enterprises. The synergy of externalization results is enhanced by network integration with partners within corporate alliances. This form of strategic integration should be attributed to pull systems, which are weakly structured.

The main factors "for" and "against" the creation of these systems are shown in Table 1.3.

Table 1.3 – Advantages and Disadvantages of Outsourcing Network Integration in the Supply Chain

Advantages of outsourcing	Disadvantages of outsourcing
the opportunity to focus on the key their competences	the possibility of losing control over the post-heads of goods and services
improving the quality of goods and services that are delivered. And cost reduction	possibility commercial disclosure secrets
access to the latest developments and know-how	dependence from the supplier of goods or services.

In connection with the wide development of information technologies, the ways of organizing the business of enterprises through the virtualization of their activities, including procurement procedures, are changing significantly.

A virtual enterprise is a logistics system formed by using an information network within the framework of a logistics agreement. The goal of virtualization is to reduce transaction costs. Accordingly, the capabilities of the software should include a program for finding members of a virtual enterprise and determining the optimal composition.

From this definition follows the clarification of such a concept as "virtual logistics system", which can be presented in the form of an interdependent set of means, methods and controlling influences on simulated business processes and flows of goods (services), information, finances, etc. in order to improve the quality of service to counterparties and optimize costs. Virtual enterprises function on its basis.

The Internet has created many opportunities to improve performance in the supply chain, namely: the flexibility of the logistics system increases; the quality of customer service in the supply chain improves due to information about the order, the availability of the goods at the supplier, delivery terms, etc.; complete and reliable information makes it possible to reduce the need for stocks and labor resources due to the reduction of uncertainty in the work of counterparties. However, the virtual organization also has a number of disadvantages, which include the need for a detailed study of the partner company and the presence of a high level of trust between counterparties, which is not always possible.

Therefore, the generalization of theoretical developments and practical experience allows us to define the supply chain as a sequence of dual relationships between companies that can follow a cooperative, competitive or team relationship strategy. Of course, the specific goals of each participant may differ from the general ones, and possibly oppose the goals of other participants of integrated structures. However, all these specific goals of individual participants must obey the same general principles, which are the main goal of integration. Partnerships in the field of business are a necessary condition for contractual relations between several entrepreneurs, giving each of them the opportunity to obtain a certain level of profit due to the exchange of activity results.

1.3 Information technologies used to support the interaction of supply chain participants

Integrated management of supply chains must be considered both from an organizational and management point of view, as well as from an informational point of view. This means that the construction of an integrated management system begins with organizational changes and the creation of complex information models and technologies for planning and managing supply chains.

Usually, the stage of development and implementation of information technologies is the final stage in the construction of the SCM system. At the same time, its most important component is the creation of a single information space, i.e. environment of integrated planning and management, coordination and communication of all supply chain contractors.

The main goals of information integration of supply chains are shown in Fig. 1.6

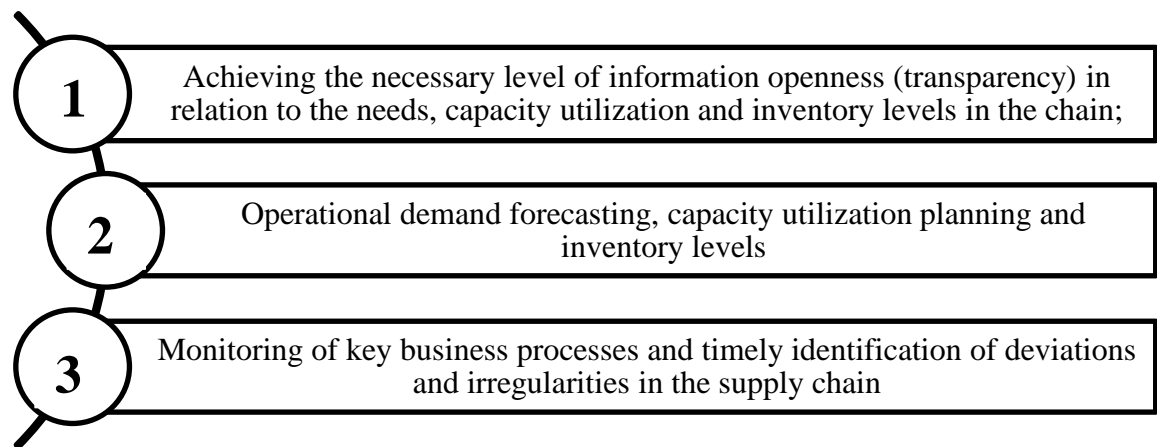

Figure 1.6 - The main goals of information integration of supply chains

The effectiveness of solutions in supply chains is largely determined by the information infrastructure that supports the execution of business processes in the chain. Due to the high complexity of process integration in supply chains, tasks arise that cannot be implemented with the help of information systems of the same class.

Each business process in the supply chain is performed by different contractors and is often supported by several information systems. This information infrastructure was called the unified information space of supply chain contractors.

The unified information space (UEI) of supply chain contractors is a set of heterogeneous (heterogeneous) information systems of different economic functionality, integrated with each other for the purpose of constant information exchange and intended to create a unified environment for the coordination of actions and interaction of supply chain participants in the implementation of their main management functions (planning and operational management) in real time.

Considering the complexity and complexity of modern logistics and production systems, the effectiveness of integrated management is directly determined by the use of appropriate information technologies for automated processing, accounting and storage of information, as well as for supporting decision-making processes.

The main elements of a unified information space are shown in Fig. 1.7

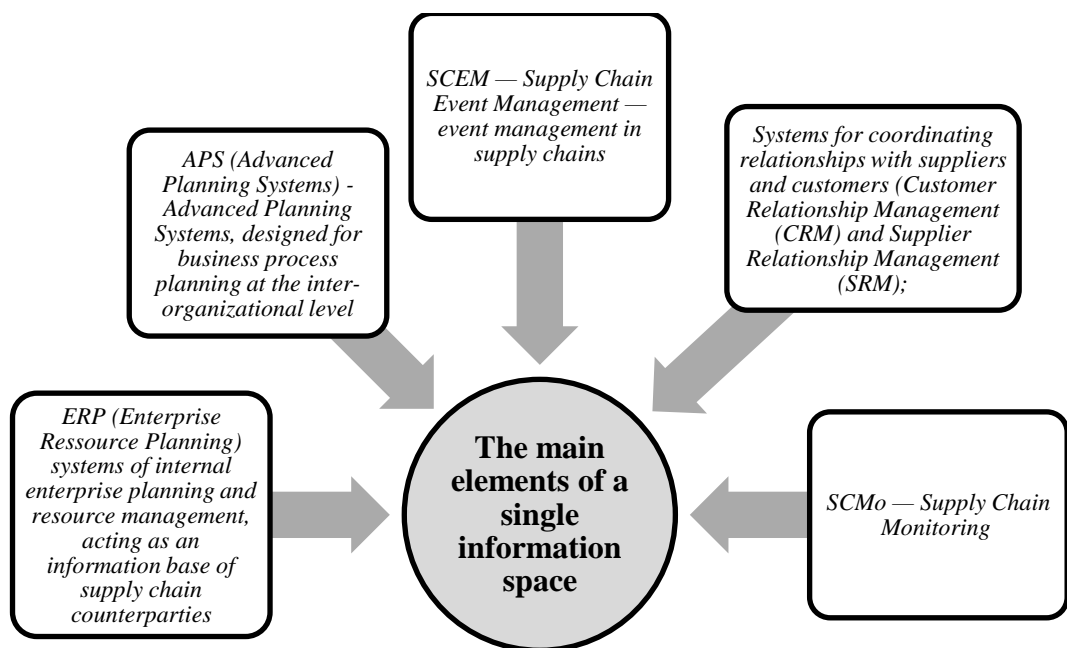

Figure 1.7 - The main elements of a unified information space

These information systems act as a functional and technical infrastructure that ensures the integration of counterparties in the SCM concept. The tasks of this infrastructure include strategic configuration of the supply chain {Supply Chain

Configuration), tactical and operational planning {Supply Chain Planning) and operational management {Supply Chain Execution).

To solve planning problems in supply chains, a special type of information system was developed - APS - advanced planning system. "Advanced planning" in this context can be interpreted as a new logic of planning, with the help of which it is possible to overcome the shortcomings of traditional systems of planning and management of a production enterprise.

The planning methodology, which is included in APS-systems, is fundamentally different from the concept of MRP-class systems. The main functionality of MRP systems lies in the area of decision support. Mathematical algorithms that meet high requirements for operational planning are included in APS systems. These systems allow planning of relatively limited capacities taking into account "bottlenecks", as well as simultaneous verification of compliance of capacity availability with requirements and restrictions when drawing up a production plan. At the same time, the APS system planning methodology incorporates the principle of interactivity: the manager of the planning department receives the planning results with the indication of bottlenecks (for example, a part, the later production date of which causes a deviation of the possible delivery date of the finished product from the date desired by the client). On the basis of detailed information, the manager can perform appropriate management actions (for example, schedule an additional shift of workers on the desired date or agree with the supplier on urgent delivery or change the volumes of the planned delivery). In contrast to the concept of MRP II, in A RS'-systems, in the case of operational changes, existing plans are corrected, and not completely new replanning.

APS systems were initially intended to solve problems of intra-company planning, soon they began to be successfully used for dynamic and complex supply chains. As the concept of SCM developed, the demand for APS class systems increased sharply.

SCEM systems (event management in supply chains) are intended to identify such violations and deviations in the performance of work, such as delay or breakdown of a vehicle, exceeding the level of insurance stock, deviations in production processes, etc.

In the event of a deviation, the SCEM system identifies the affected parts of the supply chain and notifies the person making the decision about the causes and consequences of the violation. The main functions of SCEM systems are monitoring (recognition and visualization of disruptions and interference), alert management (Alert Management) and simulation modeling of alternative options for further execution of supply chain processes. For the effective functioning of SCEM systems, it is necessary to create an EIP from the information systems of all contractors, which ensures the necessary degree of relevance and accuracy of data.

In recent years, a number of large companies have effectively implemented SCMo systems — monitoring of supply chains, which are intended exclusively for visualization of the real flow of processes in supply chains, mainly in the field of inventory level control and the use of production and logistics facilities.

The integral manager of the supply chain in the focal company receives a comprehensive view of the current situation in the chain and has the opportunity to compile various analytical reports regarding the behavior of supply chain counterparties. Participants of the second links of the chain have similar information directly on their suppliers and customers. Information is entered into the system by suppliers/contractors themselves, for example, using the Internet. SCMo systems are not powerful optimization systems, but their effectiveness is confirmed in practice. First of all, this is related to the psychological aspect of the emerging transparency of the system, which increases the level of responsibility of suppliers.

Proceeding from the above, the creation of a complex information network of the EIP with the participation of supply chain contractors - suppliers, product manufacturers, trading companies and clients is an extremely complex organizational and technical process and requires careful preliminary preparation in the form of a clear description of inter-organizational coordination, documentation of business processes, models of integrated planning and supply chain management. Only in the presence of clearly formulated and documented rules and processes of the interaction of counterparties, it is possible to begin the development of the EIP concept.

As already indicated, in order to build an integrated informational SCM support, in addition to the ERP and APS systems, the EIP includes the following systems (Fig. 1.8):

- Customer Relationship Management (CRM);
- Supplier Relationship Management (SRM);
- Supply Chain Event Management (SCEM);
- E-Supply Chain Management (e-SCM).

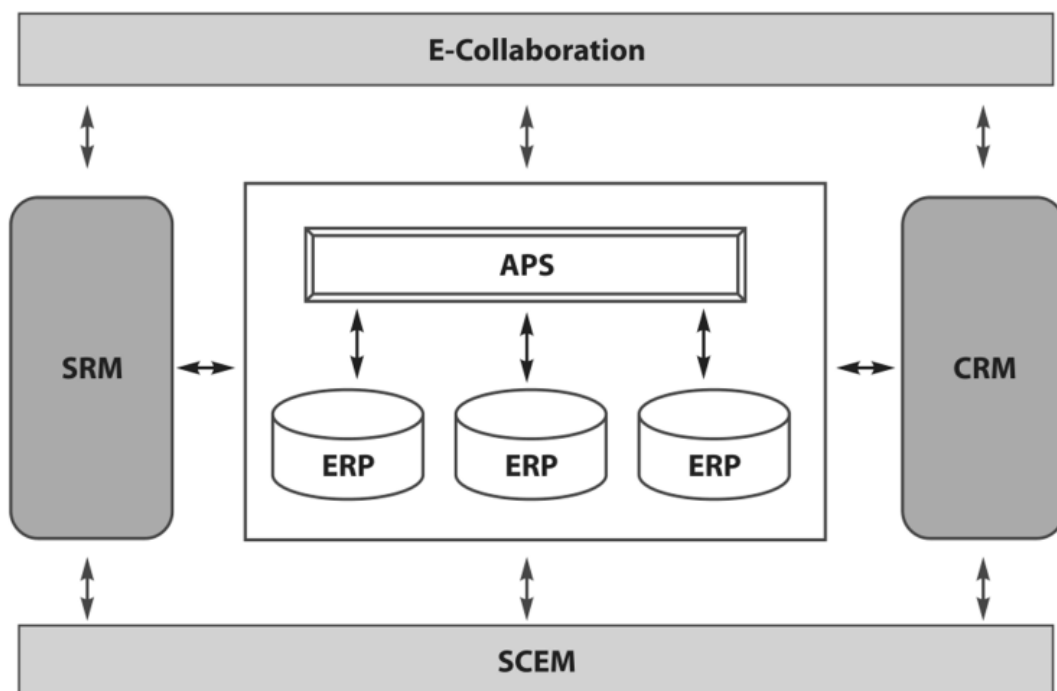

Figure 1.8 - The structure of the information interaction for supply chain management

Let's consider the main components in more detail.

CRM applications (Customer Relationship Management) have become necessary in a highly competitive market where the customer is the focus. The main task of CRM systems is to increase the efficiency of business processes concentrated in the "front office" of the company, aimed at attracting and retaining clients - in marketing, sales, service, regardless of the channel through which contact with the client occurs.

The integrated CRM system provides coordination of the actions of the company's divisions, providing them with a common platform for interaction with clients. From the point of view of cross-functional coordination, the appointment of CRM will correct the situation when marketing, sales and service departments operate independently of each other, and their understanding of the customer is often different, and their actions are not coordinated. From the standpoint of business process management, the integral effect of CRM implementation is manifested in the fact that the decision-making process due to automation is transferred to a lower level and unified. Due to this, the speed of response to requests increases, the speed of capital turnover and costs are reduced. The functionality of CRM applications covers marketing, sales and service, which correspond to the stages of customer acquisition, the very act of making the transaction (transaction) and after-sales service, i.e. all the points of contact where the supply chain counterparty interacts with the client.

SRM systems — supplier relationship management — are used to support supplier interaction functions. The main functions of SRM systems are strategic selection of suppliers, joint development of new types of products, implementation of the entire procurement cycle, operational monitoring and evaluation of supplier activities.

The information support of CRM, SRM, and such concepts/technologies as VMI and CPFR forms a modern integrated environment — EIP of supply chain contractors.

Further development of integrated IT applications for SCM is connected with Internet technologies. On their basis, the concept of business-to-business (B2B) was developed, which became a kind of "bridge" connecting SCM and the Internet. It is on the basis of the combination of E-Business concepts and classic SCM systems that a new E-SCM concept emerged, the basis of which is the virtual enterprise model. In the E-SCM concept, the Internet acts as a communication medium for partners in supply chains and their information systems. The main elements of E-SCM include E-Procurement, E-Fulfillment, E-Commerce, E-Collaboration.

So, the information systems we considered determine the basis for effective cross-functional and inter-subject information interaction in supply chains.

Based on the above, we will formulate the main methodical principles of the formation of information interaction between participants in supply chains, which are depicted in Fig. 1.9.

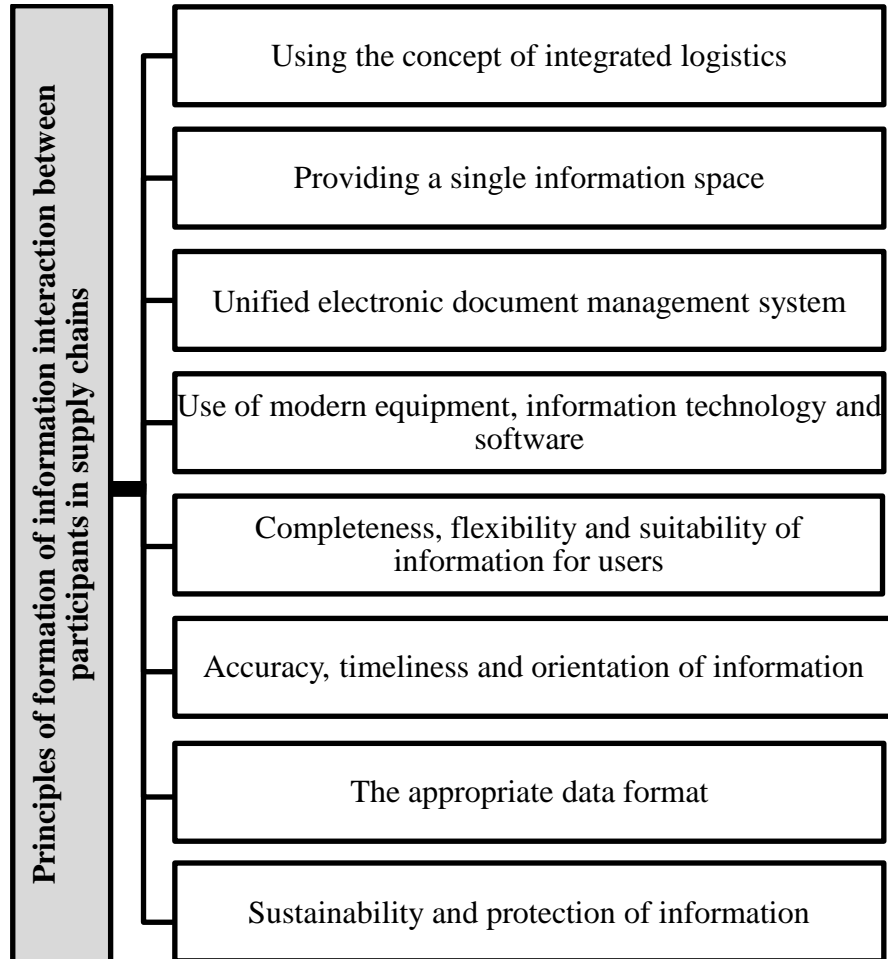

Figure 1.9- Principles of formation of information interaction between participants in supply chains

Let's consider them in more detail:

1. Using the concept of integrated logistics The essence of the concept of integrated logistics is to consider logistics as a kind of management tool, integrated material flow to achieve the goals of micro- or macro-LS. This concept reflects the modern paradigm of CP management (supply chain), where individual firms, organizations, systems that form the CP are considered as some centers of logistics activities, directly or indirectly connected in a single integrated process of managing material and information flows for the most complete and high-quality customer

satisfaction. The use of the concepts of integrated logistics in the design of the CP monitoring system of the business organization allows to combine the efforts of the management staff of the central company, its structural units, suppliers, consumers and logistics partners in the end-to-end tracking of information flows of the integrated business structure of the CP to optimize overall costs.

2. Provision of a single information space. It is necessary to provide a single information space for all participants of the CP: suppliers, manufacturers, logistics intermediaries and buyers. This space should be based on corporate or global telecommunication networks (for example, the Internet) and provide the possibility of information exchange between CPU links and obtaining reliable information about the progress of the logistics process.

3. Monitoring in real time. Modern information technologies opened the era of real-time competition, created an opportunity to increase the efficiency and accuracy of logistics operations and functions in the central processing unit. Logistics managers can now receive more accurate and operational information about sales, which means that they can make adequate decisions on the management of logistics functions. More timely and complete information gives the advantage that the traditional dependence when making logistics decisions on forecasts is reduced (in fact, they become much more accurate), as well as the need to maintain significant insurance reserves in the CPU. Real-time CPU monitoring allows you to speed up logistics operations,

4. Unified system of electronic document circulation. In order to increase the efficiency of the monitoring system, a single document flow system must be provided for all participants of the Central Processing Unit, corresponding to EDI standards - electronic document flow.

5. Use of modern equipment, information technologies and software. Modern approaches to the use of graphics, relational databases, CASE technologies for their development, the architecture of client-server type computing systems and their implementation as open systems, CALS technologies in terms of information monitoring of the product life cycle should be used during the construction of the CPU. as well as modern computer, telecommunication equipment and software.

6. Completeness, flexibility and suitability of information for users. The logistic system of CPU monitoring should provide users with the necessary, complete and reliable information for decision-making. For example, information about the status of inventory or customer orders often requires pre-processing and is usually not located where the logistics manager makes decisions. Therefore, the monitoring system should provide information in the place, of the type and completeness that is needed. performance of relevant logistics functions and operations in the central processing unit. The information circulating in the CPU should be adapted for specific users and have the most convenient form for them. This applies both to the personnel of the company - the "master" of the logistics process, and to the three parties in the LS. Paper and electronic document flow, intermediate and output forms, reports,

7. Accuracy, timeliness and orientation. The accuracy of the source information is of fundamental importance for making the right decisions when managing the CPU. For example, information about the level of stocks in the distribution network in modern pharmaceutical companies allows no more than 1% of errors or uncertainties for making effective decisions in physical distribution, stock creation and customer satisfaction. The accuracy and reliability of the initial data is of great importance for forecasting demand, planning product needs, etc. Reliable information must be delivered to the CPU control system on time, as required by logistics technologies, especially based on the JIT concept. The timeliness of information is important practically for making most logistical decisions. In addition, many tasks of transportation, cargo handling, management of orders and stocks in the CPU is now solved in the "online" mode. The requirement of timeliness of receiving and processing information is implemented by modern logistics technologies of scanning, satellite navigation, bar coding, implementation of EDI/EDIFACT standards.

8. Appropriate data format. Data and message formats used in computer and telecommunication networks of the CPU system must use the performance of telecommunication equipment and computer equipment (memory capacity, speed, bandwidth, etc.) as efficiently as possible. Types and forms of documents, location of details on paper documents, dimensions of data and other parameters should facilitate

machine processing of information. In addition, information compatibility of computer and telecommunication systems of counterparties and other users in terms of data formats in the CPU system is required.

9. Stability and protection of information. The logistics system of CPU monitoring should work stably with permissible deviations of technical parameters, as well as possess a given level of immunity. The system must provide available means of information protection against distortion and unauthorized access. The principles of formation, storage and transfer of information to its users in the management of the CPU should ensure the delivery of the required information in the required amount, to the required place and at the required time.

Thus, the creation of EIP, i.e. the environment of integrated planning and management of the entire supply chain, as well as coordination and communication of its counterparties is the most important component of the SCM concept. It is the quality of information support that largely determines the success and effectiveness of SCM-resolved. IT plays the role of a catalyst that enables a fundamentally new level of cooperative relations, business process reengineering, and the development of integrated planning and supply chain management models.

1.4 Chapter 1 summary

It was determined that supply chain management is a systematic approach to planning and managing the flow of information, materials and services at all stages of the movement of goods from the manufacturer to the end consumer. The basis of the modern development of supply chain management is increasing the value of information. The use of information in supply chains is aimed at ensuring a quick and correct exchange of information between partners about real and forecasted demand from customers, about changes in stocks, about transport and storage capacities.

Effective process of managing such a logistics system should be based on the collection of information about the managed object, its analysis, preparation and adoption of management decisions, as well as control and organization of the implementation of these decisions. This requires high-quality information support of the enterprise, which should display relevant information about the object of management for the implementation of complex logistics activities.

It is characterized that the efficiency of the supply chain has a direct relationship with the information support of the enterprise and the automation of the information logistics system. The most widespread modern complex software systems in the world are systems of: enterprise resource planning class (Enterprise Resource Planning - ERP), which provide management of all enterprise processes; class of enterprise relationship management (Supply Chain Management - SCM), which provides management of logistics chains.

Integrated supply chain management must be considered both in the organizational and managerial, and in the informational aspect. This means that building an integrated management system begins with organizational changes and the creation of complex information models and technologies for planning and managing supply chains. And only after the synchronization of all the main business processes, the development of a strategy and conceptual SCM models, it is possible to start work on the implementation of information systems that support integrated supply chain management.

CHAPTER 2

ANALYSIS OF INFORMATIONAL INTERACTION OF LLC “DSV LOGISTICS” COMPANY IN SUPPLY CHAIN

2.1 General characteristics of the company

DSV is a Danish transport and logistics company offering transport services globally by road, air, sea and train. Since its foundation in 1976 by nine independent Danish hauliers, the company has achieved rapid expansion and international presence, predominantly through a series of strategic competitor acquisitions, some of the most important ones being Samson Transport (1997), DFDS Dan Transport Group (2000) , JHBachmann (2004), Frans Maas (2006), ABX LOGISTICS (2008) and UTi Worldwide, Inc. in 2016. In April 2019, DSV signed an agreement to acquire Panalpina Welttransport (Holding) AG and the deal was closed in August 2019.

Almost half a century of transport expertise and since our establishment in 1976, we have been through a series of mergers to maintain a key position in the global transport industry. As a result, we are now one of the largest transport and logistics companies in the world.

Today, DSV – Global Transport and Logistics is 1500 offices and logistic facilities provide and manage supply chain solutions for thousands of companies every moment, from the small family run business to the large global corporation. DSV reach is global, yet logistic company presence is local and close to company customers. 75000+ employees in more than 80+ countries worldwide work passionately to deliver great customer experience and high-quality services – and help ensure a steady supply of goods to production lines, outlets, stores and consumers all over the world. DSV believes world trade drives world prosperity, but seamless trade is not a given.

Table 2.1 presents the main milestones in the formation of a logistics company.

Table 2.1 – The main milestones in the formation of DSV [64]

Milestones	The event of milestones
1976	DSV, De Sammensluttede Vognmænd af 13-7 1976 A/S, is founded by nine independent Danish trucking companies and business developer Leif Tullberg.
1987	DSV is listed on the Copenhagen Stock Exchange, Denmark.
1997	DSV acquires Samson Transport Co. A/S, thereby tripling the transport and logistics activities of the Group.
2000	DSV acquires DFDS Dan Transport Group A/S. The transport and logistics activities of DSV are quadrupled.
2002	DSV enters into a 50/50 joint venture with TNT regarding DFDS Transport Logistics A/S.
2003	DSV, De Sammensluttede Vognmænd af 13-7 1976 A/S changes its name to DSV A/S.
2004	DSV divests DSV Miljø A/S (Environment Division) to focus more on the transport and logistics parts of the DSV Group. DSV buys back the remaining 50% of the Logistics Division from TNT.
2005	DSV acquires JH Bachmann GmbH to strengthen the Air & Sea Division.
2006	DSV acquires Koninklijke Frans Maas Groep NV, thereby becoming the third largest transport company with its own Road activities in all of Europe
2007	DFDS Transport changes its name to DSV.
2008	DSV acquires ABX LOGISTICS and strengthens its global network. DSV acquires Roadferry Ltd., UK. DSV divests its 50% stake in Tollpost Globe AS, Norway
2009	DSV and LOS INKAS Group of Companies enter into a joint venture under the name DSV-GL to strengthen their network in Latin America. Jens Bjørn Andersen is appointed CEO and the previous CEO Kurt K. Larsen takes over as Chairman of the Board of Directors.
2012	DSV acquires Swift Freight Group of Companies that have 36 offices spread across 15 countries in Africa, the Middle East and Asia. DSV expands its footprint in Latin America by establishing its own offices in Brazil and acquiring the remaining 60% of the shares in DSV-GL Latin America SA from its joint venture partner.
2013	Acquisitions are still an important part of DSV's growth strategy. Seatiners Group A/S based in Denmark, SBS Worldwide Holdings Ltd from the UK, Airmar Cargo in Colombia and the Scandinavian based Otime Logistics AS have been added to the DSV network.
2016	DSV acquires UTi Worldwide Inc., a global supply chain services and logistics company, strengthening the company's presence in the US and Africa.
2019	DSV joins forces with Panalpina Weltransport, a global provider of transport and logistics services, becoming the world's fourth largest freight forwarding company.
2021	DSV acquires Agility's Global Integrated Logistics business (GIL), a leading global transport and logistics provider with a strong footprint in emerging markets and with a broad span of strong offerings within logistics. With this addition to the organization, DSV becomes a global top-three player within transport and logistics.

So, we can state that from the beginning, the story of DSV has been a story of entrepreneurs with great business acumen and the courage to embark on a journey of continued growth.

The mission statement of DSV is to provide a business and environment for all employees to feel part of and be proud of, which encourages and supports everyone to do a first class job, the first time and every time.

DSV 5 strategic aims which will ensure logistic company deliver customer excellence are:

- 1) Provide a competitive, cost effective and diverse range of services.
- 2) Ensure total quality in everything we do.
- 3) Demonstrate reliability in everything we deliver.
- 4) Remain flexible but focused on meeting and exceeding our customer needs.
- 5) All our services need to be as fast as possible but without compromising customer expectations.

The DSV logistic company vision is “Sustainable growth. We strive to help our customers, employees, shareholders and the societies in which we operate to grow. This way we create sustainable growth for DSV”, because in 2021, the company defined their corporate purpose: Keeping supply chains flowing in a world of change. LC are proud to be part of the critical infrastructure that enables their customers, employees, shareholders and societies at large to grow and prosper.

According to the vision of the LC, strategic focus consists of four areas, moreover, sustainable growth is at the center (fig. 2.1).



Figure 2.1 – Four strategic focus areas of DSV [65]

Consider these areas in more detail:

- 1) DSV helps our customers grow by keeping their supply chains flowing. LC creates efficient solutions for all businesses with a focus on reliability, environmental impact and cost – regardless of industry and size.

2) DSV provides equal growth opportunities for all employees. People drive the success of our company, so the more we provide healthy and safe workplaces – as well as strong growth opportunities – the greater is our chance of achieving our ambitious growth targets.

3) DSV helps societies grow. LC conducts our business with integrity, respecting different cultures and the dignity and rights of individuals in all countries.

4) DSV grows shareholder value. LC wants to continue to be a leading global supplier, fulfilling the customer needs for transport and logistics services. LC targets extensive growth - organic and through acquisitions - and aims to be among the most profitable in our industry.

DSV is among the top five global freight forwarders with an estimated 4% market share (fig. 2.2). Together, the top 5 players have a market share of approximately 20% of the global freight forwarding market, and the top 6-20 players approximately 20% of the market. Because the freight forwarding market is fragmented it is highly competitive, making price one of the main competitive factors. In recent years, several of the large freight forwarding players have systematically gained market share.

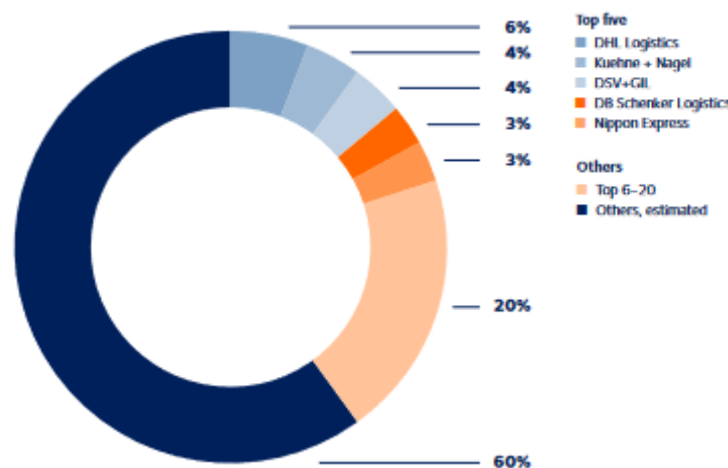

Figure 2.2 - Market share of the top five global freight forwarders [66]

DSV A/S is listed on NASDAQ Copenhagen (Denmark) and included in the C25 index as one of the 25 most actively traded shares on the Copenhagen stock exchange.

DSV A/S is the parent company, and our organization is divided into three divisions: DSV Air & Sea, DSV Road and DSV Solutions (see fig. 2.3).



Figure 2.3 – Business structures of DSV [67]

DSV Road is one of the leading road freight operators in Europe with distribution networks in North America and Africa. Annually, LC handles more than 30 million shipments and every day more than 20,000 trucks are ready to carry your goods in a fast, efficient, flexible and environmentally friendly manner.

DSV Air & Sea offers alternative routings and flexible schedules to suit even the most demanding logistical requirements to and from all parts of the world. LC handles more than 2,600,000 TEUs of sea freight and 1,700,000 metric tons of air freight every year.

At DSV Solutions LC partner with our customers to design and deliver logistics solutions, adding value by increasing operation and cost efficiency. LC operates hundreds of logistics facilities comprising a total of 6,000,000 m².

DSV Lead Logistics uses cutting edge technology to provide enhanced, transformative, flexible and resilient logistics solutions that create cost and service advantages for our customers. LC combines intelligent supply chain solutions with skilled staff to predict and react to real world events and opportunities as they happen.

Priority areas of innovation of the DSV company can be seen in the figure. 2.4.



Figure 2.4 – Focus areas of DSV [68]

Existing competitors of the DSV logistics company count over 20 large Ukrainian companies, which provide services for road transportation of mail and small cargo (for example, the national operator PJSC Ukrposhta, LLC Nova Poshta, the national postal and logistics operator LLP "Mist Express" , LLC "Delivery", LLC "Vladtrans"), a number of small domestic companies and transnational carriers such as DHL, UPS, TNT Express, SkyNet Worldwide Express, FedEx, 4PX, China Post. There are only about 12,000 courier delivery companies in Ukraine. PJSC "Ukrposhta", LLC "Avtolyuks" (1988), "Günsel" (1988) are considered "old-timers" of the segment. In the field of air transportation, there are Supenova airlines, Nova Poshta Global, Post international, Meest, DSV, DHLexpress, FedEX, TNTexpress,

Starting from 1997, private express delivery companies began to appear. In 2021, the leaders among commercial operators were: "Nova Poshta", "Mist Express", "Justin", "Delivery".

In Ukraine DSV is represented as follows:

1. DSV is one of the leading transport and logistic service providers in Ukraine,
2. DSV in Ukraine offers road, sea and air freight, special project transportations, logistics, warehousing and customs clearance.

The logistics company has branches in 5 cities of Ukraine, which are presented in figure 2.5 , among them the HQ with warehouse are located in Kyiv and branch office in Boryspil, which is engaged Air & Sea freight [74].

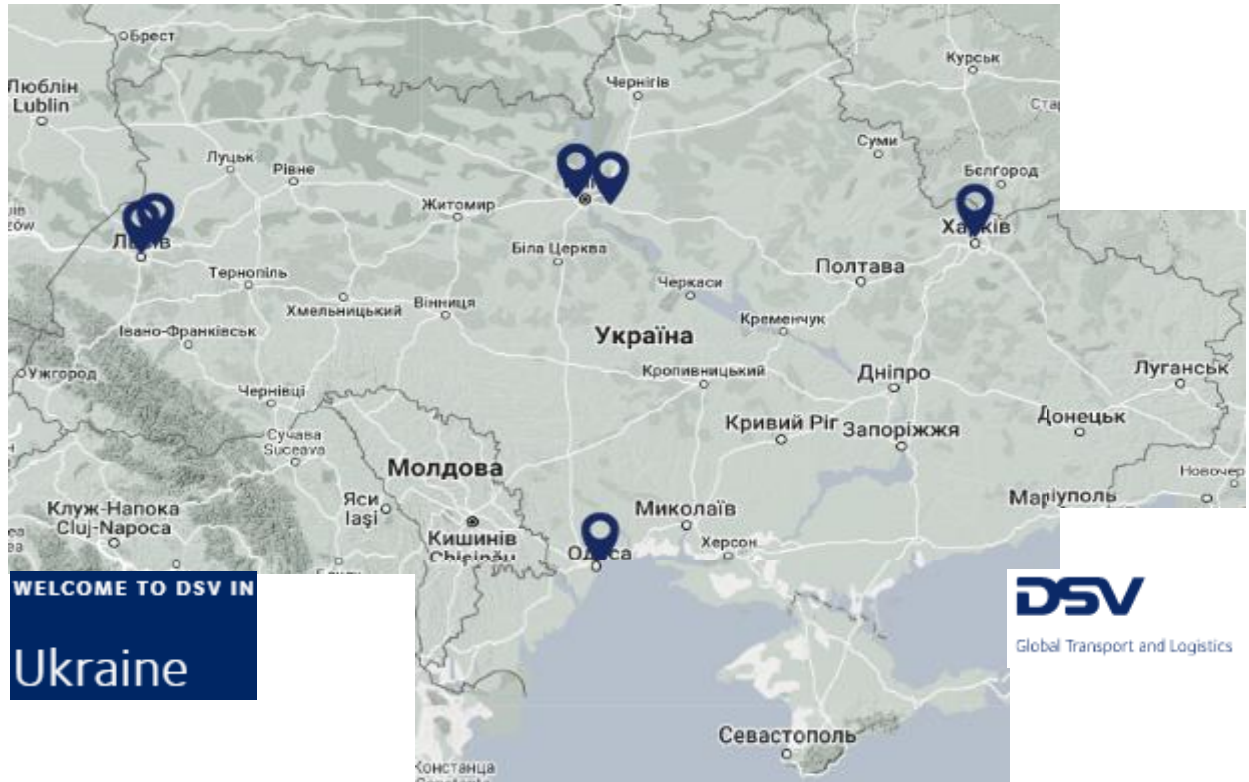

Figure 2.5 – Branches of DSV logistics company in Ukraine [69]

In the analytical online system YouControl, which forms a complete dossier for each company and individual entrepreneur of Ukraine based on open data from more than 180 sources, monitors changes and visualizes connections, it is possible to find out that DSV operates in Ukraine under the name "DSV LOGISTICS" LLC, where the founder of the legal entity is DSV [73].

So, DSV is one of the world's leading freight forwarders that helps companies connect with the world and ensure smooth and efficient storage and transport of their goods by road, sea and air. Company keeps supply chains flowing – from shipper to customer doorstep – and helps to deliver sustainable growth by giving their customers the logistics services they require. Combining the latest technologies and the talent of its strong global workforce, they make supply chains leaner and greener.

2.2 Analysis of the financial indicators of the logistics company

The great impact on the financial indicators had the acquisition with GIL. The acquisition of GIL was completed on August 16, 2021. From that date, DSV included GIL in the company's consolidated financial statements, and it had a material impact on the profit and loss statement, cash flow and balance sheet statements. Between 16 August and 31 December 2021, GIL contributed around DKK 15,000 million to revenue and DKK 950 million to EBIT before special items for the Group.

The GIL business was a leading global transport and logistics provider with a strong footprint in emerging markets. The business offered a mix of integrated logistics services, including air, ocean and road freight forwarding services, contract logistics and specialized logistics capabilities. GIL operated a flexible, customer-centric and sustainability-driven business with a global workforce of approximately 17,000 employees and service provision across 100+ countries around the world (incl. agents). GIL empowers businesses of all sizes, from small businesses to large multinationals, through sector-specific expertise and digital tools and technology to enhance supply chain efficiency. The main financial and operating indicators that describe company's performance after acquisition with GIL are shown in fig.2.6.

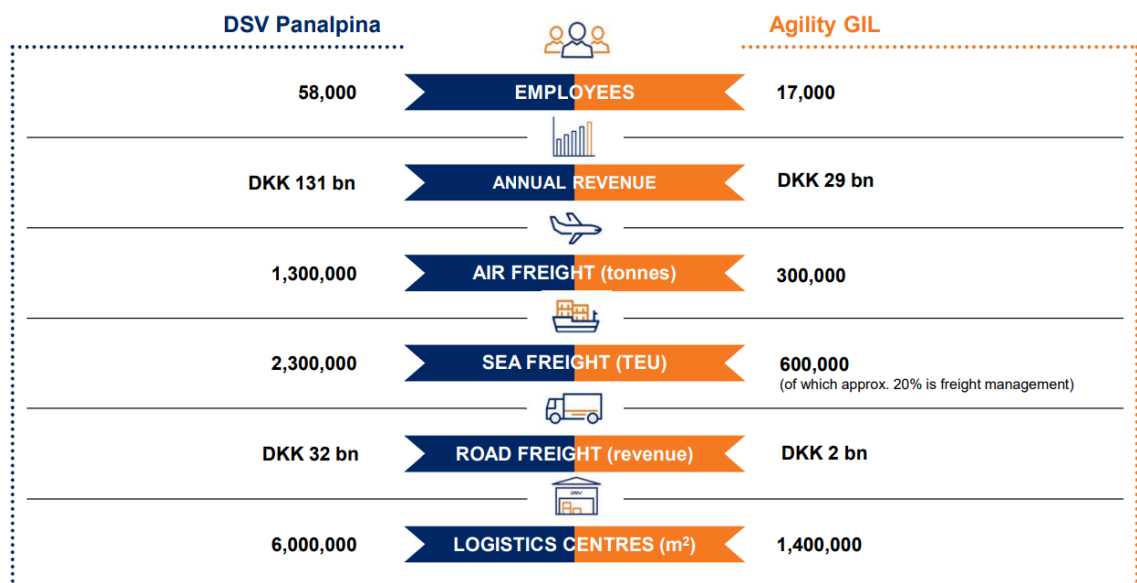

Figure 2.6 – Operating performance of DSV after acquisition with GIL [70]

In table 2.2 are shown the dynamics of basic financial results of DSV + GIL.

Table 2.2 – Dynamics of the main financial indicators of DSV +GIL [71]

(DKKm)	FY 2018	FY 2019	FY 2020	FY 2021	YTD 2022
Revenue	79,053	64,579	115,932	182,306	184,434
Direct costs	61,564	47,909	87,938	144,691	143,941
Gross profit	17,489	16,670	28,534	37,615	40,493
Other external expenses	3,036	-	3,291	4,173	4,058
Staff costs	8,241	9,239	11,684	13,025	12,284
EBITDA	6,212	7,431	13,559	20,417	24,151
Amortization and depreciation	0,762	2,561	1,049	1,050	0.950
EBIT	5,450	4,870	9,520	16,223	20,455
Special Items, net costs	-	0,191	2,164	0.478	1,117
Financial costs, net costs	0,249	0,435	1,729	0.841	0.951
Profit before tax	5,201	4,244	5,627	14,904	18,387
Profit for the period	1, 213	0,983	4,258	11,254	13,882

Schematically, the dynamics of the main financial indicators of the company are presented in Figure 2.7.

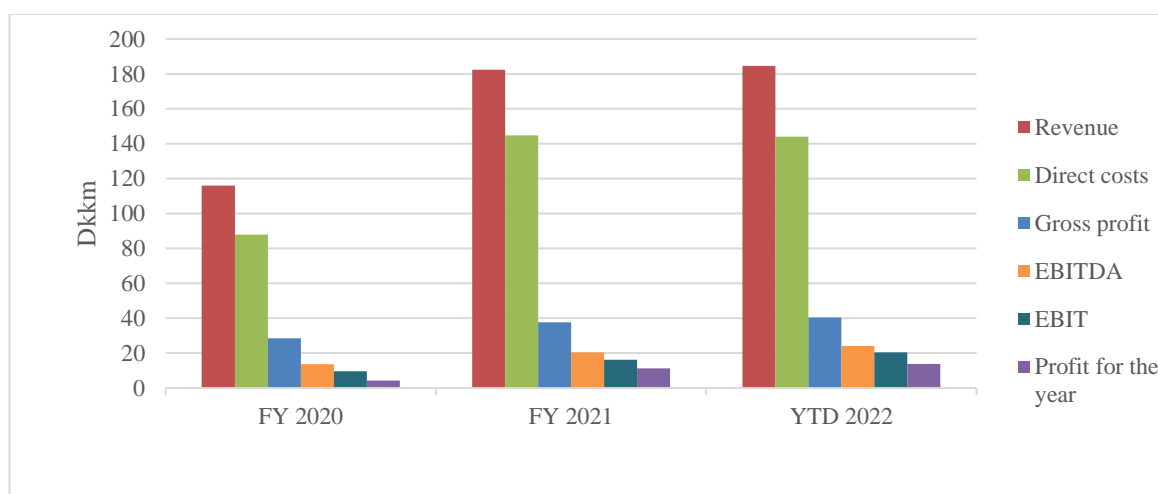

Figure 2.7 – The dynamics of the main financial indicators of the logistics company DSV

Consider in more detail the main financial result of the company by business units. Revenue by each division is shown in table 2.3.

Table 2.3 - Revenue by business division of logistics company

(DKKm)	2020	2021	Growth
Air & Sea	73,689	131,901	81.6%
Road	30,395	35,416	16.2%
Solutions	14,608	18,734	28.4%
Group and eliminations	(2,760)	(3,745)	-
Total revenue	115,932	182,306	58.6%

Base on the data above we can conclude that Air & Sea division grew revenue by 81.6%. Apart from the impact of acquisitions, the increase was driven by record-high rates for both air and sea freight and organic growth. Compared to 2020, Road and Solutions divisions also grew revenue. This was driven by volume recovery after the pandemic in 2020, market share gains and the impact of acquisitions.

To analyze the first subtotal from the table 2.2 – gross profit, it is necessary to conduct geographic segmentation of this indicator and by divisions (see fig.2.8).

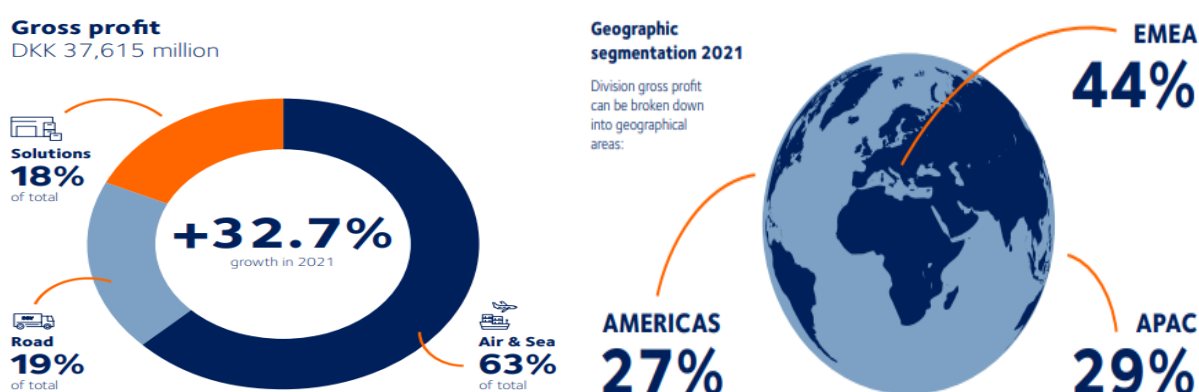

Figure 2.8 – Geographic segmentation of gross profit and by divisions in 2021

Gross profit totaled DKK 37,615 million for 2021 (2020: DKK 28,534 million) corresponding to an increase of 32.7%. The growth was mainly driven by volume growth and higher gross profit yields, partly due to extraordinary market conditions. Gross profit increases in Road and Solutions were mainly driven by growth in activity compared to 2020.

The Air & Sea division achieved growth in gross profit of 42.3%, Road achieved 15.1% and Solutions 23.9%. Gross profit and growth by division compared to the same period last year are specified below: Air & Sea by 59.1%, Road by 15.3%, Solutions by 51.4%.

The growth in Air & Sea was driven by the addition of GIL and higher gross profit yields for both air and sea freight. Yields continue to be impacted by the extraordinary market conditions on the global freight markets. In Road and Solutions, the growth in gross profit was mainly driven by higher activity and the addition of GIL compared to 2021.

Regionally, the highest growth rates were achieved in the EMEA region with 58% and in the AMERICAS with 22% (see fig. 2.8). In APAC, growth to gross profit was 20%. Gross profit - primarily in Air & Sea - was positively impacted by a 42.3% or DKK 23,769 million in 2021 than DKK 16,909 million in 2020.

Next subtotal – operating profit or EBIT rose 71.3%, driven by strong gross profit growth, continued focus on cost management and the positive impact of the GIL integration. With an increase of 83.5%, Air & Sea division grew the most in 2021 (see table 2.4), driven both by underlying improvements and by the extraordinary market conditions in the sector

Table 2.4 - EBIT by business division of logistics company

(DKKm)	2020	2021	Growth
Air & Sea	7,026	12,768	83.5%
Road	1,390	1,857	32.6%
Solutions	1,161	1,775	51.3%
Group and eliminations	(57)	(177)	-
Total EBIT before special items	9,520	16,223	71.3%

The Air & Sea division reported EBIT before special items of DKK 12,768 million (2020: DKK 7,026 million), up 83.5%. The Road division reported EBIT before special items of DKK 1,857 million (2020: DKK 1,390 million), up 32.6%. The

Solutions division reported EBIT before special items of DKK 1,775 million (2020: DKK 1,161 million), up 51.3%.

The increase in EBIT was driven by the strong growth in gross profit in all divisions and across all geographical regions. Furthermore, the addition of GIL and achievement of integration synergies contributed to the growth. Regionally, the EMEA recorded EBIT growth of 47%, APAC grew 28% and AMERICAS 22% (constant currencies).

Profit for the year totaled DKK 11,254 million for 2021 against DKK 4,258 million for 2020. The growth was driven by higher operating profit, lower net financial expenses – and the absence of integration costs (special items) in 2021.

After analyzing the whole company, let's move to the analysis of each division separately.

The Air & Sea division operates a global network specializing in transportation of cargo by air and sea. The division offers both conventional freight forwarding services and tailored project cargo solutions. The division achieved a 59.1% increase in gross profit and 80.5% increase in EBIT before special items for the first nine months of 2022. The increase in earnings was driven by the inclusion of GIL, strong gross profit yields in challenging freight markets and a strong focus on operational excellence.

The main financial and operations indicators of Air & Sea division DSV are shown in table 2.5.

Table 2.5 – The main indicators of Air & Sea division DSV

(DKKm)	FY 2020	FY 2021	YTD 2022
Revenue	73,689	131,901	138,508
Direct costs	56,780	108,132	111,161
Gross profit	16,909	23,769	27,347
Other external expenses	2,870	3,366	3,201
Staff costs	6,048	6,598	6,391
EBITDA	7,991	13,805	17,755
Amortization and depreciation	0.286	0.329	0.260
EBIT	7,026	12,768	16,842

DSV Air & Sea revenue was DKK 131,901 million in 2021 (2020: DKK 73,689 million). This is an annual growth of 81.6%. The revenue growth was mainly due to record-high freight rates combined with volume growth – especially in air freight. The growth was driven by all regions and, from August 2021, was boosted by the GIL acquisition.

Schematically, the dynamics of the main financial indicators of the Air & Sea division are presented in Figure 2.9.

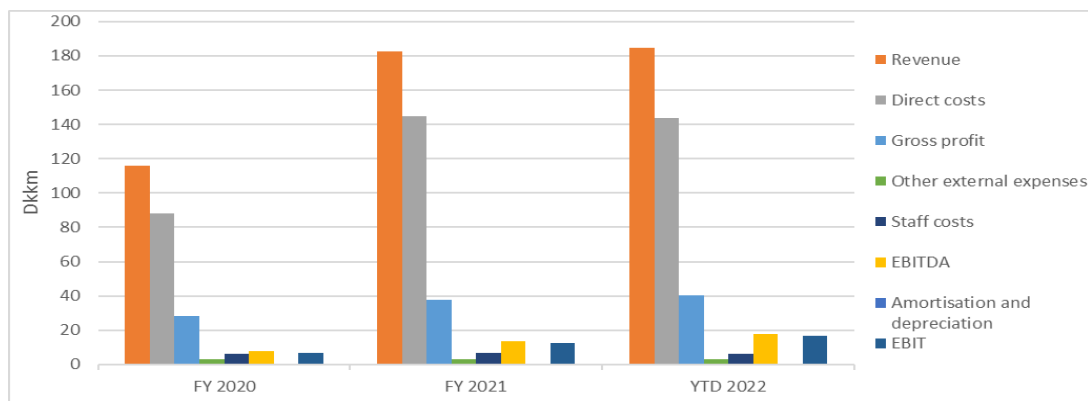

Figure 2.9 – The dynamics of the main financial indicators of Air & Sea division
DSV

This year's gross profit was DKK 23,769 million (2020: DKK 16,909 million), corresponding to an annual growth of 42.3%. Higher gross profit yields per unit, combined with increased activity levels, drove this growth. Tight capacity, congestion and high freight rates on the global logistics markets drove up gross profit per TEU for sea freight and per tonne for air freight. The division's gross margin was 18.0% in 2021 compared to 22.9% last year (see fig. 2.10).



Figure 2.10 – Geographic segmentation of gross profit of Air & Sea division
DSV in 2021.

The next segment of activity is Road division. The Road division is among the market leaders in Europe and furthermore has operations in North America, South Africa and in the Middle East. The division operates more than 23,000 trucks and offers full load, part load and groupage services through a network of more than 250 terminals.

Firstly, it is necessary to analyze the market situation and performance that relates to this segment of activity. DSV estimate that the road freight market grew by around 5-7% this year compared to 2020. Growth was highest in the first half of 2021 as activity rebounded after the COVID-19 lockdowns in 2020. This year, LC estimate DSV Road grew its share across most markets because of its strong network and market position. The division also benefited from the acquisition of Global Integrated Logistics (GIL) and Globeflight in South Africa.

The main financial and operational indicators of Road division DSV are shown in table 2.6.

Table 2.6 – The main indicators of Road division DSV

(DKKm)	FY 2020	FY 2021	YTD 2022
Revenue	30,395	35,416	31,429
Direct costs	24,257	28,321	25,428
Gross profit	6,138	7,095	6,001
Other external expenses	1,021	1,122	1,056
Staff costs	2,799	3,149	2,670
EBITDA	2,318	2,824	2,275
Amortization and depreciation	0.100	0.109	0.860
EBIT	1,390	1,857	1,589

DSV Road revenue was DKK 35,416 million in 2021 (2020: DKK 30,395 million) – an annual growth of 16.2%. Our scale and strong network helped us find efficient transport solutions for customers despite disruption, and the growth was driven by organic growth in activity as well as the impact from M&A. A gradual increase in haulier rates and oil prices also had an impact on revenue.

Schematically, the dynamics of the main financial indicators of Road division DSV are presented in Figure 2.11.

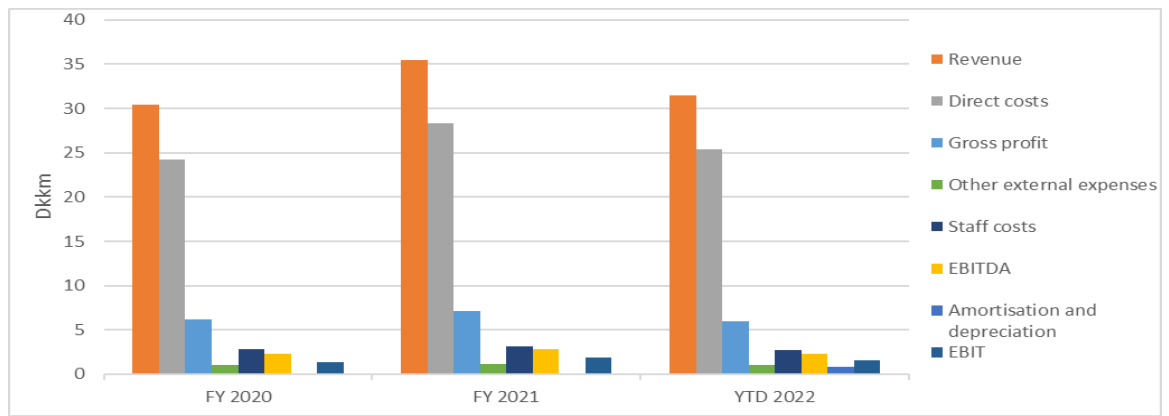

Figure 2.11 – The dynamics of the main financial indicators of Road division DSV

Gross profit was DKK 7,095 million in 2021 (2020: DKK 6,138 million), an annual increase of 15.1%. The division's 2021 gross margin was 20.0% and on a level with last year. All regions contributed positively to the growth in both revenue and gross profit (see fig. 2.12)



Figure 2.12 – Geographic segmentation of gross profit of Road DSV in 2021

EBIT before special items was DKK 1,857 million in 2021 compared to DKK 1,390 million in 2020. This 32.6% increase was driven mainly by gross profit increases. This was driven by higher productivity and the effect of the COVID-19 cost saving initiatives we implemented in 2020.

The last division of DSV is Solutions DSV, which offers warehousing and logistics services globally and controls more than 500 logistics facilities. The service portfolio includes freight management, customs clearance, order management and e-commerce solutions.

The contract logistics market grew by roughly 6-8% last year compared to 2020. The market had good momentum – with growth across most industries and e-commerce as a major driver. Warehouse capacity is in high demand, especially in Europe and North America, and labor shortages and cost inflation are increasing. LC estimate that DSV Solutions took market share in 2021. This was because of its strong service offering, new warehouse capacity and high utilization of existing capacity.

The main financial and operational indicators of Solutions division DSV are shown in table 2.7.

Table 2.7 – The main indicators of Solutions division DSV

(DKKm)	FY 2020	FY 2021	YTD 2022
Revenue	14,608	18,734	18,185
Direct costs	9,239	12,081	11,214
Gross profit	5,369	6,653	6,971
Other external expenses	1,089	1,338	1,276
Staff costs	1,449	1,664	1,677
EBITDA	2,831	3,651	4,018
Amortization and depreciation	0.248	0.330	0.391
EBIT	1,161	1,775	2,155

Schematically, the dynamics of the main financial indicators of Solutions division DSV are presented in Figure 2.13.

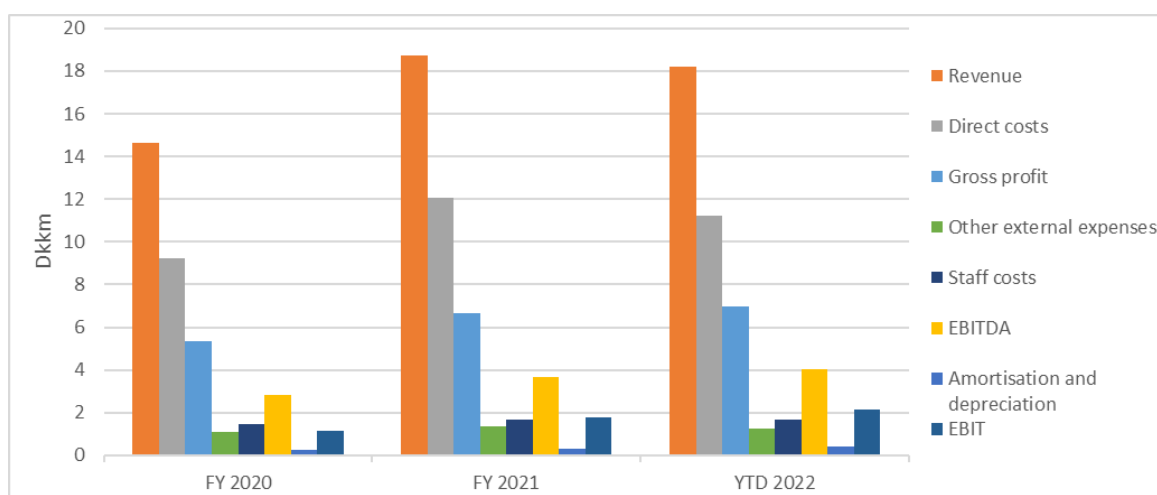

Figure 2.13 – The dynamics of the main financial indicators of Solutions division DSV

DSV Solutions revenue was DKK 18,734 million in 2021 (2020: DKK 14,608 million), corresponding to an annual growth of 28.4%. The increase was driven by organic growth and by the acquisition of GIL, which extended the reach of the division's activities. Gross profit was DKK 6,653 million in 2021 (2020: DKK 5,369 million) – an annual increase of 23.9% driven by higher activity and M&A. The division achieved a gross margin of 35.5% in 2021 compared to 36.8% last year. Gross profit of Solutions division DSV can be broken down by the following geographical areas (fig. 2.14)



Figure 2.14 – Geographic segmentation of gross profit of Road DSV in 2021

In 2021, EBIT before special items was DKK 1,775 million (2020: DKK 1,161 million). This is an annual increase of 51.3%, driven by good organic performance, improvements in the legacy DSV business and a strong EBIT contribution from GIL.

So, analysis of financial and operations activities of DSV company could reach such conclusions: two years after the acquisition of Swiss-based Panalpina, the Danish transport and logistics company is once again announcing a large acquisition: Agility Global Integrated Logistics (GIL). M&A is a well-known part of DSV Panalpina's long-term strategy and the company has demonstrated its ability many times in both acquiring and successfully integrating companies with similar business models as DSV Panalpina. The value of the GIL acquisition is USD 4.2 billion (DKK 26 billion). Global Integrated Logistics is part of Agility and one of the world's top freight forwarding and contract logistics providers (3PL). In 2020, the company had USD 4 billion in revenue, mainly related to air & sea freight and a workforce of approximately 17,000 employees.

DSV recently completed the integration of the company's largest acquisition to date, the Swiss Panalpina, and with the acquisition of GIL, DSV Panalpina will become the world's 3rd largest transport and logistics company with a combined pro forma revenue of approximately DKK 142 billion (around USD 22 billion) – an increase of around 23% – and a combined workforce of more than 70,000 employees.

Especially the Air & Sea-division, the largest division of DSV Panalpina, will be substantially strengthened with the acquisition of GIL and will consolidate the rank among the largest providers globally with close to 2.8 million containers (TEUs) and more than 1.6 million tonnes of air freight transported annually. The contract logistics capabilities, which are increasingly important due to complex supply chains and changing distribution channels, will strengthen DSV's Solutions division with GIL's additional warehousing capacity of more than 1.4 million square meters, mainly in APAC and the Middle East. Furthermore, GIL will add road freight activities to DSV's network in both Europe and the Middle East and thereby increase DSV's competitiveness across all three divisions.

2.3 Analysis of interaction between the company and supply chain participants

The analysis of interaction with the subjects of the external environment - participants of the supply chain, it is necessary to begin with the definition of the business model of the company, since it determines the degree of this interaction.

The company supports asset light business mode. This means that to provide the full range of logistics services, the company "uses" the assets of other participants in the logistics services market. Thus, to provide transportation by various modes of transport, the company concludes long-term cooperation agreements, working very closely with local carriers in each region of the world.

To provide warehousing services, the company also rents warehouses and offices in each region.

So, the key resources of a freight forwarding company are skilled people with logistics knowhow, efficient IT systems, global networks of offices and warehouses, as well as buying power and strong relations with transport companies/carriers. Global network covers more than 75 countries and consists of approximately 500 warehouses and cross-dock terminals and 600 office locations. In countries where we do not have our own network, we work with agents. The company believes that this business model keeps the entire supply chain flowing (see Fig. 2.15).

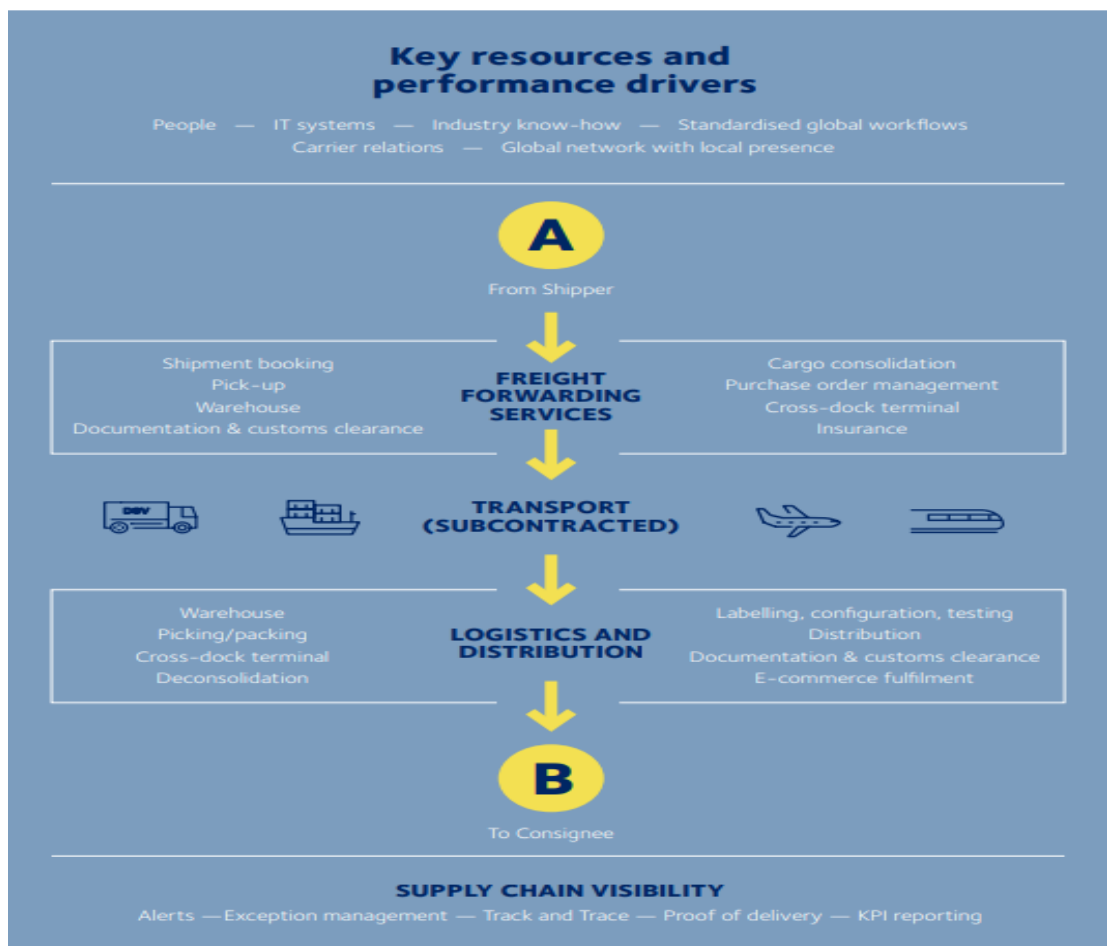

Figure 2.15 – Supply chain from A to B of DSV

Thus, the main participants of the supply chain of the company are: shippers;

- consignees;
- subcontractors (container carriers, airlines, road hauliers and railway operators);

- operators of the warehouse space market.

In order to maintain information interaction with these entities the company integrates many of its IT systems with both customers and suppliers.

In addition, the company offers the following connectivity solutions that are presented in fig.2.16.



Figure 2.16 - Connectivity solutions of DSV [72]

Company has defined five criteria for these connectivity solutions:

1. Accurate. Accuracy is essential in our fast moving and integrated business, our customers need to know where their shipments are and when they will be arriving.

2. Up-to-the-minute. Accuracy by itself isn't always enough as most of our customers also need up-to-the-minute reporting on the status of their shipments, in order for them to be able to efficiently plan their business, or to communicate to their customers.

3. Secure. DSV is renowned throughout the industry for data security and integrity. Our customers can relax in the knowledge that their data is both secure and complete.

4. Easy manageable. IT systems need to be installed, they need to be efficiently operated and the data easily filed and obtained. Our data connectivity systems are quickly installed, and are either free or offer generous installation rates and are designed to run on existing client platforms.

5. Greater flexibility. With increases in data and data overview we are seeing new opportunities to provide a degree of flexibility, offering our customers potential for savings or providing new services to their clients.

Naturally company has developed these criteria in order to give all of customers added value across the range of their operations, with the potential for measurable cost savings. The five criteria are woven into our three solutions that are designed to meet the needs of our customers no matter the size or nature of their business (see fig.2.17).

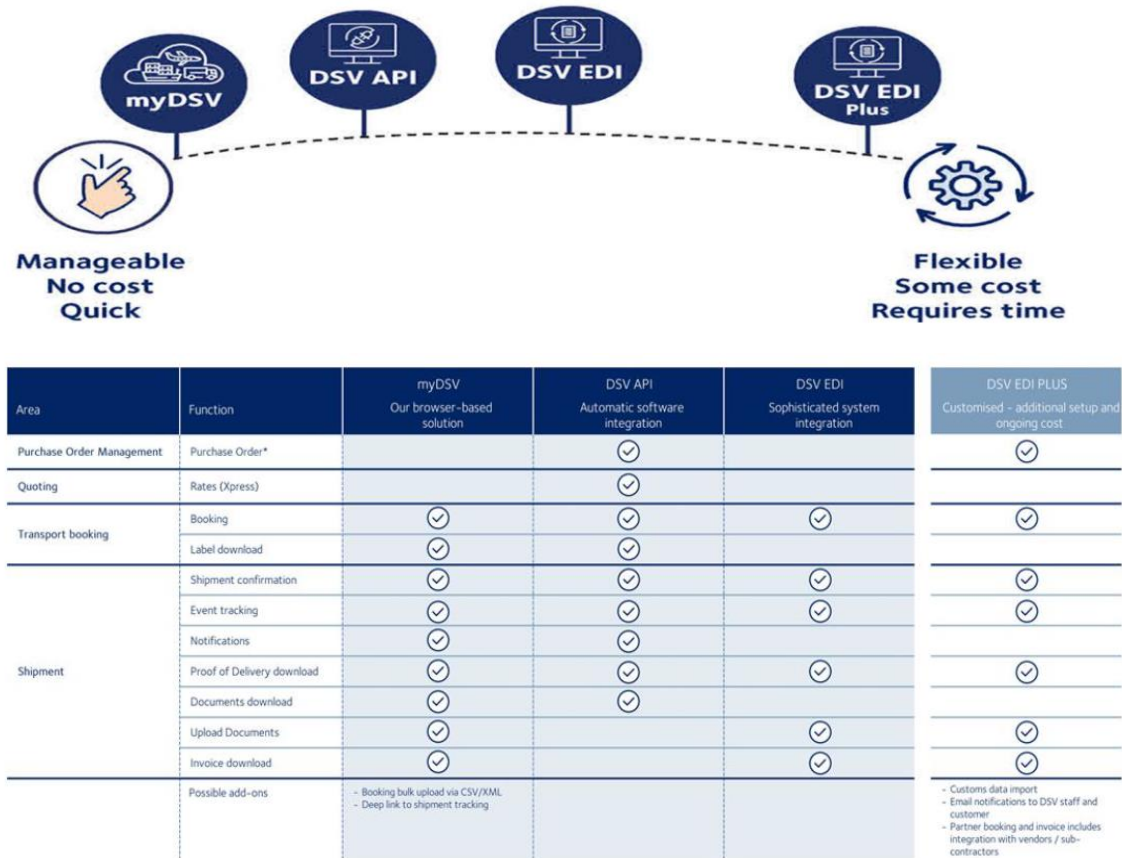

Figure 2.17 – Operating performance of connectivity solutions

These software solutions are the company's own developments, which they offer to their customers based on their functionality, namely:

- MyDSV gives an ability for fast and easy booking, tracking and support air, sea and road shipments and online access to related documents.
- DSV API (Application Programming Interface) is the modern, instant way of communicating and exchanging information electronically in real time.
- DSV EDI is our free market-leading service that automates the exchange of electronic data between DSV and your transport and warehousing systems. It handles invoices and enables your partners to book transport with us too.

Despite the existence of these software solutions, we believe that they can ensure effective information interaction conditionally, since they do not allow the company to evaluate the results of this interaction and develop measures to improve it.

As a result of the company's self-analysis of information interaction with supply chain participants, the following problems were identified, which are summarized in Table 2.8.

Table 2.8 - Summary results of a questionnaire survey on the operation of the logistics information system of interaction in the supply chain of LLC DSV Logistics

№	Problems of the logistics information system	Rating, points
1	Inadequate use of data from the LIS information base	5.6
2	Difficulties in obtaining statistical information	9.8
3	Low level of relevance (relevance of the request to the received information) data	5.4
4	Timeliness of receiving primary information in IS	9.8
5	Impossibility of using different modules when generating reports	6.8
6	Insufficient level of information support	2.3
7	Imperfect methods of analysis and forecasting of the main performance indicators enterprises	3.8
8	Time-consuming process of collecting and processing information	7.4
9	Unsystematic updating of existing information	4.6
10	Average score	6.2

The survey was conducted on the basis of a developed questionnaire, which was answered by employees who are most involved in the process of interaction - they acted as experts. The evaluation method consists in the fact that based on the data, the experts of the surveyed enterprise should give scores from 0 to 10 points. 10 is given in the case when the information flow in the columns of use, usefulness, the need to attract more complete information gets the highest score and, accordingly, 0 - the lowest. Then the data were averaged and entered into the table. The overall final score is also the average of all expert assessments.

After considering the results of summary tables of questionnaire surveys, it can be stated that it is necessary to think over the operation of the information system in

more detail and supplement it with the necessary modules. And in order to specify the information aspects of the functioning of the logistics information system of LLC DSV Logistics, it is necessary to consider it within the framework of the information model of the movement of information flows.

2.4 Chapter 2 summary

DSV is a Danish transport and logistics company that offers transport services worldwide by road, air, sea and rail. Many Ukrainian and international commercial firms are competitors of LC.

The company provides the following services on the market: third-party logistics services (3PL), Lead Logistics 4PL services, DSV Xpress, DSV Purchase Order Management, DSV Supply Chain Optimization, DSV Insurance.

The analysis of key financial indicators showed that after the acquisition of the company Agility's Global Integrated Logistics (GIL), DSV has strengthened its position in the market, the financial condition of the company has improved significantly, which is confirmed by the results of the analysis of both the company as a whole and its individual business segments.

The company operates in the market adhering to the asset light business model, which gives it the advantage of quick response to changing environmental conditions, but at the same time, increases dependence on other participants in the supply chain. The main participants of the supply chain have been identified, including shipper, freight forwarding services, subcontracted transport, consignee.

In order to improve information interaction between established participant of the company`s supply chain it is needed to determine the directions of such improvement that will be developed in the next chapter of diploma thesis.

CHAPTER 3

PROJECT PROPOSALS FOR IMPROVING THE INFORMATIONAL INTERACTION OF SUPPLY CHAIN PARTICIPANTS

3.1 Development of directions for improving the information interaction between LLC DSV Logistics and supply chain participants

Logistics is about 10-15% of the total costs. Small and medium-sized businesses without experience in supply chain management suffer losses due to low operational efficiency. Companies specializing in warehouse operations, 3PL operators, can help to establish processes. But usually, large logistics providers rarely cooperate with small companies.

In subsection 2.3, the main actors of interaction in the supply chain were established. The company has established long-term relations with subcontractors, the company does not operate their assets. the main problems of interaction are between the company and customers, the company and operators of the warehouse space market. Between the company and the customers - the company must monitor customers, respond to their needs, monitor their number, effectiveness of interaction, reports on each customer, etc. With operators of the warehouse space market - the company, depending on customer demand, rents warehouse space in order to be able to provide complex services.

That is, the company has a need for effective information interaction with the operators of this market, namely, it must have operational information about the class of warehouses, capacity, location, services provided, storage conditions, etc. Taking into account the fact that some of the warehouse complexes are destroyed or are located in temporarily occupied territory, this information becomes very relevant and there is a dissonance in the warehouse real estate market of Ukraine: warehouses are in demand, but the search, analysis and selection of the optimal premises for business is

complicated. It takes weeks and months to select real estate, and the chance of falling for an unscrupulous warehouse owner or broker is extremely high.

Based on these statements it is needed to develop directions for improving the information interaction of LLC DSV Logistics with supply chain partners, that is :

1. with warehouse real estate market operators.
2. with customers.

To improve the interaction between the company and warehouse real estate market operators it is proposed for the company to become a client of the information service - WareTeka Warehousing, which has an advantage for the company - for it, information services are free, the warehouse operator pays for them [74].

WareTeka Warehousing is a service that simplifies cooperation with logistics operators. It enables small and medium-sized businesses to make deals with 3PL operators online.

The Warehousing service takes over all the operational work of managing warehouse operations — signing contracts, billing and processing, explaining the services of 3PL operators, etc.

Another possibility of WareTeka Warehousing is the selection of the optimal buffer warehouse for temporary storage of goods. During peak seasons (for example, before the New Year holidays), companies can lose profits. Often this is due to the fact that the product is not in stock or there have been supply interruptions. To avoid such situations, experienced entrepreneurs create reserves of goods - "buffer" stocks. Sometimes there is not enough space in the main warehouses, so you need to look for additional space for temporary storage.

The founders of this service believe that they can solve the following problem: "Build a bridge between large logistics providers and small and medium-sized businesses. This segment of entrepreneurs is suffering the consequences of the quarantine. Logistics, which should reduce costs, only causes them headaches. Usually, 3PL-providers do not work with small companies - operating costs are not reimbursed due to small volumes of turnover, lengthy contract signing procedure and complex integration with warehouse systems. "

It is easy to connect to the web service - you need to register on the WareTeka platform, get a personal account, specify the volume of products for the month, bring the goods to the partner's warehouse.

The interface independently communicates with the systems of 3PL operators via API. In addition to what can be done with the help of a personal account shown in fig. 3 1.

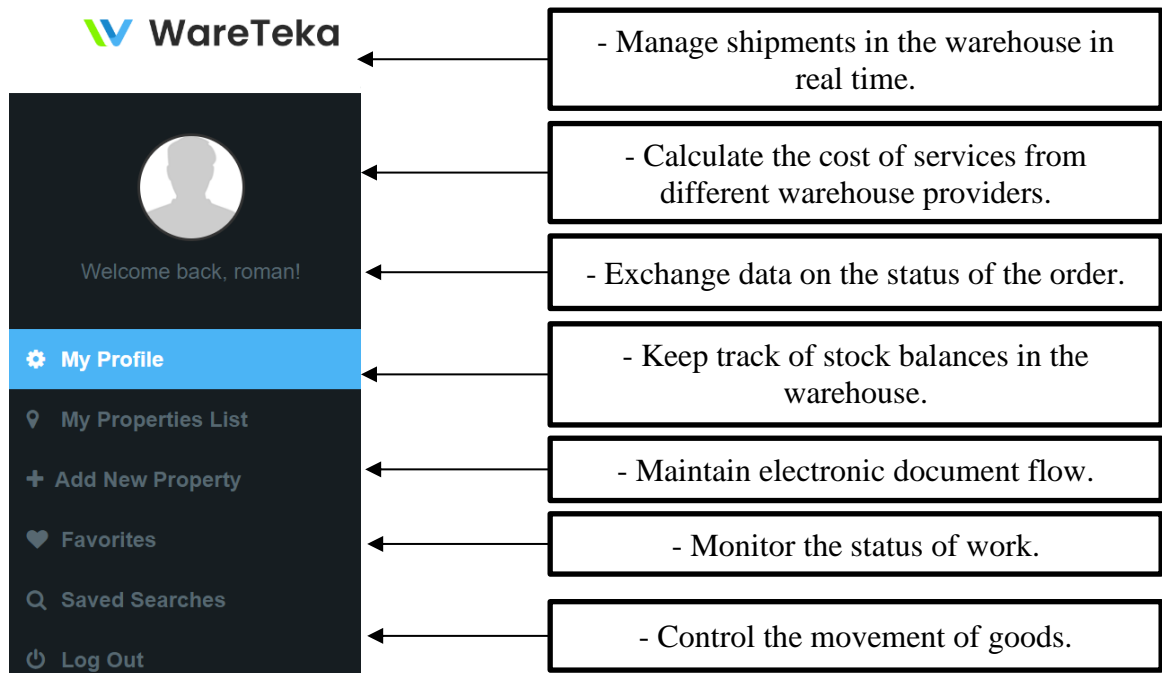

Figure 3.1 – Warehousing service functionality

The algorithm of interaction with WareTeka Warehousing service:

1. WareTeka Warehousing service receives an application from the company.
2. Specialists of WareTeka Warehousing service study the specifics of business operations: what needs to be stored and in which cities, pallet turnover indicators, and other criteria.
3. Specialists of WareTeka Warehousing service create a list of logistics providers at the request of the client. They indicate the cost and services and show the advantages and disadvantages of various cooperation options.
4. Specialists of WareTeka Warehousing service prepare and approve a commercial proposal.

5. Specialists of WareTeka Warehousing service help the company sign a contract with a warehouse real estate market operators.
6. Specialists of WareTeka Warehousing service e set up communication with the warehouse real estate market operators (using a personal account).
7. Specialists of WareTeka Warehousing service ensure the exchange of information about the shipment and receipt of goods between the two parties.

The logistic structure of these processes is shown in fig. 3.2.

WareTeka Warehousing cooperates with logistics providers that work with various types of goods: food products, electronics, construction materials, fertilizers, dangerous goods, etc.

In their base there are warehouses that will provide optimal conditions for storage for any needs, such as those shown in fig. 3.3.

Before starting cooperation with all logistics providers, the company checks the storage conditions in their warehouses. WareTeka Warehousing specialists visit the object in person or evaluate it in online tour mode. Thus, we can guarantee the reliability of every 3PL operator on the platform.

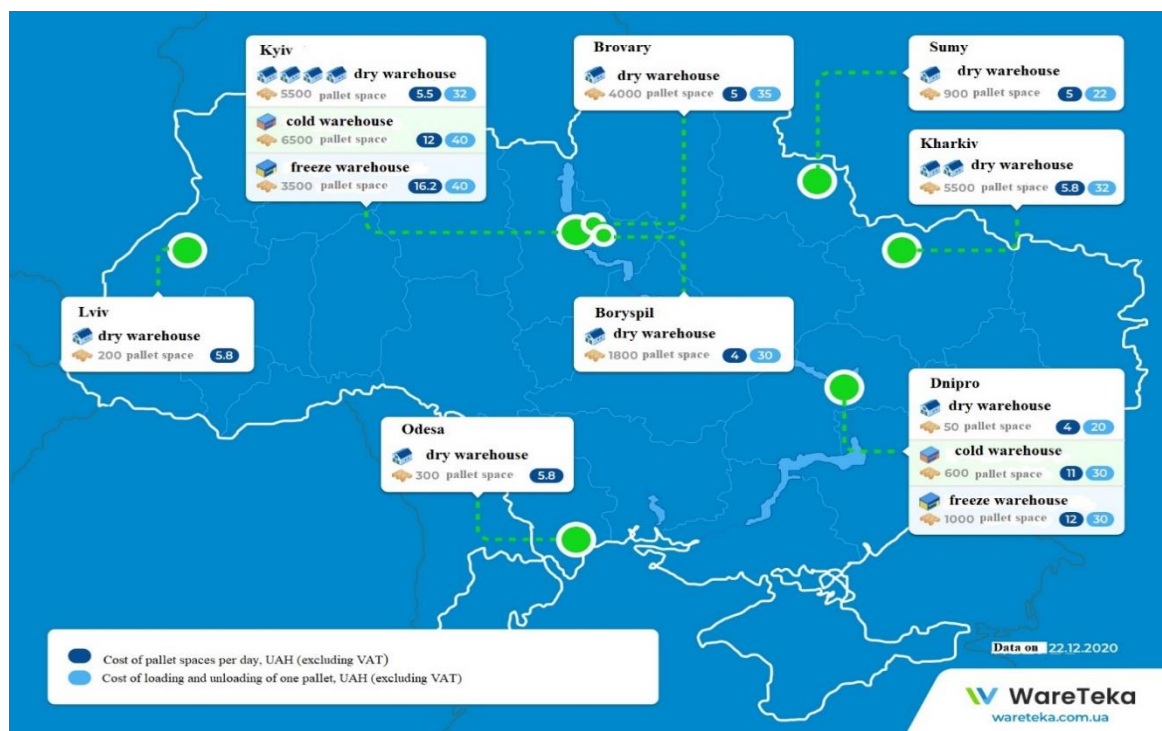

Figure 3.3 – Types of warehouses offered by the Warehousing service

LOGISTIC STRUCTURE



Figure 3.2 – Logistics structure of the WareTeka Warehousing service

Therefore, WareTeka guarantees the safety of your products at all stages of delivery in the course of cooperation with logistics providers-partners of our platform. Fig. 3.4 shows which compositions can be selected in the personal cabinet.

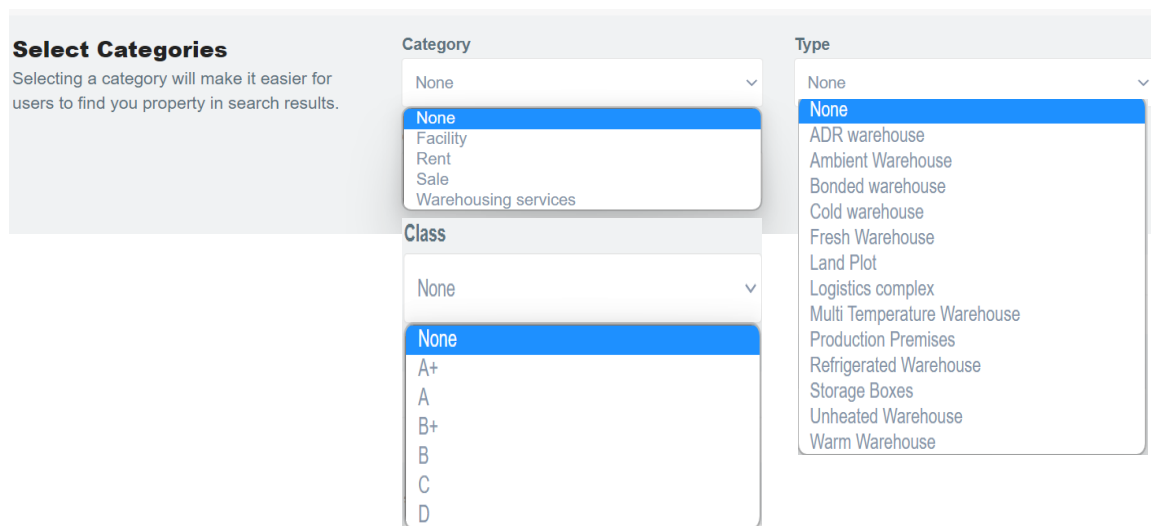

Figure 3.4 – Categories of proposed warehouses

In the personal office, as shown in Figure 3.4, the office and logistics complex "Makarivskiyi" (Makarivskiyi district, Kyiv region, Kolonshchyna) was chosen for storage of goods. It has the following details: Warehouse ID – 71406; price - UAH 195 per square meter; class – A; type of warehouse - logistics complex, warm warehouse; area for rent - 61,992 m²; mechanization - non-mechanized. The complex suited all parameters, but unfortunately, as it turned out, this complex was destroyed by artillery bombardment during active hostilities in the area of its location from February 25 to March 9, 2022.

Currently, the WareTeka Warehousing service has already been integrated with the first logistics provider — Pakline Logistics. In addition, WareTeka agreed on cooperation with 5 more 3PL operators and fulfillment providers, among which will be the logistics company LLC DSV Logistics. Logistic operators are gradually being connected to the system.

For the second way of improving the information interaction of the logistics company LLC DSV Logistics with customers, we suggest implementing a CRM

system. The development of the CRM implementation project will be discussed in subsection 3.2. The definition of CRM stands for Customer Relationship Management, which means "customer relationship management" and refers to all strategies, methods, tools and technologies used by a business to develop, retain and attract customers. Customer Relationship Management is a special approach to conducting business, in which the customer is the first priority of the company's activities.

The main goal of implementing a CRM strategy is to create a single ecosystem for attracting new and developing existing customers. Managing relationships means attracting new customers, turning neutral buyers into loyal customers, forming business partners from regular customers.

3.2 Development of the CRM implementation project

As was mentioned in chapter 1, CRM system is a program that helps organize the process of communication with customers. Its main goal is to bring order to sales processes, standardize them, make work easier, faster and more convenient. Depending on the tasks, CRM can be installed on a computer or used as a cloud service. Most modern CRM systems also have a mobile application for working with the customer base from anywhere [78].

LLC DSV Logistics chose the Ukrainian CRM program from the manufacturer FIRMAO, because it is a popular online CRM system that combines marketing and customer service [76].

Let's consider Firmao's CRM software in more detail:

1. Firmao is an online CRM software. Technical companies support gets the highest positions in the rating every year. The modular structure of Firmao makes it easier to adapt to specific needs than in the case of competing programs (Comparable CRM systems: Bitrix24, Hubspot, Pipedrive, Salesforce, Zoho).

2. Thanks to the implementation of Firmao's CRM software, you can create a customer database that will allow you to reduce the time it takes to attract customers, increase conversion at each stage of the sales process, and effectively and comprehensively serve regular customers. Firmao - a CRM system for business helps to manage the work of the sales department, both from the point of view of the sales funnel, and acts as a contact center for the company's regular customers.

3. The CRM program from Firmao is designed for small and medium-sized production, service and sales companies. It is implemented in companies that need contact with potential or regular customers. CRM software from Firmao is the best system for companies planning dynamic development.

4. Implementation of Firmao's CRM system is easy and fast. This takes approximately 1-2 weeks to 5 months, depending on the company and the amount of implementation work in it.

5. 50% discount on products valid until the end of the year.

Functionality of CRM program is shown in fig. 3.5.

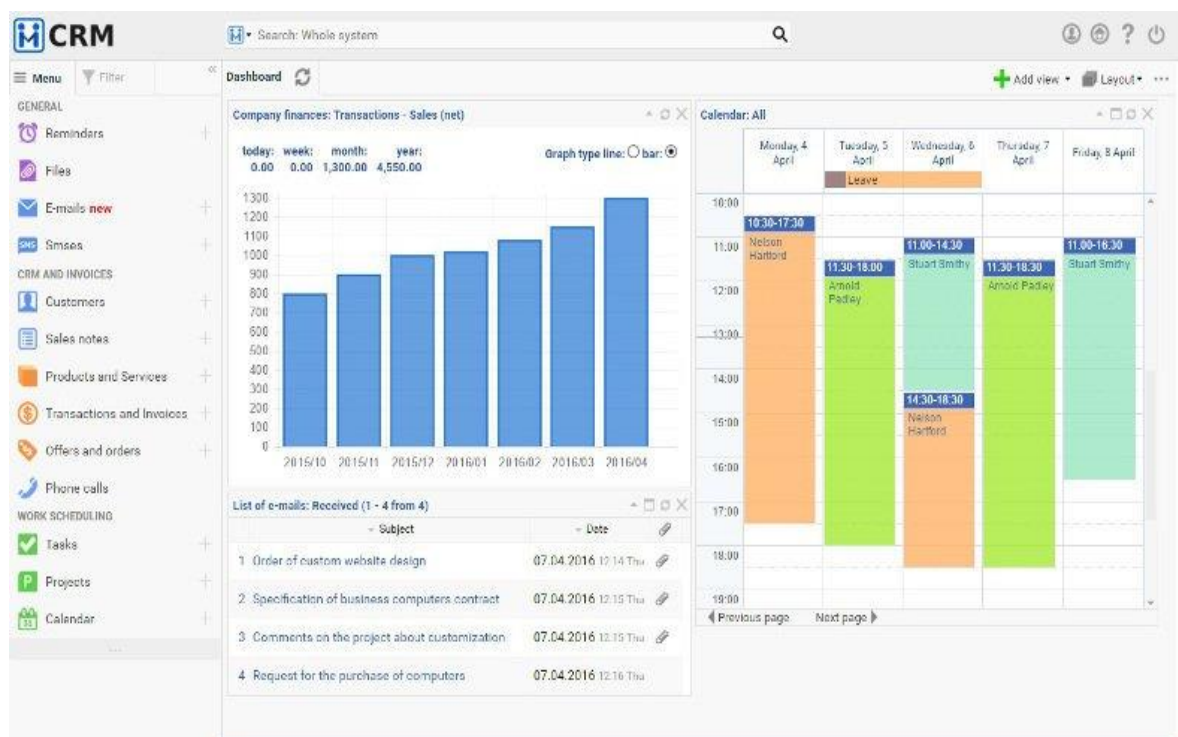

Figure 3.5 - Online CRM system

Simple management of the client base comes as a bonus, namely:

1. Many sources of opportunity.
2. Automation of the sales process.
3. Increase in sales volume.
4. Effective contact with the client.
5. Comprehensive customer service.
6. Fulfillment of orders for customers.

Among the listed licenses in fig. 3.6. LLC DSV Logistics is most suitable for the third option, due to its multifunctionality.

Standard 499€ 199€ для одного користувача на місяць	Professional 699€ 309€ для одного користувача на місяць	Enterprise 1199€ 569€ для одного користувача на місяць
CRM - Управління Відносинами з Клієнтами	Всі функції Стандартної версії, а також	Всі функції Професійної версії, а також
Інтеграція з електронною поштою	Створення додаткових полів для Ваших даних	Модифікації (за додаткову плату)
Рахунки з ГДВ, квитанції та чеки	Чат, Livechat та Callback	Інтеграція з Календарем Google
Timesheeting, календар та проекти	Шаблони рахунків, пропозицій та угод з можливістю редагування	Електронна пошта та телефонні опитування
Звіти, графіки	Шаблони електронних листів та автовідповідей	Інтеграція сервісу SMS
Пропозиції та замовлення	Мережевий диск - 10ГБ на ліцензії	Інтеграція з інтернет магазинами
Мережевий диск - 2ГБ на ліцензії	Інтеграція з телефонією VoIP	Інтеграція з системами кур'єрів
Мобільні додатки для Android та iOS	Автоматичне циклічне створення рахунків	Інтеграція з Mapbox
Нагадування про ключові терміни	Групи цін та ціни індивідуально	Обіг документів та завдань
Інтеграція з Przelewy24	Шанси продажу	ERP-продукція
Безкоштовна технічна підтримка 8-16 пн-пт (електронна пошта)	OCR - автоматизація обробки рахунків	Інтеграція з Zapier
	Діаграми Ганта, Канбан	Панель кіліста
	План продаж	Автоматизація, Процеси
		аналізи
		Безкоштовна технічна підтримка 8-16 пн-пт (електронна пошта, телефон), цілодобово / 365 (електронна пошта)

Figure 3.6. – CRM program options

Setting the goals of CRM-interaction in a generalized form involves the completion of four mandatory stages:

- 1) identification and analysis of trends that can be observed in the company's environment;
- 2) establishment of the general goal of the organization;
- 3) construction of a hierarchy of goals ("tree of goals") of CRM activities;

4) setting individual goals and objectives depending on the group of clients as a tool for ensuring their fulfillment.

The key goals of LLC DSV Logistics client-oriented strategies are listed in Table 3.1.

Table 3.1 - Key objectives of LLC DSV Logistics client-oriented strategies depending on the basic development strategy

General development strategies		Key goals of the CRM strategy	Supporting objectives of the CRM strategy
1		2	3
Concentrated growth	Strengthening positions in existing markets	Development of relationships with customers and formation / increase of customer loyalty	Building a system of relationships with clients, ensuring a balance of interests; growth of loyalty and customer base
	Development of markets	Development of promotion channels	Attracting customers (lead generation); increasing profitability; improvement of the sales process
	Development of the offer	Development of a value proposition based on its approximation to customer needs	Development of the assortment with added customer value; introduction of better service
Integrated growth	Growth through increased control over suppliers (reverse vertical integration)	Operational excellence/value proposition development	Cost reduction and increase in sales margin; increase in business reputation; simplifying marketing
	Growth due to the strengthening of control in the field of service, provision of food services	Development of relationships with customers, formation/increase of customer loyalty	Ensuring customer satisfaction through service; increase in loyalty; building a system of long-term relationships with clients
	Growth through mergers/acquisitions (horizontal integration)	Operational excellence/development of promotion channels	Reduction of costs for marketing and lead generation; increase in productivity; improvement of the promotion process

Continuation of Table 3.1

	1	2	2
Diversified growth	Concentric (related) growth	Development of the value proposition due to product differentiation	Development of the assortment with added customer value; creation of competitive advantages; introduction of better service
	Growth through horizontal diversification to enter new markets	Development of promotion channels; operational excellence based on the implementation of own standards	Expansion of the client base; Building a system of relationships with clients in new markets; ensuring profitability
	Growth through conglomerate diversification	Development of relationships with clients and formation/increase of client loyalty; development of the value proposition	Building a system of long-term relationships with clients; creation of unique competitive advantages, strengthening of loyalty

Target indicators of CRM activities of the organization are established based on its market position and financial results.

For example, the set of goals of the company's CRM measures, namely LLC DSV Logistics in Ukraine, can include:

- reduction of labor costs for the production of services;
- stabilization of mutual relations and reduction of complaints from representatives of the local community about the company's activities, reduction of the number of fines;
- activation of personnel potential;
- improving the quality of procurement of goods and services, reducing unused stocks.

We offer to improve the quality of services based on the implementation of the CRM system, which provides for effective interaction with the client. Based on the results of the implementation of the CRM system, the effectiveness of the chosen solution according to the proposed concept was calculated.

To calculate efficiency, let's specify some parameters. 30 people (employees of the client department, marketing, managers) will be direct users of the CRM system. Before the implementation of the system, these employees used separate, inconsistent programs to solve business tasks (mainly from the MS Office package).

The investment return period is 2 years.

To calculate the total cost of the project (CCO), 6 parameters were analyzed: monthly license deductions; consulting costs; costs for the systematization of internal business processes; internal implementation costs; employee training costs; annual internal costs for maintenance of the CRM system. Consider all these costs in more detail:

1. License payment.

The cost of a CRM system license with full access for one user is UAH 569 per month (including VAT), and for 30 users - UAH 17,070 per month. Annual costs for 30 users will amount to UAH 204,840.

Within two years, LLC DSV Logistics will pay UAH 409,680 license payments (see Table 3.2).

Table 3.2 - Licensing deductions for the LLC DSV Logistics CRM system

No	Name	Value, UAH
M1	License payments per employee per month	569
M2	License d payments for 30 employees per month	17070
M3	License payments per year	204840
Mt	Total license payments for 2 years	409680

2. Additional hardware and software.

Implementation of the CRM system requires changes in the existing IT infrastructure. On the “Rozetka” online marketplace, 4 additional Artline business T17 v14 database servers were purchased at the price of UAH 26,454 per piece (including VAT) and middleware for each server, Microsoft Windows Server Standard 2022 64Bit English 1pk OEM DVD 24 Core (P73-08346) in the amount of 4 pieces with a

total cost of UAH 239,916 (UAH 59,979 for 1 piece, including VAT), purchased at the Ukrainian omnichannel retailer of appliances and electronics "MOYO".

The costs of additional equipment for the LLC DSV Logistics CRM system are shown in Table 3.3.

Table 3.3 - The cost of additional equipment for the LLC DSV Logistics CRM system

No	Name	Value, UAH
N1	Equipment: 4 Artline business T17 v14 servers	105816
N2	Windows Sever Standard 2022 software	239916
Nt	Total expenses	345732

3. Consulting.

To implement the CRM system LLC DSV Logistics used the consulting services of the integrator company "FIRMAO", from which it purchased the CRM program. This work lasted 4 months and included the analysis of internal business processes, the development of an implementation plan and the customization of the CRM system for the specific needs of the LLC DSV Logistics branch. Professional program installation and initial consulting services cost UAH 26,600. Additional annual costs of UAH 20,000 for system maintenance were added to them. The price of the work of an analyst/programmer is additionally paid - UAH 1,200/hour, for a 6-hour day of work - UAH 7,200, for 2 days of work of 12 hours on working days per week - UAH 14,400, for four working weeks per month - UAH 57,600, for 4 months of work - UAH 230,400. In total, the integrator's professional services for a two-year period amounted to UAH 297,000. Consulting costs for the CRM system of LLC DSV Logistics are shown in Table 3.4.

4. Costs for the systematization of internal business processes.

The implementation of the CRM system was accompanied by the creation of a working group of employees to ensure maximum integration of internal business processes with the IT solution

Table 3.4 - Consulting costs for the CRM system of LLC DSV Logistics

No	Name	Calculation	Value, UAH
P1	Analyst/programmer labor price/hour	-	1200
P2	The price of work of an analyst/programmer / 4 months.	-	230400
P3	Software installation and initial consulting	-	26600
P4	Technical support per 1 year	-	20000
Pt	Total costs for two years	$P2+P3+(20000*2)$	297000

In our case, a "working group" was created, which for four months participated in the implementation of the CRM system together with the consulting department of the integrator. The team included 5 people: the director of the main branch, the heads of the sales, marketing, back office and IT departments. The members of the "working group" spent about 25% of their time during the four months. The calculation assumes that the year 2022 consists of 365 days, including 249 working days with 40 working hours per week, or 1,987 hours per year. Total internal labor costs for planning and designing CRM implementation amounted to UAH 57,954 (see Table 3.5).

Table 3.5 - Costs for business processes for the CRM system LLC DSV Logistics

No	Name	Calculation	Value, UAH
X1	Working group, persons	-	5
X2	Duration of work, months	-	4
X3	Loss of working time, %	-	25%
X4	Labor cost, person/hour.	-	70
X5	Annual working time fund, hours	-	1987
Xt	Total expenses	$X1*X2*X3*X4*X5/12$	57954

5. Internal implementation costs.

The working group of five people also spent an additional week, or 40 working hours each, on the development of a special awareness campaign on the use of the CRM system, as well as in addition to the existing regulations of the interaction of LLC DSV Logistics employees, taking into account the implemented system. Implementation costs for CRM system LLC DSV Logistics are shown in Table 3.6.

Table 3.6 - Implementation costs for CRM system LLC DSV Logistics

No	Name	Calculation	Value, UAH
I1	Working group, persons	-	5
I2	Duration of work, hours	-	40
I3	Cost, person/hour.	-	70
I4	IT staff	-	2
I5	The cost of IT personnel, person/hour.	-	56
I6	Duration of work, hours	-	40
It	Total Costs	$I1 * I2 * I3 + I4 * I5 * I6$	18480

At this stage, two specialists from the IT Department joined the "working group" to implement synchronization between the IT infrastructure and the CRM system available in LLC DSV Logistics. Being fully loaded with this project, specialists worked on the implementation for about 40 hours during the month. The total internal cost of labor at this stage was UAH 18,480.

6. Employee training costs.

Two employees of the department of methodological support were involved in the process of developing training standards and CRM work regulations. Specialists spent 40 hours developing the training module. The salary of one specialist is UAH 50.5 per hour. Each of the 30 users completed six hours of training. Total costs for the training program at LLC DSV Logistics UAH 13,130 (see Table 3.7).

Table 3.7 - Training costs for the CRM system LLC DSV Logistics

No	Name	Calculation	Value, UAH
L1	Outsourcing, persons	-	2
L2	Cost, person/hour.	-	50.5
L3	Duration of work, hours	-	40
L4	Users, persons	-	30
L5	Cost, person/hour.	-	50.5
L6	Duration of work, hours	-	6
Lt	Total Costs	$L1*L2*L3+L4*L5*L6$	13130

7. Annual internal costs for maintenance of the CRM system.

According to the internal audit, two specialists of the IT Department are enough for the internal administration of the entire CRM system. On average, they spend 25% of their working time on maintaining the CRM system. Taking into account the monthly salary, which is equal to UAH15,000, we get expenses of UAH180,000 per year or UAH 54,000 for two years (see Table 3.8).

Table 3.8 - Service costs for the CRM system of LLC DSV Logistics

No	Name	Calculation	Value, UAH
K1	Period	-	2
K2	Working time costs, %	-	25%
K3	Annual salary	-	180,000
K4	Expenses per year	$K1*K2*K3$	90000
Kt	Total project costs	$K4*2$	180,000

8. Depreciation deductions.

Depreciation deductions are calculated when the book value of the equipment exceeds UAH 10,000. In our case, the cost of 4 servers (additional hardware and software) is UAH 345,732, including VAT. According to the classification of fixed assets included in depreciation groups, servers of different performance belong to the

2nd depreciation group. Property from this group has the minimum permissible period of use of the equipment is an accelerated period of 2 years.

The salvage value of the object of the fixed asset is set at UAH 45,732. The cost of the above-mentioned depreciable equipment will be: $UAH\ 345,732 / 1.2 - 45,732 = UAH\ 242,378$ (see Table 3.9).

Table 3.9 - Depreciation deductions for the CRM system LLC DSV Logistics

No	Name	Value, UAH
J1	Useful life, year	2
J2	Monthly depreciation deductions	10099.08
J3	Annual depreciation deductions	121189
Jt	Total depreciation for the project	242378

We calculate the annual amount of depreciation according to the following formula:

$$A = A_m / K, \quad (3.1)$$

where A_m - the cost of the fixed asset (that is, the initial cost minus the liquidation cost), which is amortized, hryvnias;

K - the term of useful use of the fixed asset, years.

According to the example, the annual amount of depreciation will be:

- for a useful life of 2 years:

$$A = UAH\ 242,378 / 2\ years = UAH\ 121,189.$$

$$\text{Monthly depreciation amount: } UAH\ 121,189 / 12\ months = UAH\ 10,099.08.$$

The total costs for the implementation of the CRM system are shown in the table.

3.10.

Table 3.10 - Total costs for the implementation of the LLC DSV Logistics CRM system

Name	Costs	1 year	2 year	Total
License payments	0	204840	204840	409680
Equipment	345732	0	0	345732
Consulting	257000	20000	20000	297000
Development of business processes	57954	0	0	57954
Implementation	18480	0	0	18480
Teaching	13130	0	0	13130
Service	0	90000	90000	180,000
Depreciation deductions	0	121189	121189	242378
Total	692296	436029	436029	1564354

Thus, the implementation of CRM-measures of LLC DSV Logistics based on the recommended strategy of sustainable development of the enterprise should include the following practical steps: stratification of LLC DSV Logistics interaction groups, monitoring and clear definition of the interests of the main interaction groups, determination of priorities in cooperation with various customer groups, distribution of functions with implementation of CRM activities LLC DSV Logistics, planning activities for the implementation of the CRM strategy in view of the updated approaches, evaluation of the results of the implementation of tactical and operational tasks.

3.3 Calculation of project performance indicators

The main participants of the supply chain, according to the company's business model, are clients and subcontractors. To analyze the level of information interaction with clients and the efficiency of LIS LLC DSV Logistics we used queuing theory (theory of waiting lines).

The logistics information system (LIS) serves as a means of logistics management of material flows at LLC DSV Logistics.

It provides the possibility of functioning of the logistics system in real-time mode. In terms of content, LIS is characterized by the following features:

1. The complexity of the organizational and functional subsystems and the numerous interrelationships between its constituent elements.
2. A variety of supporting subsystems, which include functional, mathematical, informational, technical, technological, software, linguistic, organizational and legal types of support.

The structure of the LIS is proposed to be depicted in fig. 3.7.

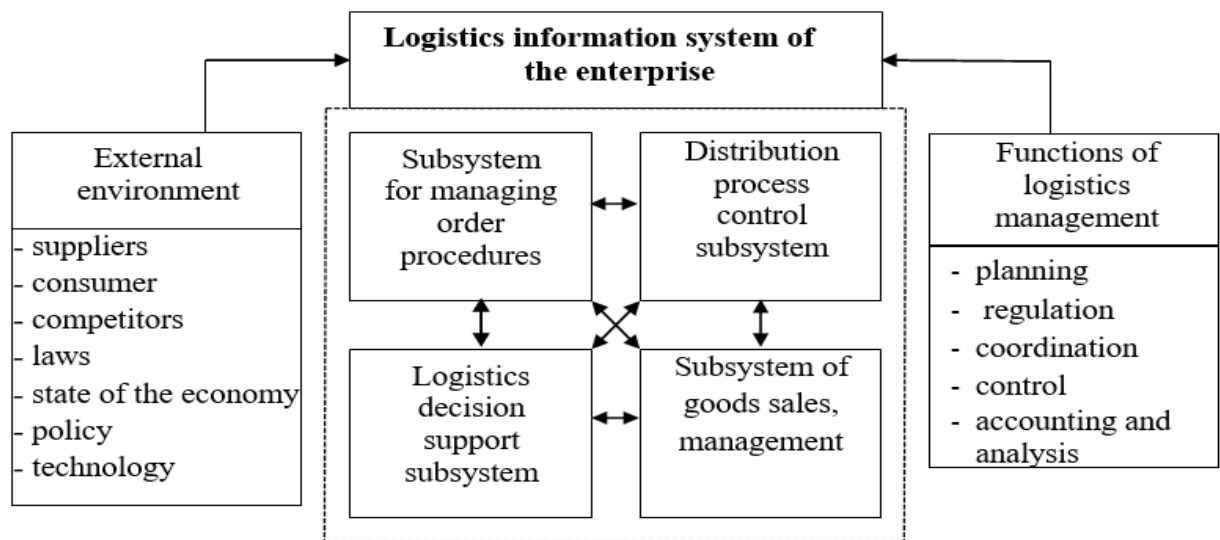

Figure 3.7 - The structure of the logistics information system LLC DSV Logistics

For this purpose, we will consider LIS as a logistics web system. After all, LIS LLC DSV Logistics is a locally distributed web system consisting of a large number of web servers and mechanisms for routing incoming information flows among several server nodes. Each server node is a store of information in each department and these nodes are connected in a single web system with the servers of the central office, the regional centers and the computers of suppliers, that is, with all participants of the LLC

DSV Logistics. After receiving the information flows in the server nodes, through the corresponding request to the database, the information is moved through the communication channels to the corresponding recipient of this data.

Although information acts as a driving force behind the activity of the logistics system and ensures its openness – able to adapt to new conditions, it is still static. In this regard, the concept of information flow is introduced to the key terms of logistics, which, by its very nature, is dynamic and related to the movement of information in space and time.

The main parameters of the information flow include:

- source of occurrence;
- periodicity;
- amount;
- speed of transmission and reception;
- flow intensity.

The path along which the information flow moves, in general, may not coincide with the route of movement of the material flow. It is based on the movement of paper or electronic documents. Depending on this, it can be measured either by the number of processed and transferred units of paper documents or by the total number of document lines in these documents, or by the amount of information (bytes) contained in a particular message.

The speed of transmission of information flows is measured by the ratio of the amount of processed or transmitted information per unit of time (bit/s). According to observations, the speed of transmitting and receiving information at LLC DSV Logistics is 79 Kbit/s on average.

The intensity of loading the information system by streams is determined in Erlang (Earl) and corresponds to the ratio of the total number of transmitted or received messages that were transmitted during the working day to the number of messages related to network management during the maximum loaded working hours.

Analyzing the mode of operation of the information system at LLC DSV Logistics, they came to the conclusion that, according to observations, the department

is maximally loaded for 4.5-5 hours, and the management of information flows in the information system is carried out on average for 12 hours.

As researched, on average, about 224,961 Kilobytes of information are sent to and from the information system per month. Over 8,239 Kilobytes of data are accumulated in the database during one day. Also, after the research, it became known that 55% of information flows enter the information system during the hours of the highest load of branches, which is 4218.6 Kilobytes of information. The rest of the information flows, which is 45% (4020.4 Kilobytes), is accumulated or sent during working hours.

Thanks to observations, the indicator of the intensity of information flows in the logistics information system of LLC DSV Logistics was determined, which is equal to $\frac{4020,4}{4218,6} = 0,95$ (Earl).

To determine the volume of information flow, it is necessary to determine the ratio of paper and electronic documents. From our own observations, it is known that about 15,000 documents are transferred and accepted per month during the activities of one LLC DSV Logistics branch. 70% of them are electronic data. So, after calculating the ratio, we will get 5500 paper documents and 9500 electronic data. After analyzing the database, the LLC DSV Logistics branch found that the average size of one message is 34.6 Kilobytes. We suggest in appendix A to consider the values of the main parameters of electronic documents that reproduce the process of managing the logistics system of LLC DSV Logistics.

The considered methods of measuring the volume, speed and intensity of information flows are used to improve the efficiency of the logistics information system of the enterprise. After all, electronic record keeping allows you to systematize and combine information, track its movement and control the order of transmission.

The main prerequisite for the formation of an electronic information flow is, on the one hand, the formation of a library of document forms, and on the other hand, the creation of arrays with calculated indicators of operational planning, normative, reference, contractual and other indicators, which will then be used in the preparation of the necessary paper forms of documents - blanks paper information flows include revenue orders and acts of acceptance received from suppliers to warehouses; limit

(limit-collective) documents to be issued from the warehouse; routing and technological documents; documents on shipment from the warehouse of goods, including payment documents for the bank, orders, reports, standards, technological instructions. In addition to planning and operational documents, there are also various statistical reports, marketing research data,

On average, each paper document consists of 30 document lines. Consider in the table. 3.11 total monthly volumes of these paper information flows reflecting the functions of managing the logistics system of LLC DSV Logistics.

Table 3.11 - Types and volume of paper information flows in one branch of LLC DSV Logistics per month.

Types of paper information	Number of documents, pcs.	Amount, document lines
Planned	950	30 x 950=28500
Operative	1050	30 x 1050=31500
Statistical	600	30 x 600=18000
Unsystematized	400	30 x 400=12000
In general	3000	90000

As can be seen from the table. 3.11, the total volume of paper information flows per month in one branch of LLC DSV Logistics is 90,000 document lines. As you know, all these information flows form electronic primary documentation.

According to observations, it is known that one document line is equal to 19.5 Kilobytes. When counting, we will get a volume of 1462500 Kilobytes of electronic data. Summarizing the data of appendix A and table. 3.12, we will receive an indicator equal to 1627000 Kilobytes or 1.6 Gigabytes of electronic information per month for one branch of LLC DSV Logistics.

For such a volume of information, it is necessary to establish the effective operation of the information system and computer equipment. After all, the efficiency of the logistics system and the state of communication processes at LLC DSV Logistics

as a whole depend on it. Therefore, the most important task for us is first of all finding the ratio of forms and types of computer support of information flows, for which the informatization of the system as a tool of logistics management is mostly intended.

If we display the LIS LLC DSV Logistics through queuing theory (theory of waiting lines), we can consider its configuration, each element of which is a separate system that functions with a certain algorithm. On the set of one computer system, the sources of information flows (DIP) are set, the maintenance of which is performed by the elements of the set according to the given algorithms. Devices such as: processors (PR), RAM (OP), input/output channels (KVV), external input/output devices (PVV) act as elements of the queuing theory (theory of waiting lines), set. Schematically, in fig. 3.8, we demonstrate the structure of a separate computer system (OS), which reflects the movement of information flows in the process of product promotion LLC DSV Logistics.

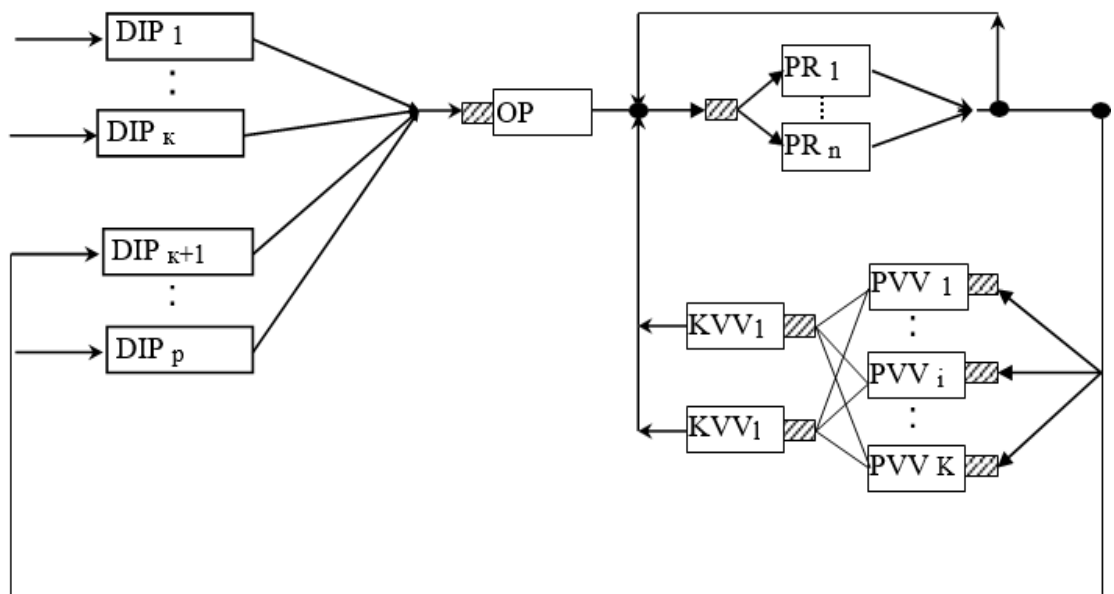

Figure 3.8 - The structure of the computer system LLC DSV Logistics presented in the form of a queuing theory (theory of waiting lines), network

As a result of the simulation, statistical data were determined for four information flows that function in a separate OS. Using this formalized structure of the computer

system, we can simulate its operation based on the fact that all systems, in turn, are also queuing theory (theory of waiting lines).

Each queuing theory (theory of waiting lines), includes in its structure a certain number of service devices, which are called channels (devices, lines) and are designed to serve a certain flow of requests (requirements) that arrive at the entrance to the LIS, mostly not regularly, but at random moments of time. The service of these information flows continues intermittently, after which the channel is released and is ready to receive the next request. The random nature of the flow of applications and their service time leads to uneven loading of the queuing theory (theory of waiting lines), i.e., at other times, unserved applications may accumulate at the entrance to the LIS, which leads to overloading of the queuing theory (theory of waiting lines); and sometimes, when information flows do not enter the LIS, there is a simple channel system.

To evaluate the effectiveness of the implementation of the CRM system, we will use the indicators of the the queuing theory (theory of waiting lines) and analyze the effectiveness of the system after the implementation of the CRM system. Because for the company, the result of improving information interaction is a priority task.

Let's start with indicators before the implementation of the CRM program:

- 1) average intensity of incoming information flows to applications during an eight-hour working day: $\lambda = 64$;
- 2) LIS maintenance in normal mode: $\mu = 18$;
- 3) intensity of incoming data flow per hour: $\lambda = 8$ applications;
- 4) the intensity of the load on the LIS of one department: $\rho = 0,44$;
- 5) average number of applications received during the hour: $\bar{k} = 0,78$;
- 6) the average number of requests in the queue: $\bar{v} = 0,34$;
- 7) probability of formation of a queue: $r_{ch} = 0,19$;
- 8) average waiting time in the queue: $\bar{t}_{och} = 0,042$;
- 9) average length of stay of an application in LIS: $\bar{t}_{cmo} = 0,167$;
- 10) coefficient of downtime of information flows in LIS: $\kappa_{pr} = 0,56$.

The obtained result shows that on average 56% of the working time of the LIS of one branch of LLC DSV Logistics is idle. So, based on the indicators calculated above, it can be concluded that the department works less efficiently. This is indicated by a number of indicators, the main of which include the network load intensity indicator, the average intensity of incoming information flows and LIS maintenance in normal mode.

We will conduct a detailed recalculation of the performance indicators of the same branch of LLC DSV Logistics after the implementation of the CRM program, which aims to attract new and develop existing customers.

The average intensity of incoming information flows increased by 2,66 times, which is now equal to applications in $\lambda = 170$ per eight-hour working day. The capacity of the LIS itself in normal mode (that is, without the formation of a queue) has increased by 2,22 times and now it can serve applications in an hour $\mu = 40$.

An hour is selected for the unit of time for transmitting and receiving information in the LIS, the intensity of the incoming data flow during this period of time $\lambda = 30$, it has increased by 3,75 times and will be equal to requests/hour. Then the intensity of the load ρ on the LIS of one department will be equal to:

$$\rho = \frac{\lambda}{\mu} = \frac{30}{40} \approx 0,75.$$

In our case $\rho = 0,75 < 1$, this means that during the operation of the LIS there will be gaps in the absence of information flows in the queue, that is, the LIS is idle.

Knowing the intensity of the ρ load on the LIS channels, we will determine the average number of applications received by the LIS within an hour \bar{k} .

This value is equal to:

$$\bar{K} = \frac{\rho}{1-\rho} = \frac{0,75}{0,25} \approx 3 .$$

Similarly, we calculate the average number of requests in the queue \bar{V} . So,

$$\bar{V} = \bar{k} - \rho = 3 - 0,75 = 2,25 .$$

We will also calculate the probability of queue *rch* formation in LIS communication channels:

$$Rch = \rho^2 \approx 0,56.$$

The average waiting time in the queue \bar{t}_{och} is calculated under the following conditions:

$$\bar{T}_{och} = \frac{\bar{v}}{\lambda} = \frac{2,25}{30} = 0,075 \text{ (hours)}.$$

When evaluating this result, we take into account the fact that the probability of the formation of a queue is relatively small ($r_{ch} = 0,56$).

The average length of stay of an application in the LIS \bar{t}_{cmo} is calculated as follows:

$$\bar{T}_{cmo} = \bar{t}_{och} + \frac{1}{\lambda} = 0,075 + \frac{1}{30} = 0,108 \text{ (hours)} .$$

Let's calculate the idle rate of information flows in LIS κ_{pr} , which is equal to:

$$K_{pr} = 1 - \rho = 1 - 0,75 = 0,25 .$$

The obtained result shows that, on average, 25% of the working time of the LIS of one branch of LLC DSV Logistics is idle.

Let's determine the average time spent waiting for service (\bar{t}_{vt}) of all information flows that enter the LIS of one department during an eight-hour working day:

$$\bar{T}_{vt} = T \times \bar{v} = 8 \times 2,25 = 18 \text{ (hours)} .$$

So, based on the indicators calculated above, it can be concluded that the logistics information system of LLC DSV Logistics works effectively. This is indicated by a number of indicators, the main ones include the network load intensity indicator. In our case, it is equal to 0,75. If this indicator were equal to one, it would indicate that our LIS is loaded at 100%. The calculated value of the load intensity is less than one, therefore gaps in the absence of information flows are formed in the LIS, and the average time of one information message in the queue is 0,108 hours.

At this intensity of LIS load, the probability of queue formation is 0,56, and the average waiting time in the information flow queue is 0,075. These indicators indicate that with such a number of information flows per hour, there is no queue in our LIS, that is, there is no accumulation or idleness of information. The results of the LIS LLC DSV Logistics study indicate that the network is not loaded with incoming information flows at 100% and its idle time is 0,25 hours.

The use of the outlined methodical provisions allows to determine costs in all subsystems of LIS. After all, the information flows that circulate in the LIS form its database, where information about the cost of the product flow and its size, calculation of the optimal order size, costs of storage and inventory management, forecasts of sales volumes and supplier ratings are entered. The use of the methodological approach of the queuing theory (theory of waiting lines), allows for the assessment of the effectiveness of the activities of the Forestry. With its help, you can determine the optimal level of information interaction within the communication channels of any enterprise.

Comparison of the efficiency indicators of the information system of LLC DSV Logistics before and after the implementation of the CRM system is indicated in table 3.12.

Table 3.12 - Comparison of indicators before and after the CRM system implementation

№	Indicators	Before implementation	After implementation
1	Average intensity of incoming information flows	64 applications/8 hours	170 applications/8 hours
2	Load intensity on LIS channels	0,44	0,75
3	Average number of requests during the hour	0,78	3
4	Average number of requests in the queue	0,34	2,25
5	Probability of the formation of a queue in the commune LIS channels	0,19	0,56
6	Average waiting time in the queue	0,042	0,075
7	Average duration of an application in the LIS	0,167	0,108
8	Idleness ratio of information flows in LIS	0,56	0,25
9	Average time spent waiting for the service of all information flows that arrive in the LIS	25	18

As a result, according to the table, we have significant improvements in such indicators as: average intensity of incoming information flows for an 8-hour working day; the average number of applications during the hour; the average period of stay of the application in the LIS; idleness ratio of information flows in LIS; average time spent waiting for the service of all information flows that arrive in the LIS. But, unfortunately, we have to sacrifice the reduction of load intensity indicators on LIS channels; the average number of applications during the hour; the probability of queue formation in communication channels and the average waiting period in the LIS queue.

3.4 Chapter 3 summary

Challenges for the logistics industry appeared a few years before the new stage of the Russian-Ukrainian war. Due to the pandemic, the market began to accelerate localization and transfer of supply chains closer to the country of production or sale of products. But in 2022, companies had to make decisions as quickly as possible.

There is a dissonance in the warehouse real estate market of Ukraine: warehouses are in demand, but finding, analyzing and choosing the optimal business premises is complicated. It takes weeks and months to select real estate, and the chance of falling for an unscrupulous warehouse owner or broker is extremely high.

Therefore, the Warehousing service, which simplifies work with warehouse operations, from the company WareTeka, with which LLC DSV Logistics will cooperate, came to the rescue. This is a service that simplifies cooperation with logistics operators. It enables small and medium-sized businesses to make deals with 3PL operators online.

We offer to improve the quality of services based on the implementation of the CRM system from the Ukrainian manufacturer "FIRMAO". The main goal of implementing a CRM strategy is to create a single ecosystem for attracting new and developing existing customers. Managing relationships means attracting new

customers, turning neutral buyers into loyal customers, forming business partners from regular customers. The main advantage of a CRM system is that it can benefit almost any organizational unit - from sales and customer service to recruiting, marketing and business development. Storing all information about customers in one place, registering service problems, identifying sales opportunities, managing marketing campaigns - these are just a few of the possibilities provided by CRM. Based on the results of the implementation of the CRM system, the effectiveness of the chosen solution according to the proposed concept was calculated.

Analysis of the activity of LIS LLC DSV Logistics with the help of the queuing theory (theory of waiting lines), mathematical apparatus allows to get a complete picture of the functioning of LIS and conduct a constructive analysis of its work. Decisions made on the basis of such an analysis will affect the efficiency of the logistics information system LLC DSV Logistics as a whole.

CONCLUSIONS AND RECOMMENDATIONS

It was found that in the management of the enterprise, information provision serves as an important element that affects the development of communication processes, since information is a connecting link of management, and it contains the information necessary for assessing the situation and making management decisions. The organization of information support is related to the definition of quality characteristics, which are established on the basis of certain criteria. Information quality criteria include: content, perception, adequacy.

It is determined that the supply chain reflects every single operation in the production and delivery of the final product, starting from suppliers who produce materials for a supplier of a particular enterprise, and ending with its consumers. By creating a supply chain management system, companies aim to improve customer service, increase the accuracy of forecasts, reduce the volume of goods in warehouses, reduce costs, and also reduce the time it takes to release goods to the market. The effective process of managing such a logistics system should be based on the collection of information about the managed object, its analysis, preparation and adoption of management decisions, as well as control and organization of the implementation of these decisions. This requires high-quality information support of the enterprise,

The world experience of using information programs for the interaction of supply chain participants was studied. In the information technology market, many leading manufacturers offer their own tools for solving integration problems at different levels, such as business process integration (BusinessProcessIntegration - BPI), enterprise application integration (EnterpriseApplicationIntegration - EAI), enterprise platform integration (PlatformIntegration - EPI), data integration or, as it is often called, integration corporate information (EnterpriseInformationIntegration - EII). The most widespread modern complex software systems in the world are systems of: enterprise resource planning class (Enterprise Resource Planning - ERP), which provide

management of all enterprise processes; class of enterprise relationship management (Supply Chain Management - SCM), which provide management of logistics chains.

The object of research is forms of information interactions between DSV Logistic LLC and supply chain participants.

DSV Panalpina A/S completes DKK 30.2 billion acquisition of Global Integrated Logistics from Agility. All conditions and requirements for the acquisition of Agility's Global Integrated Logistics business (GIL) have been met, and DSV Panalpina A/S (DSV) is now formally taking over GIL from Kuwait-based Agility. With the acquisition of GIL, DSV is becoming a global top-three player within transport and logistics and the aim is to continue to grow the business from this strong position.

GIL has an annual revenue of DKK 29 billion (USD 4.6 billion) with Air & Sea freight as the main contributor. This will be added to DSV's existing global network. Moreover, the inclusion of GIL is building on DSV's presence in both APAC and the Middle East. With 1.4 million square meters of warehousing capacity, GIL will be a strong addition to DSV Solutions, while the road freight activities in Europe and the Middle East will strengthen the DSV Road network.

The combined DSV and GIL business is aiming to use the strengthened position in the market to continue to grow through enhanced service offerings for customers, market-leading IT infrastructure and economies of scale.

We offer to improve the quality of services based on the implementation of the CRM system, which provides for effective interaction with the client. Based on the results of the implementation of the CRM system, the effectiveness of the selected Megaplan solution based on the proposed concept was calculated. Target indicators of CRM measures of the organization are established based on its position on the market and financial results: reduction of labor costs for the production of services; stabilization of mutual relations and reduction of complaints from representatives of the local community about the company's activities, reduction of the number of fines; activation of personnel potential; improving the quality of procurement of goods and services, reducing unused stocks.

The implementation of the CRM system was accompanied by the creation of a working group of employees to ensure maximum integration of internal business processes with the IT solution. In our case, a "working group" was created, which for four months participated in the development of the CRM system together with the consulting department of the integrator. The team included 5 people: the director of the main branch, the heads of the sales, marketing, back office and IT departments. Members of the "working groups" spent about 25% of their time during four months.

To determine the efficiency of LLC DSV Logistics LIS, the toolkit of the queuing theory (theory of waiting lines) was used. For this purpose, we will consider our LIS as a logistics web system. After all, LIS LLC DSV Logistics is a locally distributed web system, which consists of a large number of web servers and mechanisms for routing incoming information flows among several server nodes. Analysis of the activities of LLC DSV Logistics with the help of the mathematical apparatus of queuing theory (theory of waiting lines), allows you to get a complete picture of the functioning of the LIS and conduct a constructive analysis of its work. Decisions made on the basis of such analysis will affect the efficiency of LLC DSV Logistics 's logistics information system as a whole.

REFERENCES

1. Antipenko E. Yu. Project-oriented organizational structure of supply chain management as a method of increasing the competitiveness of the enterprise / E. Yu. Antipenko, O. V. Vorontsova // *Nauk. release Chernihiv state Institute of Economics and Management. Ser. Economy.* - 2013. - Issue 2. - P. 109-113.
2. Bilotserkivskiy O. B. Logistics: teacher. manual / O. B. Bilotserkivskiy, P. V. Brin, O. O. Zamula, N. V. Shiryayeva; National technical "Khark" University polytechnic institute". - Kh., 2010. - 152 c.
3. Bochkovsky A. P. Management, marketing and logistics: teaching. manual / A. P. Bochkovskiy, N. Yu. Sapozhnikova; Odessa national polytechnic Univ. - Odesa: Jurid. lit., 2016. - 225 c.
4. Vaselevsky M. Supply chain of products of industrial enterprises: formation and support systems: autoref. thesis ... Dr. Econ. Sciences: 08.00.04 / M. Vaselevskiy; National Lviv University. polytechnic". - L., 2012. - 42 c.
5. Voznenko N. I. Theoretical aspects of the formation of the organizational and economic mechanism of adaptive management of the logistics system of the enterprise / N. I. Voznenko // *Business Inform.* - 2015. - No. 12. - P. 206-214.
6. Garafonova O.I. Peculiarities of flow management in logistics systems of industrial enterprises / O. I. Garafonova // *Nauk. release Forested* - 2015. - Issue 4. - P. 51-55.
7. Girna O. Supply chain and formation of added value based on a client-oriented approach / O. Girna, N. Glynskiy // *Visn. National Lviv University. polytechnic".* - 2013. - No. 762. - P. 41-46.
8. Horbenko O. V. Logistics: teaching. manual / O. V. Horbenko. - Kyiv: Znannia, 2014. - 315 p.
9. Goshchinska D. Ya. Information and communication support of cluster interaction of enterprises: autoref. thesis ... candidate economy Sciences: 08.00.04 / D. Ya. Goshchinska; Govt. University of Telecommunications. - Kyiv, 2016. - 20 c.

10. Gutorov O. I. Logistics: teaching. manual / O.I. Gutorov, O.I. Lebedynska, N. V. Prozorova; Hark. national agrarian University named after V.V. Dokuchaeva - Kh.: Myskdruk, 2011.- 322 c.
11. Zhivko Z. B. Logistics: teacher. manual / Z.B. Zhivko; Lviv. state University of Internal Affairs affairs - Lviv: LvDUVS, 2015. - 191 p.
12. Zagorodnya Yu. V. Effectiveness of interaction of industrial enterprises with logistics centers: autoref. thesis ... candidate economy Sciences: 08.00.04 / Yu.V. Backyard; DVNZ "Priazov. state technical Univ. - Mariupol, 2016. - 20 c.
13. Ivanova M. Paradigm as a model of logistics development research / M. Ivanova // Nauk. Visn.. - 2015. - No. 10. - P. 95-109.
14. Ilchenko N.B. Logistics strategies in trade: a monograph / N.B. Ilchenko; Kyiv. national trade and economy Univ. - Kyiv: Kyiv. national auction. University, 2016. - 431 p.
15. Information systems and technologies: education. manual Part 1 / V. D. Danchuk, N. M. Naumova, N. O. Dorozhko; National transp. Univ. - K.: NTU, 2012. - 195 c.
16. Katerna O.K. Intellectualization of transport and logistics activity in a unified information space / O. K. Katerna // Visn. National Lviv University. polytechnic". - 2014. - No. 811. - P. 150-155.
17. Kachurovsky V. E. Information logistics / V. E. Kachurovsky // Visn. National Lviv University. polytechnic". - 2010. - No. 690. - P. 53-58.
18. Kindiy M.V. Management of supply chains of trade networks on the basis of category management / M.V. Kindiy, Y.V. Malysh, L.P. reception //Visn. National Lviv University. polytechnic". - 2015. - No. 833. - P. 143-152.
19. Koval T. A. Study of marketing of partnership relations as a tool of strategic management of the enterprise / T. A. Koval, V.P. Yakhkind //Business Inform. - 2014. - No. 4. - P. 441-448.
20. Kolodizeva T.O. Definition of supply chains and their role in increasing the efficiency of logistics activities of enterprises / T.O. Kolodizeva // Problems of economy. - 2015. - No. 2. - P. 133-139.

21. Kochubey D.V. Evaluation of the effect of the implementation of logistics information systems/ D.V. Kochubey // Business Inform. - 2014. - No. 6. - P. 228-232.
22. Kryvyovyazyuk I. V. Management of logistic information systems of the enterprise: monograph / I. V. Kryvyovyazyuk, O. R. Uskov; MONMS of Ukraine, Luts. national technical Univ. - L.: Manuscript, 2011. - 139 c.
23. Krykavskyi E.V. Logistics for economists: a textbook / E.V. Krykavskyi; National Lviv University. polytechnic". - 2nd ed., ed. and added - Lviv, 2014. - 475 c.
24. Krykavskyi E. V. Economics of logistics: teaching. manual / E.V. Krykavskyi, O. A. Pokhilchenko, N. V. Chornopyshka, O. S. Kostyuk, N. B. Savina; ed.: E. V. Krykavskyi, O. A. Pokhilchenko; National Lviv University. polytechnic". - Lviv, 2014. - 637 c.
25. Krykavskyi E.V. Marketing information: textbook / E.V. Krykavskyi, O. V. Deinega, I. O. Deinega, L. O. Shelyuk, O. A. Kratt, R. Patora; National Lviv University. polytechnic". - Lviv, 2014. - 414 c.
26. Krykavskyi E. V. From cold logistics to cold supply chains / E. V. Krykavskyi, T. V. Nakonechna // Visn. National Lviv University. polytechnic". - 2016. - No. 846. - P. 79-84.
27. Kuzyo, N.E. Information support of the supply chain modeling process / N.E. Kuzyo, A.I. Chukhrai // Visn. National Lviv University. polytechnic". - 2015. - No. 623. - P. 124-129.
28. Logistics: education. manual / [K.V. Melnikova and others] ; in general ed. Dr economy Sciences, Prof. O. M. Yastremska; Kharkiv. national economy University named after Kuznets seeds. - Kharkiv: HNEU named after S. Kuznetsa, 2015. - 271 p.
29. Logistics. Basic concepts of logistics: a summary of lectures for students studying in the field of preparation. "Management" / N.I. Nikhosyan, O.O. Demydova, V. V. Tytok, M. O. Shebek, T. S. Rudnyk; MONMS of Ukraine, Kyiv. national University of Architecture and Architecture. - K.: KNUBA, 2013. - 27 p.
30. I. P. Mishchuk Formation of logistics systems of trade enterprises: theory and practice: monograph / I. P. Mishchuk. - Lviv: Publishing House of the Lviv Commercial Academy, 2015. - 450 p.

31. Nakonechna T. V. Information technologies in chain management supplies of industrial enterprises / T. V. Nakonechna // *Visn. National Lviv University. polytechnic*". - 2015. - No. 669. - P. 217-222.
32. Nechaev G. I. Supply chain management: training. manual / G.I. Nechaev, S. V. Kuzmenko, Y. V. Sokolova, S. P. Cherednychenko; Eastern Ukraine national University named after V. Dalya. - Luhansk: Knowledge, 2009. - 160 c.
33. Nefyodov M. A. Logistics: academic. manual for university students / M.A. Nefyodov, S. V. Ocheretenko; Kharkiv. national automobile road Univ. - Kharkiv: Khnadu, 2013. - 163 p.
34. Basics of logistics: teaching. manual / Ya. I. Bedrii, E. M. Tarnavskiyi, S.M. Trygub, V. F. Khodakovskiyi. - Kherson: OLDI-PLUS, 2015. - 258 c.
35. Parkhayeva N.V. Marketing and logistics complex of the goods supply system / N.V. Parkhayeva // *Economy of Ukraine*. - 2016. - No. 4. - P. 122-133.
36. Pashkevich M. S. Comparison of the supply chain of a production and service enterprise / M. S. Pashkevich // *Business Inform*. - 2015. - No. 1. - P. 235-240.
37. Popovychenko I. V. Supply and distribution chain management / I. V. Popovychenko // *Visn. Dnieper state Acad. building and architecture*. - 2014. - No. 4/5. - P. 27-31.
38. Prokudin O. G. Information technology for ensuring the functioning of transport logistics of a manufacturing enterprise: autoref. Diss. of Cand. technical Sciences: 05.13.06 / O. G. Prokudin; National transp. Univ. - Kyiv, 2015. - 21 c.
39. Roslavytsev D. M. Project analysis: functional aspects of the implementation of projects of transport systems and logistics: training. manual / D.M. Roslavytsev; Kharkiv. national Acad. urban farm - Kharkiv: KhNAMG, 2013. - 217 p.
40. Savina N. B. Information and financial provision of investment logistics systems / N. B. Savina // *Visn. National Lviv University. polytechnic*". - 2010. -No. 669. - P. 310-316.
41. Savchenko Yu. T. Formation of the strategy of development of enterprises in the supply chain / Yu. T. Savchenko // *Visn. National Lviv University. polytechnic*". - 2014. - No. 811. - P. 316-324.

42. Skitsko V.I. Electronic logistics as a component of modern business / V.I. Skitsko // Business Inform. - 2014. - No. 7. - P. 309-314.
43. Stankevich O. A. Models and information technology of strategic management of distribution logistics: autoref. thesis ... candidate technical Sciences: 05.13.06 / O. A. Stankevich; National technical "Khark" University polytechnic institute". - Kh., 2013. - 20 c.
44. Stupak I. O. Strategic aspects of forming relationships with suppliers / I. O. Stupak // Visn. National Lviv University. polytechnic". - 2015. - No. 690. - P. 453-457.
45. Struk N. Assessment of competitiveness in the system of analysis of prospects of business partnership of enterprises / N. Struk // Bulletin of Lviv National University. Series Economic. - Lviv, 2008. - Issue 37(1). - P. 89 - 93.
46. Sumets O. M. Logistics systems and supply chains: academic. manual for students University / O. M. Sumets, T. Yu. Babenkova; Hark. national technical University of Villages farm named after P. Vasylenko. - 2nd ed., pp. - X: KP "Miska druk.", 2013. - 193 c.
47. Sumets O.M. Supply chains: organizational aspect / O.M. Sumets; Hark. national technical University of Villages farm named after P. Vasylenko. - Kh.: Myskdruk, 2011. - 52 c.
48. Sukhomlinov A. I. Material flow modeling in production logistics / A. I. Sukhomlinov // Processing systems. information - 2013. - Issue 2. - P. 294-298.
49. Sukhomlinov A. I. Problems of modeling logistics and designing information systems of production logistics / A. I. Sukhomlinov // Processing systems. information - 2013. - Issue 5. - P. 162-169.
50. Tatarчук M.I. Corporate information systems: textbook / M.I. Tatarчук; State Higher Secondary School "Kyiv". national economy University named after V. Hetman". - Kyiv: KNEU, 2014.- 329 c.
51. Tankov K.M. Strategic approaches to the formation of relationships in supply chains / K.M. Tankov, O.V. Bahurets // Problems of Economics. - 2011. - No. 2. - P. 58-63.

52. Ukrainian L. O. Development of the methodology of planning suppliers of an industrial enterprise / L. O. Ukrainian, E. A. Korshunov // Probl. economy. - 2013. - No. 2. - P. 145-152.
53. Falovych V. A. Warehouse management in the supply chain: between costs and utility / V. A. Falovych // Visn. National Lviv University. polytechnic". 2014. - No. 811. - P. 438-445.
54. Falovich V. A. New challenges in the development of supply chains /V.A. Falovych //Visn. Priazov state technical university Ser. Econ. science - 2015. - Issue 25. - P. 47-54.
55. Fedorovych O. E. Information support of the logistics of supplies of a manufacturing enterprise: [scholarship. manual] / O. E. Fedorovych, O. V. Maleeva, A.V. Elizeva; National aerospace University named after M.E. Zhukovsky "Kharkiv. aviation institute". - Kharkiv: KHAI, 2015. - 107 p.
56. Khadzhinova O. V. The mechanism of managing the interaction of industrial enterprises with counterparties in the business network: autoref. dis Dr economy Sciences: 08.00.04 / O. V. Khadzhinova; DVNZ "Priazov. state technical Univ. - Mariupol, 2016. - 35 c.
57. Htei N. I. Formation of the system of logistics service for customers of an industrial enterprise in the supply chain: Autoref. Dis... Cand. economy of science/ N. I. Khtei; National Lviv University. polytechnic". - L., 2007. - 24 c.
58. Chorna M. Logistics in trade enterprises: changing priorities / M. Chorna // Nauk. Visn.. - 2015. - No. 11. - P. 220-227.
59. N. I. Chukhrai Redesign of logistic business processes in supply chains / N. I. Chukhrai, S. I. Matvii // Visn. National Lviv University. polytechnic". - 2014. - No. 811. - P. 403-413.
60. Chuhrai N. I. Carriers or logistics operators? [Electronic resource]. - Access mode:<http://www.translog.com.ua/archive/131/number13/print/1>
61. Shandrivska O. Ye., Kuzyak V. V., Koshkalda A. O. Structuring of express delivery services in Ukraine // Abstracts of reports X International. science and practice conf.

62. "Marketing and logistics in the management system." – Lviv (November 6-8, 2014): Publishing House of the National University "Lviv Polytechnic", 2014. – P. 553–554.
63. Petryk IV Strategic supply chain management models / IV Petryk // Visn. National Lviv University. polytechnic". - 2016. - No. 848. - P. 145-153.
64. DSV milestones [Electronic resource] - Access mode: <https://www.dsv.com/en/about-dsv/history/milestones>
65. DSV focus areas [Electronic resource] - Access mode: <https://www.dsv.com/en-us/about-dsv/purpose-and-strategy>
66. DSV annual report 2021 [Electronic resource] - Access mode: <https://investor.dsv.com/static-files/6f294f9f-898c-4056-976c-149ef470c8bb>
67. DSV roadshow Q3 2022 [Electronic resource] - Access mode: <https://investor.dsv.com/static-files/3c726d4a-bb31-4106-831d-91884d051867>
68. DSV innovation [Electronic resource] - Access mode: <https://www.dsv.com/en-in/why-dsv/innovation>
69. DSV Ukraine [Electronic resource] - Access mode: <https://www.dsv.com/en/countries/europe/ukraine>
70. DSV completes acquisition of Agil [Electronic resource] - Access mode: <https://investor.dsv.com/static-files/e7bb1c41-059c-43c2-94b8-318017495e9b>
71. DSV INTERIM FINANCIAL REPORT Q3 2022 [Electronic resource] - Access mode: <https://investor.dsv.com/static-files/29e39cf1-a716-40c2-b4be-8fbc1c24ac61>
72. DSV API [Electronic resource] - Access mode: <https://www.dsv.com/en/why-dsv/connectivity/dsv-api>
73. Youcontrol [Electronic resource] - Access mode: https://youcontrol.com.ua/en/catalog/company_details/41567921/
74. WareTeka Warehousing [Electronic resource] - Access mode: <https://wareteka.com.ua/uk/company/wareteka-on-demand/>

75. WareTeka warm warehouse [Electronic resource] - Access mode:
https://wareteka.com.ua/uk/estate_property/ofisno-logistychnyi-kompleks-makarovskyi-61992-kv-m-s-kolonshchyna/

76. Firmao CRM program [Electronic resource] - Access mode:
<https://firmao.com.ua/crm.php>

77. 4 pl services [Electronic resource] - Access mode: <https://rutair.com/4pl-services-2>

78. What is CRM [Electronic resource] - Access mode:
<https://nethunt.ua/blog/shcho-takie-crm-sistiema-povonii-ghid-po-viboru-crm-dlia-pochatkiivtsiv-v-2020/>

Appendix A

Table 1 - The main parameters of information flows that reflect the needs of the LLC DSV Logistics branch for a month

Names of information flows	Content and purpose of information flows	Documents included in information flows	Information flow parameters		
			amount, Kilobyte	speed, Kilobit/s	intensi, Earls
1	2	3	4	5	6
Information flows, what reflect requirements for goods	<ol style="list-style-type: none"> 1. Requirements to the assortment. 2. Quality products and service standards 	<ul style="list-style-type: none"> -ABC analysis of goods; -technological instructions regarding acceptance, storage and sale of goods; -supporting documents quality 	1400 x 23,5= 32900	68	0,81
Price of information flows	<ol style="list-style-type: none"> 1. Range prices for competitive types of goods. 2. Conditions contracts or supply contracts that relate to prices. 	<ul style="list-style-type: none"> -price lists of suppliers; -magazines income commodity values; -inventory 	1200 x 23,5 = 28200	68	0,81
Information flows, what reflect process orders goods	<ol style="list-style-type: none"> 1. Information about availability goods in distribution centers or in warehouses. 2. Volumes of orders and assortment specifications. 3. Minimum orders for goods. 4. Order collection scheme.Communication channels for collecting orders.Specifications and frequency of orders.Return scheme orders 	<ul style="list-style-type: none"> -application for goods; -magazine powers of attorney; -documents for suppliers; -magazines planning procurement; -sales analysis; -data on sold goods 	2300 x 23,5 = 54050	68	0,81
Information flows, what reflect the process supplygoods	<ol style="list-style-type: none"> 1. Duration of the order fulfillment cycle. 2. Frequency of delivery of ordered goods. 3. Requirements for fulfilling orders in full and for the scheme of receiving orders. 4. Order return scheme; Requirements for the quality of supplies and pre-sale and after-sale 	<ul style="list-style-type: none"> -order status report; -documents on the conditions of supply of goods; order confirmation; -notification of non-confirmation of the application commodity report; book sale. 	2100 x 23,5= 49350	68	0,81